

Firestone

AIRIDE



AIR SPRING

REPLACEMENT GUIDE

firestoneairide.com

800-888-0650

THE COMPLETE SOLUTION FROM THE ORIGINAL AIR SPRING

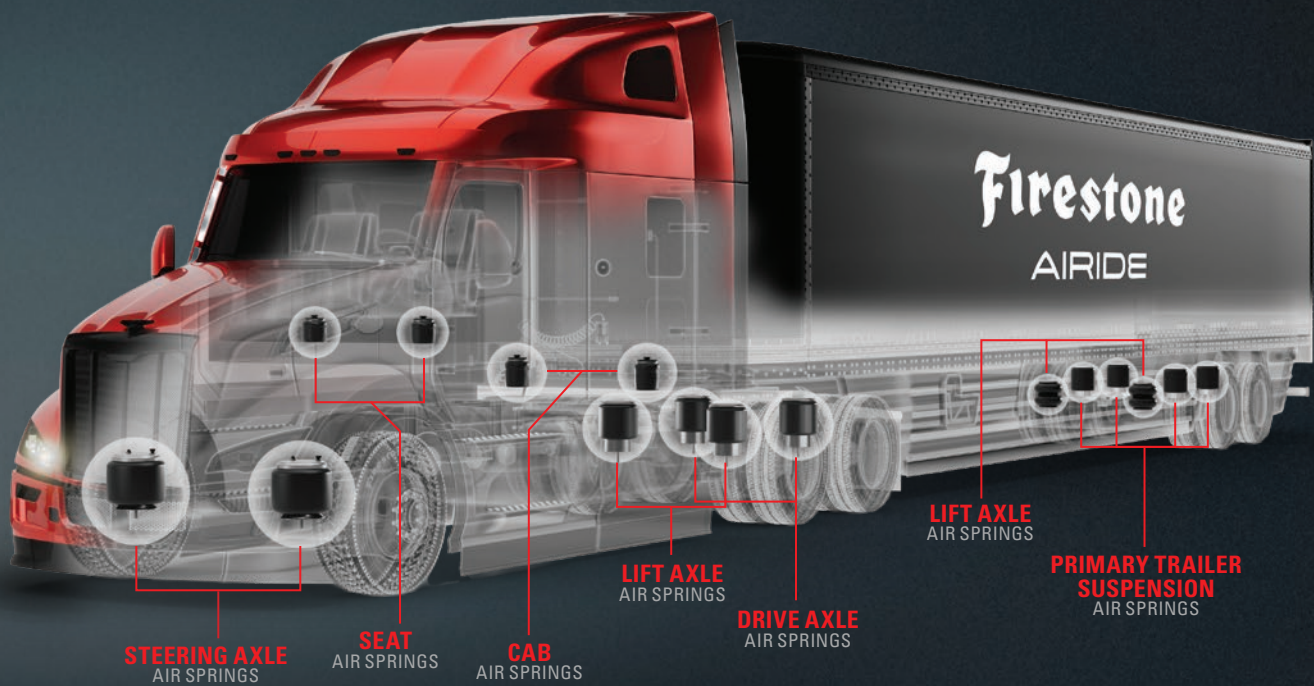

Airide™ springs were pioneered by Firestone and perfected over the last 85 years. Given the wide adoption of Airide springs on practically all truck and trailer manufacturers, **only Firestone offers the complete replacement solution.**

Firestone

AIRIDE



TABLE OF CONTENTS

COMPONENTS & PART DIAGRAMS

Introduction	4
Airide Spring Components	6
Airide Spring Styles & Identification.....	7
General Specifications	8
Alignment Definitions	9
PRIMARY TRUCK & TRAILER AXLE	
1T Reversible Sleeve Springs	10
Parts Tables	12
AUXILIARY / TAG AXLE	
Convolute Springs	94
Single Convolute	96
Double Convolute	98
Triple Convolute.....	119
CAB & SEAT	
Sleeve Style Springs	128
Parts Tables	130
STEERING AXLE	
Sleeve Style Springs	148
Parts Tables	150

CROSS REFERENCES

PRIMARY TRUCK & TRAILER, AUXILIARY / TAG AXLE	
Manufacturer to Firestone No.	152
Goodyear Assembly No. to Firestone.....	182
Goodyear Bellows No. to Firestone	192
Contitech Assembly No. to Firestone.....	200
Bellows Index by Bellows No.	206
1T Bellows Index by C01 Bellows No.....	210
Bellows Index by Size	216
PRIMARY TRUCK & TRAILER PISTON	
Index by Piston Component No.	220
Index by Piston Drawing No.	234
CAB & SEAT	
Index by Manufacturer	248
Index by Cap Drawing No.	250
Index by Piston Drawing No.	252
Index by Cap Component No.	254
Index by Piston Component No.	256
OE Suspension Index	258
All Parts Assembly Order No. Index.....	264
WARRANTY AND MAINTENANCE	
Warranty	270
Preventive Maintenance Checklist.....	273

WHEN EVERYTHING RIDES ON IT, TRUST FIRESTONE



For over 80 years, Firestone has been the trusted partner of commercial trucks and trailers around the globe. With our industry experience, as well as our international customer base, you can trust Firestone's quality, reliability, and service.

It's value for the long haul.



QUALITY

While air springs may appear simple, they are actually a highly sophisticated and complex product. Firestone Airide springs are engineered to meet the strictest standards, no matter where you are located. Our extensive experience utilizing high-strength fabric and rubber compounds allows us to provide you with the confidence of a long-lasting, trouble-free air spring. To support this confidence, Airide springs are rigorously tested to OEM requirements, as well as our own. **It's an obsession with quality you can only expect from a leader.**



RELIABILITY

Firestone allows you to buy with confidence. We engineer and manufacture each product to provide years and thousands of miles of trouble-free service. OEMs trust Firestone's production and testing standards, which carries over into our aftermarket products. In fact, Firestone air springs often outlast other maintenance items on your suspension. With our industry-leading five-year warranty, we stand behind the durability and quality of our products. **Airide air springs will give you peace of mind on your journeys, no matter where they take you.**



SERVICE

We not only pride ourselves on high-quality products, but also our commitment to serving our customers and the industry. Therefore, we have the extensive service arm that goes along with our global manufacturing footprint. As an organization, we consistently strive to serve our customers and the market as best as possible. Our mission is to support distributors and end customers with training and product identification help, such as this application guide, as well as any other replacement needs. **You can rely on Firestone as your service partner.**



800-888-0650



1T Reversible Sleeve Example

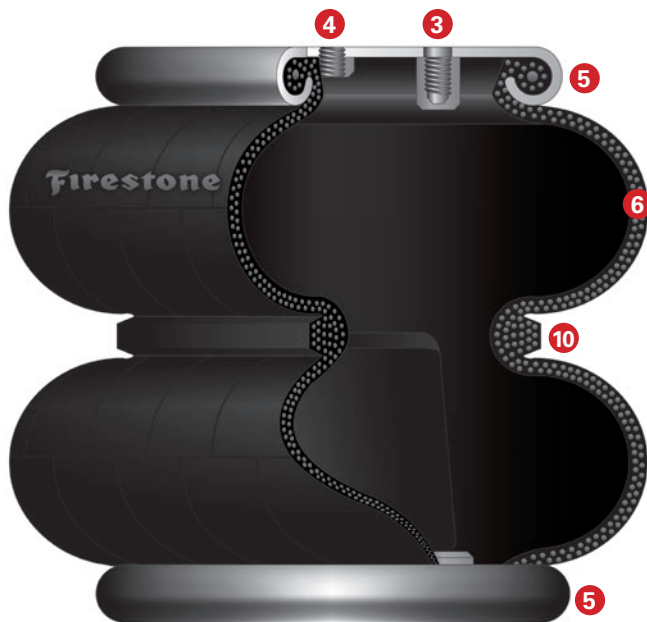

Double Convoluted Example

1. Stud

A permanent part of the bead plate assembly, used to attach the air spring to the suspension.

2. Combo Stud

Combination mounting stud and air fitting.

3. Blind Nut

A permanent part of the bead plate assembly, used to attach the air spring to the suspension.

4. Air Fitting Hole

A tapped hole that provides an air entrance for the part.

5. Bead Plate

Steel plate, permanently crimped to the bellows to form an airtight assembly.

6. Bellows

The air spring bellows is a flexible, airtight composite of rubber and reinforced fabric, which allows the assembly to roll up and down, providing an air-cushioned spring effect within the suspension.

7. Bumper (Optional)

A solid, molded rubber fail-safe device used on many suspension applications. Prevents excessive damage to vehicle and suspension in the case of sudden air pressure loss.

8. Piston

The lower section of the 1T and 1X style of air spring made from aluminum, steel, or fiber reinforced composite. Provides lower mounting arrangement for the air spring in the form of tapped holes or studs.

9. Piston Bolt

Attaches the piston to the bellows assembly. Extended on the bottom of the piston, in some cases, to serve as a means of attaching the spring to the suspension.

10. Girdle Hoop

A ring molded into the bellows of the convoluted type air spring.

ASSEMBLY ORDER NUMBER & BELLOWS NUMBER

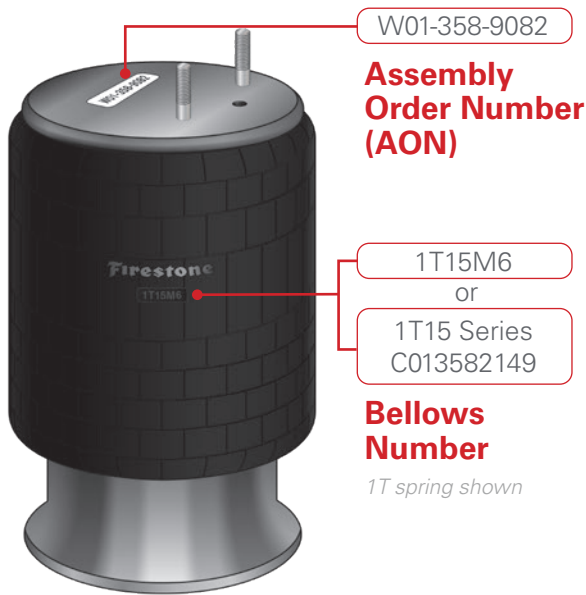

To identify an Airide spring for replacement, find the Assembly Order Number (AON) on the label adhered to the bead plate (e.g., W01-358-9082). This number is used for ordering purposes. Do not confuse this with the stamped 8-digit bead plate number. See page references below for detailed instructions on identifying your air spring.

For 1T and Convoluted springs, the bellows number is typically molded directly underneath the Firestone logo and tells exactly which bellows is needed.

1T spring samples:	Convoluted spring samples:
<ul style="list-style-type: none"> • 1T15M6 or 1T19L7 • 1T15 Series, C013582149 	<ul style="list-style-type: none"> • 113, 20, or 312

This number will help narrow your choice of assemblies to just a few.

Start by identifying your style of air spring by comparing to the illustrations below. Then, go to the appropriate section of this guide or the cross references for more information on determining the corresponding order numbers.

AIR SPRING STYLES



1T REVERSIBLE SLEEVE

PRIMARY TRUCK & TRAILER AXLE
PAGE 10



CONVOLUTED

AUXILIARY / TAG AXLE
PAGE 94



SLEEVE

CAB & SEAT
PAGE 128



SLEEVE

STEERING AXLE
PAGE 148

Want an online resource for air spring identification? Visit:
firestoneairide.com/product-search-hd-oh/
to use our online air spring identification tool.

FASTENER TIGHTENING SPECIFICATIONS		
Description	Size	Torque (lb-ft)
Bead ring nuts on bolts	5/16-24	17-22
Bead ring nuts on bolts	3/8-24	28-32
Bolts in blind nuts in bead plates	3/8-16	15-20
End of adapter studs in blind nut	3/8-16	15-20
Nut on end of adapter stud	1/2-13	25-30
Studs on bead plates or blind nuts	1/2-13 or 1/2-20 M12 x 1.75	25-30
Bolt to attach piston base to lower mounting surface	1/2-13	25-30
Nut on air entrance stud	3/4-16 M16 x 1.5 M20 x 1.5	40-45
Nut to an entrance stud	1 5/16-12UNF 1 1/4-12UNF	45-50
NPT air supply fitting	1/4 & up	17-22
Nut on end closure lower mounting	3/4-10	45-50

Operational Cautions

Air spring failure can be caused by a variety of situations, including internal or external rubbing, excessive heat, and overextension. For further details, refer to warranty section on page 270.

Temperature/Pressure Range

The ambient operating temperature range for standard vehicular air springs may vary. See the website for temperature ranges for individual parts by part number. The maximum pressure is 100 PSI.

Bumpers

In general, bumpers are used to support the vehicle weight to prevent damage to the flexible membrane during times when no air is in the system. They are also used as stops when the axle is raised by a lift unit. In applications that require frequent bumper contact, consult Firestone.

Downstops and Upstops

Positive stops in both directions (compression and extension) should always be used with Airide™ springs.

1. In **COMPRESSION**, the minimum height shown for each air spring is at, or slightly above the PINCH POINT of the bellows. Here is a #22 shown in the collapsed or “pinch point” condition:

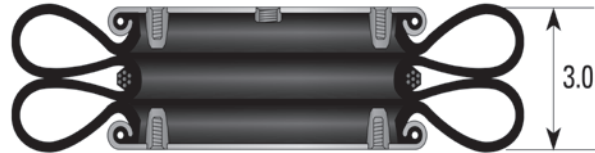

The bellows can be damaged if allowed to constantly bottom out as shown above; therefore, a downstop is required to prevent this. An external downstop can be something as simple as a steel block and should be sized at or slightly greater than the minimum height of the Airide spring. In our #22 example, the block would need to be at least 3.0 inches high. If an external downstop cannot be used, many parts are available with internal rubber bumpers.

2. In **EXTENSION**, an upstop is necessary to prevent the air spring from overextending. The reasons for this are two-fold:
 - a) the life of the bellows may be reduced, and
 - b) the crimp may open up, allowing the bellows bead to blow out of the metal end closure.
 There are many ways to design-in an upstop, including shocks, chain, a cable or strap, contacting a metal stop, etc.

Contaminates

Shielding should be used to protect the bellows from exposure to hot metal, sand, petroleum base fluids, acids, etc. Please consult Firestone if you wish to know how the bellows will withstand a specific contaminant. (For liquids such as acids, it is important to know both concentration and temperature.)

Storage

The best storage environment is a dark, dry area at normal room temperature.

Air Spring Alignment

Alignment is based on the orientation of the lower bead plate or piston compared to the upper bead plate. Alignments other than those shown are noted in the bottom view.

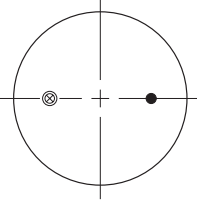
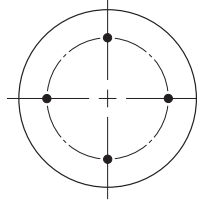
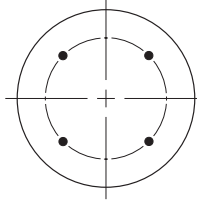
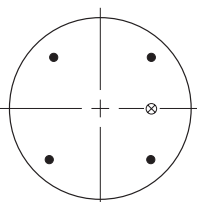
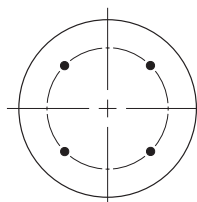
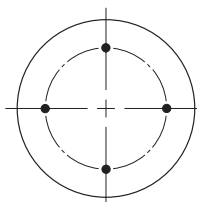
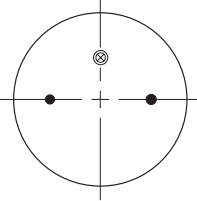
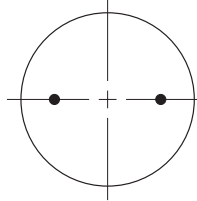
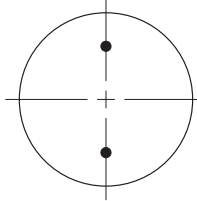
BEAD PLATE TOP VIEW	BEAD PLATE OR PISTON BOTTOM VIEW	
	PARALLEL ALIGNMENT	45° ALIGNMENT
		
		
		90° ALIGNMENT
		

WARNING

DO NOT INFLATE ASSEMBLY WHEN IT IS UNRESTRICTED. ASSEMBLY MUST BE RESTRICTED BY SUSPENSION OR OTHER ADEQUATE STRUCTURE. DO NOT INFLATE BEYOND PRESSURES RECOMMENDED IN DESIGN LITERATURE (CONTACT FIRESTONE FOR INFORMATION). IMPROPER USE OR OVERINFLATION MAY CAUSE ASSEMBLY TO BURST, CAUSING PROPERTY DAMAGE OR SEVERE PERSONAL INJURY.



The Firestone 1T or Reversible Sleeve type spring is the most popular style used on suspensions.

READING THE PARTS LABEL

1 BELLOWS 1T15M2	2 AON W01-358-9105	7 C01-358-1131	8 12.79	9 Composite
3 CROSS SECTION 	4 BEAD PLATE TOP 	5 PISTON BOTTOM 	10 SERVICE ASSEMBLY W01-358-0725	11 APPLICATIONS: Hendrickson Trailer S1245 Granning 5065 Ridewell 1003589105C Watson & Chalin AS-0015
	6 ORDER NO. WC1-358-1652	12 OBSOLETE: REPLACED BY W01-358-5508		

1. Bellows Number

Identifies the bellows, normally molded directly underneath the Firestone logo.

2. Assembly Order Number (AON)

Located on the label adhered to the bead plate. This number is used for ordering purposes.

3. Cross Section View

Includes dimensional information in inches for **uninflated** diameter, maximum height, and collapsed height. A bumper, shown in black, and bumper drawing number is also referenced, if applicable (i.e., 3159).

4. Bead Plate Top View

Identifies dimensional information in inches, mounting attachments and the internal Firestone reference number for bead plate, stamped on bead plate top.

5. Piston Bottom View

Includes dimensional information in inches, mounting attachments and piston identification numbers.

6. Piston Component Order Number

The number used to order a replacement piston component, if applicable.

7. Bellows Component Number

If present, the C01-xxx-xxxx number identifies the Firestone internal bellows component, and can be referenced to specific AON applications.

8. Assembly Weight

Total weight of the assembly in pounds.

9. Piston Material

Aluminum, Steel, or Composite.

10. Assembly Components

Part numbers for sub-components associated with the assembly.

11. Applications

Vehicle and suspension manufacturers' part numbers for the particular Airide spring.

12. Assembly Notes

Important information if an assembly has been obsoleted and if there is an exact replacement part available, or if it has replaced other parts.

AIR SPRING IDENTIFICATION

Assembly Order Number (AON) 2

The quickest way to identify the air spring is to read the manufacturer or Firestone assembly order number on the label adhered to the bead plate. Do not confuse this with the stamped 8-digit bead plate number.

Bellows Number 1 / 7

If the AON is illegible, read the part number molded on the bellows, normally directly under the Firestone name. The bellows could be identified in two ways; 1) with the "1T15M2" call out, or 2) with a "1T15 Series" call out and a "C01" number identification (e.g. "C013581131"), which would narrow your search to a smaller group of AONs. Then, use the bead plate and piston combination to determine the final AON.

Bead Plate 4

Identify the 8-digit stamped bead plate number. Reference the last 4 digits to find a match. If the number is not legible, use the **bead plate diameter** measurement in this view to further distinguish between assemblies. In addition, verify the alignment of mounting attachments.

Piston Bottom View 5

Compare the **piston identification numbers**, molded inside the piston, to those shown in the "Piston Bottom View" to find a match. You may also reference the piston indexes on pages 220 and 234 to narrow your search.

BOTTOM VIEW

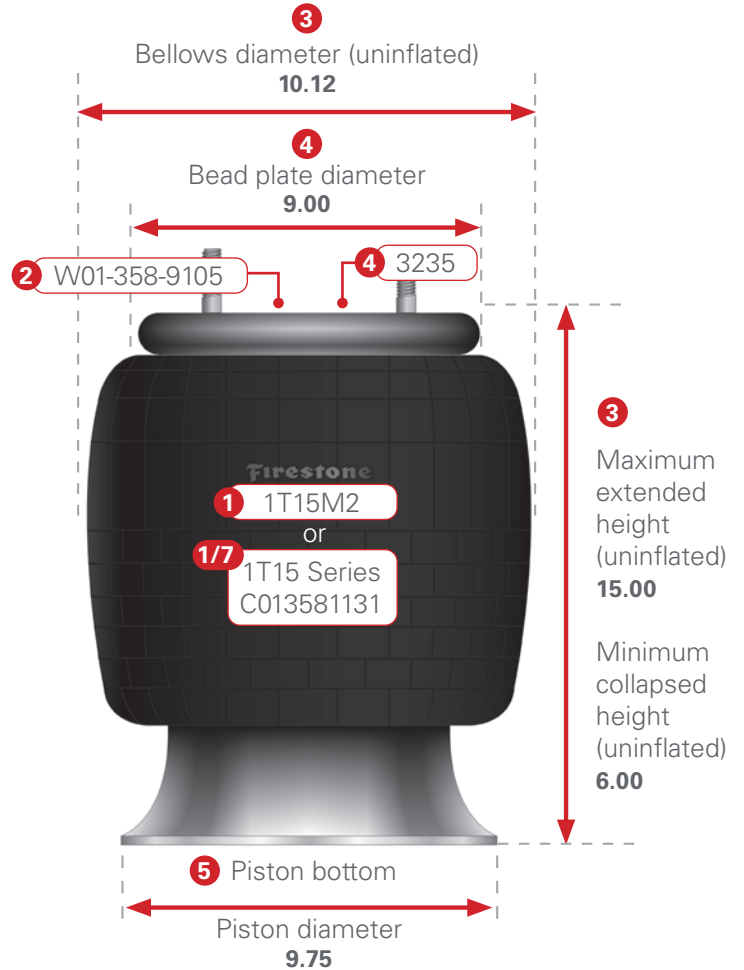
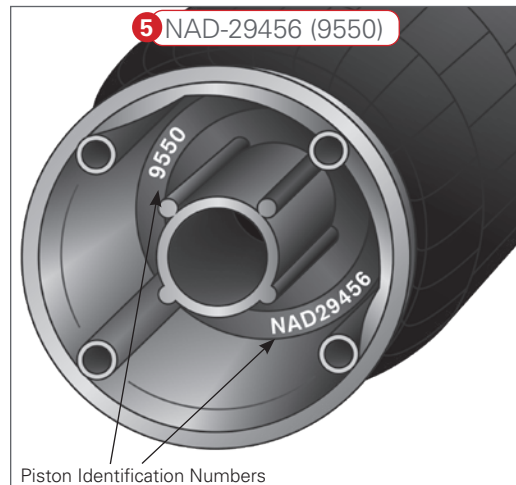

Measure and Reference Cross Section View 3

Should the bellows number be unreadable, the type can still be determined by measuring the **bellows diameter (uninflated)** and comparing this with the 1T styles in the Bellows Index by Size (page 216) until you find a match for the possible bellows. Then, measure the **maximum extended height**, as shown, and compare this with the "Cross Section View" of the parts tables for the general style of possible bellows (1T14, 1T15, 1T17, etc.). To determine if an **internal bumper** is present, measure the minimum collapsed height and compare it to the parts table.

BELLOWS 1T14C1	AON W01-358-2119	C01-358-2112	5.76 Composite
<p>CROSS SECTION</p>	<p>3093</p> <p>BEAD PLATE TOP</p>	<p>9491/FIP-100744</p> <p>PISTON BOTTOM</p>	<p>APPLICATIONS: Granning 5122 Hendrickson Trailer S2394 Rowe Truck ASC1400HL Lift</p>
Order No. WC1-358-0609			

BELLOWS 1T14C1	AON W01-358-2120	C01-358-2112	6.96 Aluminum
<p>CROSS SECTION</p>	<p>3148</p> <p>BEAD PLATE TOP</p>	<p>9651/NBD-11498</p> <p>PISTON BOTTOM</p>	<p>APPLICATIONS: Granning 5691 Granning 6104 (no stud) Rowe Truck ASCS2000 Lift Rowe Trailer ASCST2000</p>
Order No. WC1-358-9095			

BELLOWS 1T14C1	AON W01-358-2131	C01-358-2112	5.58 Composite
<p>CROSS SECTION</p>	<p>3140</p> <p>BEAD PLATE TOP</p>	<p>9491/FIP-100744</p> <p>PISTON BOTTOM</p>	<p>APPLICATIONS: Kelderman</p>
Order No. WC1-358-0609			

BELLOWS 1T14C1	AON W01-358-5310	C01-358-2112	6.28 Aluminum
<p>CROSS SECTION</p>	<p>3079</p> <p>BEAD PLATE TOP</p>	<p>9708/NBD-8626</p> <p>PISTON BOTTOM</p>	<p>APPLICATIONS: American Carrier 9003-001 Hendrickson Trailer S8832 Ridewell 1003585310C Circle R</p>
Order No. WC1-358-0600			

BELLOWS 1T14C1	AON W01-358-5311	C01-358-2112	6.59 Aluminum
<p>CROSS SECTION</p>	<p>3079</p> <p>BEAD PLATE TOP</p>	<p>9708/NBD-8626</p> <p>PISTON BOTTOM</p>	<p>APPLICATIONS: Ridewell 1003585311C</p>
Order No. WC1-358-0600			

HARDWARE KEY

- Bolt or Stud 1/2-13
- ⊗ Air Inlet 1/4 N.P.T.
- ⊗ Combination Stud/Air Inlet Stud Outside Thread is 3/4-16 Pistons
- ⊗ Exception to Standard Stud/Air Inlet Stud Inside Thread of 1/4 N.P.T.

- ▲ No Alignment Specified-Center Stud Mounting is Standard
- ⊗ Threaded Hole 3/8-16 Blind Nut on Bead Plates 1/2-13 Pistons

<p>BELLOWS 1T14C1</p>	<p>AON W01-358-5323</p>	<p>C01-358-2112 6.79 Aluminum</p>
<p>CROSS SECTION</p>	<p>3148</p> <p>BEAD PLATE TOP</p> <p>9708/NBD-8626</p> <p>PISTON BOTTOM</p> <p>Order No. WC1-358-0600</p>	<p>APPLICATIONS: Air Ax (Roelofs) Granning 7504 Ridewell 1003585323C</p>
<p>BELLOWS 1T14C1</p>	<p>AON W01-358-5343</p>	<p>C01-358-2112 6.33 Aluminum</p>
<p>CROSS SECTION</p>	<p>3079</p> <p>BEAD PLATE TOP</p> <p>9651/NBD-11498</p> <p>PISTON BOTTOM</p> <p>Order No. WC1-358-9095</p>	<p>APPLICATIONS: Iveco 504035755</p>
<p>BELLOWS 1T14C3</p>	<p>AON W01-358-5405</p>	<p>C01-358-2185 6.32 Aluminum</p>
<p>CROSS SECTION</p>	<p>3079</p> <p>BEAD PLATE TOP</p> <p>9708/NBD-8626</p> <p>PISTON BOTTOM</p> <p>Order No. WC1-358-0600</p>	<p>APPLICATIONS: Circle R Hendrickson Trailer S9346</p>
<p>BELLOWS 1T14C3</p>	<p>AON W01-358-5406</p>	<p>C01-358-2185 6.69 Aluminum</p>
<p>CROSS SECTION</p>	<p>3140</p> <p>BEAD PLATE TOP</p> <p>9708/NBD-8626</p> <p>PISTON BOTTOM</p> <p>Order No. WC1-358-0600</p>	<p>APPLICATIONS: Granning 1971</p>
<p>BELLOWS 1T14C3</p>	<p>AON W01-358-5408</p>	<p>C01-358-2185 6.26 Aluminum</p>
<p>CROSS SECTION</p>	<p>3096</p> <p>BEAD PLATE TOP</p> <p>9708/NBD-8626</p> <p>PISTON BOTTOM</p> <p>Order No. WC1-358-0600</p>	<p>APPLICATIONS: Jet Company</p> <p>OBSOLETE: NO LONGER AVAILABLE</p>

BELLOWS 1T14C3	AON W01-358-5410	C01-358-2185 8.01 Aluminum
<p style="text-align: center; font-size: small;">CROSS SECTION</p>	<p style="text-align: center;">3140</p> <p style="text-align: center; font-size: small;">BEAD PLATE TOP</p>	<p style="text-align: center;">9778/NAD-18053</p> <p style="text-align: center; font-size: small;">PISTON BOTTOM</p> <p style="text-align: center;">Order No. WC1-358-0686</p>
<p>APPLICATIONS: Granning 2112 Watson & Chalin AS-0029 Ridewell 1003585410C</p>		

BELLOWS 1T14C3	AON W01-358-5412	C01-358-2185 8.20 Aluminum
<p style="text-align: center; font-size: small;">CROSS SECTION</p>	<p style="text-align: center;">3079</p> <p style="text-align: center; font-size: small;">BEAD PLATE TOP</p>	<p style="text-align: center;">9778/NAD-18053</p> <p style="text-align: center; font-size: small;">PISTON BOTTOM</p> <p style="text-align: center;">Order No. WC1-358-0686</p>
<p>APPLICATIONS: American Carrier 8003-011 Oshkosh Neway 90057057</p>		

BELLOWS 1T14C3	AON W01-358-5414	C01-358-2185 8.53 Aluminum
<p style="text-align: center; font-size: small;">CROSS SECTION</p>	<p style="text-align: center;">3148</p> <p style="text-align: center; font-size: small;">BEAD PLATE TOP</p>	<p style="text-align: center;">9778/NAD-18053</p> <p style="text-align: center; font-size: small;">PISTON BOTTOM</p> <p style="text-align: center;">Order No. WC1-358-0686</p>
<p>APPLICATIONS: Air AX (Roelofs) Ridewell 1003585414C</p>		

BELLOWS 1T14C3	AON W01-358-5422	C01-358-2185 7.04 Aluminum
<p style="text-align: center; font-size: small;">CROSS SECTION</p>	<p style="text-align: center;">3079</p> <p style="text-align: center; font-size: small;">BEAD PLATE TOP</p>	<p style="text-align: center;">9708/NBD-8626</p> <p style="text-align: center; font-size: small;">PISTON BOTTOM</p> <p style="text-align: center;">Order No. WC1-358-0600</p>
<p>APPLICATIONS: Circle R</p>		

BELLOWS 1T14C3	AON W01-358-5423	C01-358-2185 7.32 Aluminum
<p style="text-align: center; font-size: small;">CROSS SECTION</p>	<p style="text-align: center;">3148</p> <p style="text-align: center; font-size: small;">BEAD PLATE TOP</p>	<p style="text-align: center;">9651/NBD-11498</p> <p style="text-align: center; font-size: small;">PISTON BOTTOM</p> <p style="text-align: center;">Order No. WC1-358-9095</p>
<p>APPLICATIONS: Granning 5235 Granning 5307 (no stud) Rowe Truck ASC1500/ASCS1500/ ASCS2000 Lift Rowe Trailer ASCT1500/ ASCST1500/ ASCST2000</p>		

HARDWARE KEY

- Bolt or Stud 1/2-13
- ⊗ Air Inlet 1/4 N.P.T.
- ⊗ Combination Stud/Air Inlet Stud Outside Thread is 3/4-16 Pistons
- ⊗ Exception to Standard Stud/Air Inlet Stud Inside Thread of 1/4 N.P.T.

- ▲ No Alignment Specified-Center Stud Mounting is Standard
- ⊗ Threaded Hole 3/8-16 Blind Nut on Bead Plates 1/2-13 Pistons

BELLOWS 1T14C3	AON W01-358-5434	C01-358-2185 7.43 Aluminum
<p>CROSS SECTION</p>	3148 <p>BEAD PLATE TOP</p>	9708/NBD-8626 <p>PISTON BOTTOM</p> <p>Order No. WC1-358-0600</p> <p>APPLICATIONS: Granning 7765</p>
BELLOWS 1T14C3	AON W01-358-9478	C01-358-2185 6.78 Composite
<p>CROSS SECTION</p>	3140 <p>BEAD PLATE TOP</p>	9493/FIP-100743 <p>PISTON BOTTOM</p> <p>Order No. WC1-358-0754</p> <p>APPLICATIONS: Granning 6250</p>
BELLOWS 1T14C5	AON W01-358-5335	C01-358-2114 8.81 Aluminum
<p>CROSS SECTION</p>	4161 <p>BEAD PLATE TOP</p>	9620/FIP-103587 OR 9778/NAD-18053 <p>PISTON BOTTOM</p> <p>APPLICATIONS: General Coach</p>
BELLOWS 1T14C5	AON W01-358-5336	C01-358-2114 8.50 Aluminum
<p>CROSS SECTION</p>	3148 <p>BEAD PLATE TOP</p>	9778/NAD-18053 <p>PISTON BOTTOM</p> <p>Order No. WC1-358-0686</p> <p>APPLICATIONS: John Deere AH160823</p>
BELLOWS 1T14C5	AON W01-358-5345	C01-358-2114 8.59 Aluminum
<p>CROSS SECTION</p>	3079 <p>BEAD PLATE TOP</p>	9620/FIP-103587 OR 9778/NAD-18053 <p>PISTON BOTTOM</p> <p>APPLICATIONS:</p>

BELLOWS 1T14C5	AON W01-358-5354	C01-358-2114 8.50 Aluminum
<p>CROSS SECTION</p>	<p>3148</p> <p>BEAD PLATE TOP</p>	<p>9651/NBD-11498</p> <p>PISTON BOTTOM</p> <p>Order No. WC1-358-9095</p>
<p>APPLICATIONS: Rowe Truck</p>		

BELLOWS 1T14C5	AON W01-358-8868	C01-358-2114 7.28 Aluminum
<p>CROSS SECTION</p>	<p>3106</p> <p>BEAD PLATE TOP</p>	<p>9651/NBD-11498</p> <p>PISTON BOTTOM</p> <p>Order No. WC1-358-9095</p>
<p>APPLICATIONS: Hendrickson 57965-2 (reuse old bracket) Supersedes Hendrickson 57839 Hendrickson 57920-2 w/bracket Includes Bracket 57966-2 (left) 57967-2 (right)</p>		

BELLOWS 1T14C6	AON W01-358-5439	C01-358-2192 10.33 Aluminum
<p>CROSS SECTION</p>	<p>3148</p> <p>BEAD PLATE TOP</p>	<p>9754/NBD-11689</p> <p>PISTON BOTTOM</p> <p>Order No. WC1-358-1603</p>
<p>APPLICATIONS: Link 1103-0500 Ultradie</p>		

BELLOWS 1T14C6	AON W01-358-5730	C01-358-2192 6.38 Composite
<p>CROSS SECTION</p>	<p>4161</p> <p>BEAD PLATE TOP</p>	<p>9493 / FIP-100743</p> <p>PISTON BOTTOM</p>
<p>APPLICATIONS:</p>		

BELLOWS 1T14C6	AON W01-358-8977	C01-358-2192 10.36 Aluminum
<p>CROSS SECTION</p>	<p>3148</p> <p>BEAD PLATE TOP</p>	<p>9754/NBD-11689</p> <p>PISTON BOTTOM</p> <p>Order No. WC1-358-1603</p>
<p>APPLICATIONS: Granning 5301 General Coach Air Ax (Roelofs)</p>		

HARDWARE KEY

- Bolt or Stud 1/2-13
- ⊗ Air Inlet 1/4 N.P.T.
- ⊗ Combination Stud/Air Inlet Stud Outside Thread is 3/4-16 Pistons
- ⊗ Exception to Standard Stud/Air Inlet Stud Inside Thread of 1/4 N.P.T.

- ▲ No Alignment Specified-Center Stud Mounting is Standard
- ⊗ Threaded Hole 3/8-16 Blind Nut on Bead Plates 1/2-13 Pistons

<p>BELLOWS 1T14C6</p>	<p>AON W01-358-8979</p>	<p>C01-358-2192 10.24 Aluminum</p>
<p>CROSS SECTION</p>	<p>3148 9754/NBD-11689</p> <p>BEAD PLATE TOP</p> <p>PISTON BOTTOM</p> <p>Order No. WC1-358-1603</p>	<p>APPLICATIONS: Granning 5553</p>
<p>BELLOWS 1T14C7</p>	<p>AON W01-358-5426</p>	<p>C01-358-2187 9.13 Aluminum</p>
<p>CROSS SECTION</p>	<p>3148 9778 / NAD-18053</p> <p>BEAD PLATE TOP</p> <p>PISTON BOTTOM</p> <p>ORDER NO. WC1-358-0686</p>	<p>APPLICATIONS: Granning 6117</p>
<p>BELLOWS 1T14C7</p>	<p>AON W01-358-5702</p>	<p>C01-358-2187 10.29 Aluminum</p>
<p>CROSS SECTION</p>	<p>3148 9754 / NBD-11689</p> <p>BEAD PLATE TOP</p> <p>PISTON BOTTOM</p> <p>ORDER NO. WC1-358-1603</p>	<p>APPLICATIONS: Granning 8609</p>
<p>BELLOWS 1T14C7</p>	<p>AON W01-358-5710</p>	<p>C01-358-2187 7.25 Aluminum</p>
<p>CROSS SECTION</p>	<p>3140 6853/FIP-103894 OR 9708/NBD-8626</p> <p>BEAD PLATE TOP</p> <p>PISTON BOTTOM</p> <p>Order No. WC1-358-0600</p>	<p>APPLICATIONS:</p> <p>OBSOLETE: NO LONGER AVAILABLE</p>
<p>BELLOWS 1T14C7</p>	<p>AON W01-358-5712</p>	<p>C01-358-2187 7.14 Aluminum</p>
<p>CROSS SECTION</p>	<p>3079 9708 / NBD-8626</p> <p>BEAD PLATE TOP</p> <p>PISTON BOTTOM</p> <p>ORDER NO. WC1-358-0600</p>	<p>APPLICATIONS: Capacity of Texas</p>

<p>BELLOWS 1T14C8</p> <p>CROSS SECTION</p>	<p>AON W01-358-5429</p> <p>3079 9754/NBD-11689</p> <p>BEAD PLATE TOP</p> <p>PISTON BOTTOM</p> <p>ORDER NO. WC1-358-1603</p>	<p>C01-358-2188 10.59 Aluminum</p> <p>APPLICATIONS: Silent Drive</p>
<p>BELLOWS 1T14CB1</p> <p>CROSS SECTION</p>	<p>AON W01-358-5297</p> <p>4159 9491/FIP-100744</p> <p>BEAD PLATE TOP</p> <p>PISTON BOTTOM</p> <p>Order No. WC1-358-0609</p>	<p>C01-358-0018 5.83 Composite</p> <p>APPLICATIONS: Watson & Chalin AS-0106</p> <p>OBSOLETE: NO LONGER AVAILABLE</p>
<p>BELLOWS 1T14CB1</p> <p>CROSS SECTION</p>	<p>AON W01-358-5298</p> <p>3148 9493 / FIP-100743</p> <p>BEAD PLATE TOP</p> <p>PISTON BOTTOM</p> <p>ORDER NO. WC1-358-0754</p>	<p>C01-358-0018 5.70 Composite</p> <p>APPLICATIONS: Gillig Low Floor front 08-372-09-000N</p>
<p>BELLOWS 1T14CB1</p> <p>CROSS SECTION</p>	<p>AON W01-358-5319</p> <p>3101 9493/FIP-100743</p> <p>BEAD PLATE TOP</p> <p>PISTON BOTTOM</p> <p>Order No. WC1-358-0754</p>	<p>C01-358-0018 6.51 Composite</p> <p>APPLICATIONS: Monaco Coach 8618</p>
<p>BELLOWS 1T14CB1</p> <p>CROSS SECTION</p>	<p>AON W01-358-5379</p> <p>4159 9491/FIP-100744</p> <p>BEAD PLATE TOP</p> <p>PISTON BOTTOM</p> <p>Order No. WC1-358-0609</p>	<p>C01-358-0018 6.29 Composite</p> <p>APPLICATIONS:</p>

HARDWARE KEY

- Bolt or Stud 1/2-13
- ⊗ Air Inlet 1/4 N.P.T.
- ⊗ Combination Stud/Air Inlet Stud Outside Thread is 3/4-16 Pistons
- ⊗ Exception to Standard Stud/Air Inlet Stud Inside Thread of 1/4 N.P.T.

- ▲ No Alignment Specified-Center Stud Mounting is Standard
- ⊗ Threaded Hole 3/8-16 Blind Nut on Bead Plates 1/2-13 Pistons

<p>BELLOWS 1T14CB1</p>	<p>AON W01-358-8992</p>	<p>C01-358-0018 5.79 Composite</p>	
<p>CROSS SECTION</p>	<p>3148</p> <p>BEAD PLATE TOP</p>	<p>9491/FIP-100744</p> <p>PISTON BOTTOM</p> <p>Order No. WC1-358-0609</p>	<p>APPLICATIONS: Ridewell 1003588992C</p>
<p>BELLOWS 1T14CB1</p>	<p>AON W01-358-8997</p>	<p>C01-358-0018 5.80 Composite</p>	
<p>CROSS SECTION</p>	<p>3148</p> <p>BEAD PLATE TOP</p>	<p>9491/FIP-100744</p> <p>PISTON BOTTOM</p> <p>Order No. WC1-358-0609</p>	<p>APPLICATIONS: Holland (Neway) 90557034 90557029 Watson & Chalin (AS-0026) Ridewell 1003588997C Silent Drive</p>
<p>BELLOWS 1T15CCR6</p>	<p>AON W01-358-8184</p>	<p>C01-358-2276 20.28 Steel</p>	
<p>CROSS SECTION</p>	<p>3253</p> <p>BEAD PLATE TOP</p>	<p>9645/NAD-31622</p> <p>PISTON BOTTOM</p>	<p>BRACKET WC1-358-3887</p> <p>APPLICATIONS: Neway 90557290 (RL228, KL230) Neway 90557308 (Same except piston stud length 1.5 W01-358-8182)</p>
<p>BELLOWS 1T15DR5.5</p>	<p>AON W01-358-8525</p>	<p>C01-358-1150 18.07 Steel</p>	
<p>CROSS SECTION</p>	<p>3235</p> <p>BEAD PLATE TOP</p>	<p>9639 / NAD-37120</p> <p>PISTON BOTTOM</p>	<p>APPLICATIONS:</p>
<p>BELLOWS 1T15L1.5</p>	<p>AON W01-358-9422</p>	<p>C01-358-2184 9.65 Composite</p>	
<p>CROSS SECTION</p>	<p>3267</p> <p>BEAD PLATE TOP</p>	<p>9571/NAD-18130</p> <p>PISTON BOTTOM</p> <p>Order No. WC1-358-0646</p>	<p>APPLICATIONS: Kenworth K303-6 Kenworth K303-14 Kenworth K303-15 (Airglide 100) older version with no bracket</p>

<p>BELLOWS 1T15L1.5</p> <p>CROSS SECTION</p>	<p>AON W01-358-9584</p> <p>3347 BEAD PLATE TOP</p> <p>9570 / NAD-18162 PISTON BOTTOM</p> <p>Order No. WC1-358-0647</p>	<p>C01-358-2020 12.07 Composite</p> <p>BRACKET WC1-358-3887</p> <p>APPLICATIONS: Neway 90557250 (replaces W01-675-9613, 90557224-flush fitting)</p>
<p>BELLOWS 1T15L1.5</p> <p>CROSS SECTION</p>	<p>AON W01-358-9616</p> <p>3309 BEAD PLATE TOP</p> <p>9571 / NAD-18130 PISTON BOTTOM</p> <p>ORDER NO. WC1-358-0646</p>	<p>C01-358-2184 11.23 Composite</p> <p>BRACKET WC1-358-3893</p> <p>APPLICATIONS: Kenworth K-303-16 (Airglide 100)</p>
<p>BELLOWS 1T15L2</p> <p>CROSS SECTION</p>	<p>AON W01-358-8897</p> <p>3205 BEAD PLATE TOP</p> <p>9571/NAD-18130 PISTON BOTTOM</p>	<p>C01-358-2182 11.80 Composite</p> <p>APPLICATIONS: Monaco 1804591</p>
<p>BELLOWS 1T15L2</p> <p>CROSS SECTION</p>	<p>AON W01-358-8901</p> <p>3271 BEAD PLATE TOP</p> <p>9549 / NAD-29454 PISTON BOTTOM</p> <p>ORDER NO. WC1-358-1616</p>	<p>C01-358-2182 11.56 Composite</p> <p>APPLICATIONS: Ridewell 1003588901C</p>
<p>BELLOWS 1T15L2</p> <p>CROSS SECTION</p>	<p>AON W01-358-9376</p> <p>3220 BEAD PLATE TOP</p> <p>9571/NAD-18130 PISTON BOTTOM</p> <p>Order No. WC1-358-0646</p>	<p>C01-358-2182 11.84 Composite</p> <p>APPLICATIONS: Monaco Coach 8619 Monaco Coach W01-358-8897 with 3/4" NPT</p>

HARDWARE KEY

- Bolt or Stud 1/2-13
- ⊗ Air Inlet 1/4 N.P.T.
- ⊗ Combination Stud/Air Inlet Stud Outside Thread is 3/4-16 Pistons
- ⊗ Exception to Standard Stud/Air Inlet Stud Inside Thread of 1/4 N.P.T.

- ▲ No Alignment Specified-Center Stud Mounting is Standard
- ⊗ Threaded Hole 3/8-16 Blind Nut on Bead Plates 1/2-13 Pistons

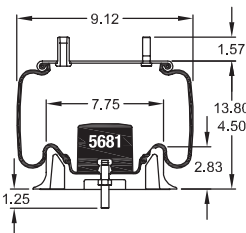
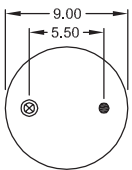
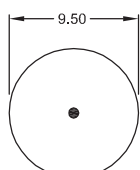
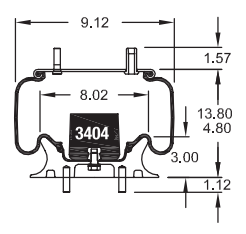
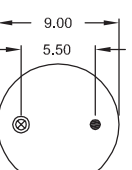
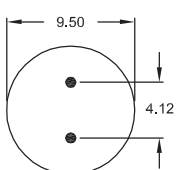
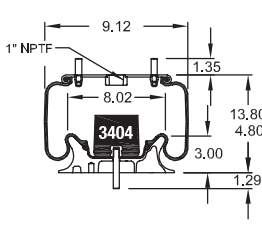
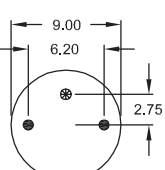
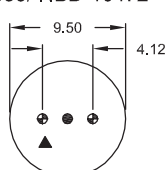
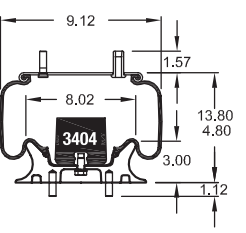
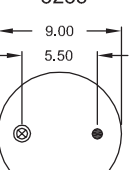
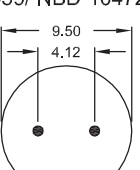
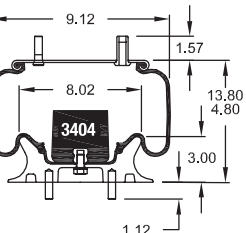
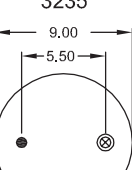
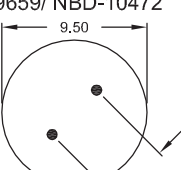
<p>BELLOWS 1T15L2</p>	<p>AON W01-358-9387</p>	<p>C01-358-2182 10.40 Composite</p>
 <p>CROSS SECTION</p>	 <p>3235 BEAD PLATE TOP</p>	 <p>9573/NAD-18162 PISTON BOTTOM</p> <p>APPLICATIONS: Ridewell 1003589387C</p>
<p>BELLOWS 1T15L2</p>	<p>AON W01-358-9445</p>	<p>C01-358-2182 14.26 Aluminum</p>
 <p>CROSS SECTION</p>	 <p>3235 BEAD PLATE TOP</p>	 <p>9659/NBD-10472 PISTON BOTTOM</p> <p>ORDER NO. WC1-358-0683</p> <p>APPLICATIONS: Ridewell 1003589445C REPLACEMENT PISTON COMES WITHOUT STUDS</p>
<p>BELLOWS 1T15L2</p>	<p>AON W01-358-9447</p>	<p>C01-358-2182 14.06 Aluminum</p>
 <p>CROSS SECTION</p>	 <p>3241 BEAD PLATE TOP</p>	 <p>9659/NBD-10472 PISTON BOTTOM</p> <p>ORDER NO. WC1-358-0683</p> <p>APPLICATIONS: Ridewell 1003589447C</p>
<p>BELLOWS 1T15L2</p>	<p>AON W01-358-9448</p>	<p>C01-358-2182 19.98 Aluminum</p>
 <p>CROSS SECTION</p>	 <p>3235 BEAD PLATE TOP</p>	 <p>9659/NBD-10472 PISTON BOTTOM</p> <p>ORDER NO. WC1-358-0683</p> <p>APPLICATIONS: Ridewell 1003589448C Foretravel Inc. REPLACEMENT PISTON COMES WITHOUT STUDS</p>
<p>BELLOWS 1T15L2</p>	<p>AON W01-358-9457</p>	<p>C01-358-2182 14.00 Aluminum</p>
 <p>CROSS SECTION</p>	 <p>3235 BEAD PLATE TOP</p>	 <p>9659/NBD-10472 PISTON BOTTOM</p> <p>ORDER NO. WC1-358-0683</p> <p>APPLICATIONS: Ridewell 1003589457C REPLACEMENT PISTON COMES WITHOUT STUDS</p>

BELLOWS 1T15L2	AON W01-358-9459	C01-358-2182 13.88 Aluminum
<p>CROSS SECTION</p>	<p>BEAD PLATE TOP</p>	<p>PISTON BOTTOM</p>
ORDER NO. WC1-358-0683		<p>APPLICATIONS: Ridewell 1003589459C ArvinMeritor A-2258-U-1451 RFA23ER-RV</p>

BELLOWS 1T15L2	AON W01-358-9477	C01-358-2182 13.72 Aluminum
<p>CROSS SECTION</p>	<p>BEAD PLATE TOP</p>	<p>PISTON BOTTOM</p>
ORDER NO. WC1-358-0683		<p>APPLICATIONS: Ridewell 1003589477C</p>

BELLOWS 1T15L2	AON W01-358-9551	C01-358-2182 10.56 Composite
<p>CROSS SECTION</p>	<p>BEAD PLATE TOP</p>	<p>PISTON BOTTOM</p>
Order No. WC1-358-0646		<p>APPLICATIONS: Roadmaster</p> <p>OBSELETE: NO LONGER AVAILABLE</p>

BELLOWS 1T15L2	AON W01-358-9562	C01-358-2182 11.64 Composite
<p>CROSS SECTION</p>	<p>BEAD PLATE TOP</p>	<p>PISTON BOTTOM</p>
ORDER NO. WC1-358-0683		<p>APPLICATIONS: Link 1103-0501 Liftable</p>

BELLOWS 1T15L4	AON W01-358-8647	C01-358-2176 11.31 Composite
<p>CROSS SECTION</p>	<p>BEAD PLATE TOP</p>	<p>PISTON BOTTOM</p>
ORDER NO. WC1-358-1616		<p>APPLICATIONS:</p>

HARDWARE KEY

- Bolt or Stud 1/2-13
- ⊗ Air Inlet 1/4 N.P.T.
- ⊙ Combination Stud/Air Inlet Stud Outside Thread is 3/4-16 Pistons
- ⊕ Exception to Standard Stud/Air Inlet Stud Inside Thread of 1/4 N.P.T.
- ▲ No Alignment Specified-Center Stud Mounting is Standard
- ⊖ Threaded Hole 3/8-16 Blind Nut on Bead Plates 1/2-13 Pistons

BELLOWS 1T15L4	AON W01-358-8874	C01-358-2176 11.36 Composite
<p>CROSS SECTION</p>	<p>3271 BEAD PLATE TOP</p> <p>9549/ NAD-29454 PISTON BOTTOM</p> <p>ORDER NO. WC1-358-1616</p>	APPLICATIONS:
BELLOWS 1T15L4	AON W01-358-8916	C01-358-2176 15.51 Aluminum
<p>CROSS SECTION</p>	<p>3313 BEAD PLATE TOP</p> <p>9659/NBD-10472 OR 6778/FIP-103969 PISTON BOTTOM</p>	APPLICATIONS:
BELLOWS 1T15L4	AON W01-358-8919	C01-358-2176 12.95 Composite
<p>CROSS SECTION</p>	<p>3271 BEAD PLATE TOP</p> <p>9549/ NAD-29454 PISTON BOTTOM</p> <p>ORDER NO. WC1-358-1616</p>	APPLICATIONS: Ridewell 1003588919C
BELLOWS 1T15L4	AON W01-358-8922	C01-358-2176 13.64 Aluminum
<p>CROSS SECTION</p>	<p>3235 BEAD PLATE TOP</p> <p>9659/ NBD-10472 PISTON BOTTOM</p> <p>ORDER NO. WC1-358-0683</p>	APPLICATIONS: Granning 5492 Granning 5385 (no stud)
BELLOWS 1T15L4	AON W01-358-8941	C01-358-2176 13.50 Aluminum
<p>CROSS SECTION</p>	<p>3004 BEAD PLATE TOP</p> <p>9659/NBD-10472 PISTON BOTTOM</p> <p>Order No. WC1-358-0683</p>	APPLICATIONS: Hendrickson 59031-2

BELLOWS 1T15L4	AON W01-358-9391	C01-358-2176 13.32 Aluminum	
<p>CROSS SECTION</p>	<p>3220</p> <p>BEAD PLATE TOP</p>	<p>3822 / NBD-10378</p> <p>PISTON BOTTOM</p>	<p>APPLICATIONS:</p>

BELLOWS 1T15L4	AON W01-358-9415	C01-358-2176 15.70 Aluminum	
<p>CROSS SECTION</p>	<p>3264</p> <p>BEAD PLATE TOP</p>	<p>9691/ NBD-14503</p> <p>ORDER NO. WC1-358-0606</p> <p>PISTON BOTTOM</p>	<p>APPLICATIONS: Kenworth K-303-5 REPLACEMENT PISTON COMES WITHOUT STUDS</p>

BELLOWS 1T15L4	AON W01-358-9439	C01-358-2176 14.50 Aluminum	
<p>CROSS SECTION</p>	<p>3271</p> <p>BEAD PLATE TOP</p>	<p>9656 / NBD-10440</p> <p>ORDER NO. WC1-358-0652</p> <p>PISTON BOTTOM</p>	<p>APPLICATIONS: Waggoner's Truck Hagie Mfg.</p>

BELLOWS 1T15L4	AON W01-358-9441	C01-358-2176 15.10 Aluminum	
<p>CROSS SECTION</p>	<p>3271</p> <p>BEAD PLATE TOP</p>	<p>9606 / NAD-35550</p> <p>ORDER NO. WC1-358-0652</p> <p>PISTON BOTTOM</p>	<p>APPLICATIONS:</p>

BELLOWS 1T15L4	AON W01-358-9469	C01-358-2176 14.71 Composite	
<p>CROSS SECTION</p>	<p>3271</p> <p>BEAD PLATE TOP</p>	<p>9490 / FIP-101012</p> <p>PISTON BOTTOM</p>	<p>APPLICATIONS:</p>

- HARDWARE KEY**
- Bolt or Stud 1/2-13
 - ⊗ Air Inlet 1/4 N.P.T.
 - ⊗ Combination Stud/Air Inlet Stud Outside Thread is 3/4-16 Pistons
 - ⊗ Exception to Standard Stud/Air Inlet Stud Inside Thread of 1/4 N.P.T.

- ▲ No Alignment Specified-Center Stud Mounting is Standard
- ⊗ Threaded Hole 3/8-16 Blind Nut on Bead Plates 1/2-13 Pistons

BELLOWS 1T15L6	AON W01-358-9626	C01-358-1039 13.36 Composite
<p>CROSS SECTION</p>	3306 <p>BEAD PLATE TOP</p> 9532/ NAD-29827 <p>PISTON BOTTOM</p> ORDER NO. WC1-358-1619	APPLICATIONS: Hendrickson Trailer S23720
BELLOWS 1T15L6	AON W01-358-9749	C01-358-2211 24.43 Composite
<p>CROSS SECTION</p>	3190 <p>BEAD PLATE TOP</p> 9585/FIP-101543 <p>PISTON BOTTOM</p>	APPLICATIONS:
BELLOWS 1T15L9	AON W01-358-9560	C01-358-2171 14.08 Composite
<p>CROSS SECTION</p>	3242 <p>BEAD PLATE TOP</p> 9530/ NAD-27809 <p>PISTON BOTTOM</p> ORDER NO. WC1-358-9452	APPLICATIONS: Reyco 25396-01
BELLOWS 1T15LA(-1)	AON W01-358-9547	C01-358-2003 11.00 Composite
<p>CROSS SECTION</p>	3509 <p>BEAD PLATE TOP</p> 9569/NAD-27754 <p>PISTON BOTTOM</p> Order No. WC1-358-1629	BRACKET WC1-358-3883 APPLICATIONS: Kenworth C81-1004 Airglide 200 5/5/03 or later Airglide 400
BELLOWS 1T15LA(-1)	AON W01-358-9617	C01-358-2003 11.18 Composite
<p>CROSS SECTION</p>	3174 <p>BEAD PLATE TOP</p> 9569/NAD-27754 <p>PISTON BOTTOM</p> Order No. WC1-358-1629	BRACKET WC1-358-3892 APPLICATIONS: Kenworth K-303-18 (Airglide 200) - small air fitting - original design (1996 & 1997 prod.) Replaced by K -303-22(9622)

<p>BELLOWS 1T15LA(-1)</p> <p>CROSS SECTION BEAD PLATE TOP PISTON BOTTOM</p>	<p>AON W01-358-9622</p> <p>C01-358-2003 11.19 Composite</p> <p>BRACKET WC1-358-3883</p> <p>APPLICATIONS: Kenworth K-303-22 (Airglide 200-1998 to 5/5/03) - (large air fitting with interconnected airsprings)</p>
<p>BELLOWS 1T15LA0</p> <p>CROSS SECTION BEAD PLATE TOP PISTON BOTTOM</p>	<p>AON W01-358-9541</p> <p>C01-358-2021 11.00 Composite</p> <p>BRACKET WC1-358-3890</p> <p>APPLICATIONS: Kenworth C81-1005 Airglide 200 5/5/03 or later Airglide 460 Airglide 690</p>
<p>BELLOWS 1T15LA0</p> <p>CROSS SECTION BEAD PLATE TOP PISTON BOTTOM</p>	<p>AON W01-358-9618</p> <p>C01-358-2007 13.52 Composite</p> <p>BRACKET WC1-358-3892</p> <p>APPLICATIONS: Kenworth K-303-19 (Airglide 200-46,000#) - small air fitting -1996 & 97 prod. Replaced by K-303-25(9625)</p>
<p>BELLOWS 1T15LA0</p> <p>CROSS SECTION BEAD PLATE TOP PISTON BOTTOM</p>	<p>AON W01-358-9625</p> <p>C01-358-2007 13.48 Composite</p> <p>BRACKET WC1-358-3890</p> <p>APPLICATIONS: Kenworth K-303-25 (Airglide 200-46,000#, 1998 & later prod.)</p>
<p>BELLOWS 1T15LA0</p> <p>CROSS SECTION BEAD PLATE TOP PISTON BOTTOM</p>	<p>AON W01-358-9675</p> <p>C01-358-2021 11.63 Composite</p> <p>BRACKET WC1-358-3890</p> <p>APPLICATIONS: Kenworth K-303-28 Airglide 200 Before 5/5/03</p>

HARDWARE KEY

- Bolt or Stud 1/2-13
- ⊗ Air Inlet 1/4 N.P.T.
- ⊗ Combination Stud/Air Inlet Stud Outside Thread is 3/4-16 Pistons
- ⊗ Exception to Standard Stud/Air Inlet Stud Inside Thread of 1/4 N.P.T.

- ▲ No Alignment Specified-Center Stud Mounting is Standard
- ⊗ Threaded Hole 3/8-16 Blind Nut on Bead Plates 1/2-13 Pistons

BELLOWS 1T15LB10	AON W01-358-9621	C01-358-2018 14.53 Composite
<p>CROSS SECTION</p>	<p>BEAD PLATE TOP</p>	<p>PISTON BOTTOM</p> <p>ORDER NO. WC1-358-1619</p> <p>APPLICATIONS: Hendrickson Trailer S23613</p>
BELLOWS 1T15LC2.5	AON W01-358-9379	C01-358-2179 13.63 Aluminum
<p>CROSS SECTION</p>	<p>BEAD PLATE TOP</p>	<p>PISTON BOTTOM</p> <p>APPLICATIONS: Navistar (U-Haul) 1660694C-1</p>
BELLOWS 1T15LC2.5	AON W01-358-9565	C01-358-2179 11.81 Aluminum
<p>CROSS SECTION</p>	<p>BEAD PLATE TOP</p>	<p>PISTON BOTTOM</p> <p>APPLICATIONS: Navistar 2027912C1 (GY 1R12-324)</p>
BELLOWS 1T15LC2.5	AON W01-358-9566	C01-358-2179 11.81 Aluminum
<p>CROSS SECTION</p>	<p>BEAD PLATE TOP</p>	<p>PISTON BOTTOM</p> <p>APPLICATIONS: Navistar 1672401C1 (GY 1R12-204)</p> <p>OBSELETE: NO LONGER AVAILABLE</p>
BELLOWS 1T15LC4.5	AON W01-358-9567	C01-358-2166 14.12 Aluminum
<p>CROSS SECTION</p>	<p>BEAD PLATE TOP</p>	<p>PISTON BOTTOM</p> <p>APPLICATIONS: Navistar 2027913C1 (GY 1R12-325)</p> <p>OBSELETE: NO LONGER AVAILABLE</p>

<p>BELLOWS 1T15LC4.5</p> <p>CROSS SECTION</p>	<p>AON W01-358-9568</p> <p>BEAD PLATE TOP</p> <p>PISTON BOTTOM</p>	<p>C01-358-2166 14.54 Aluminum</p> <p>APPLICATIONS: Navistar 1675495C1 (GY 1R12-205)</p>
<p>BELLOWS 1T15LC12</p> <p>CROSS SECTION</p>	<p>AON W01-358-9619</p> <p>BEAD PLATE TOP</p> <p>PISTON BOTTOM</p> <p>ORDER NO. WC1-358-0664</p>	<p>C01-358-2170 16.15 Composite</p> <p>APPLICATIONS: Hendrickson Trailer S23614</p>
<p>BELLOWS 1T15LP1.5</p> <p>CROSS SECTION</p>	<p>AON W01-358-8597</p> <p>BEAD PLATE TOP</p> <p>PISTON BOTTOM</p> <p>Order No. WC1-358-0683</p>	<p>C01-358-0106 14.61 Aluminum</p> <p>APPLICATIONS: Hendrickson Truck 65790-2</p>
<p>BELLOWS 1T15LP2</p> <p>CROSS SECTION</p>	<p>AON W01-358-8959</p> <p>BEAD PLATE TOP</p> <p>PISTON BOTTOM</p> <p>ORDER NO. WC1-358-1616</p>	<p>C01-358-0107 14.58 Composite</p> <p>APPLICATIONS: Reyco 20773-01</p>
<p>BELLOWS 1T15LP2</p> <p>CROSS SECTION</p>	<p>AON W01-358-9554</p> <p>BEAD PLATE TOP</p> <p>PISTON BOTTOM</p> <p>ORDER NO. WC1-358-1629</p>	<p>C01-M58-2212 10.96 Composite</p> <p>APPLICATIONS: Hendrickson 60716-2 Volvo 20462941</p>

HARDWARE KEY

- Bolt or Stud 1/2-13
- ⊗ Air Inlet 1/4 N.P.T.
- ⊙ Combination Stud/Air Inlet Stud Outside Thread is 3/4-16 Pistons
- ⊕ Exception to Standard Stud/Air Inlet Stud Inside Thread of 1/4 N.P.T.

- ▲ No Alignment Specified-Center Stud Mounting is Standard
- ⊕ Threaded Hole 3/8-16 Blind Nut on Bead Plates 1/2-13 Pistons

<p>BELLOWS 1T15LP3</p>	<p>AON W01-358-8478</p>	<p>C01-358-0093 13.00 Aluminum</p>
<p>CROSS SECTION</p>	<p>3201</p> <p>BEAD PLATE TOP</p>	<p>9567 / NAD-35451</p> <p>PISTON BOTTOM</p> <p>APPLICATIONS:</p> <p>REPLACES W01-358-9259</p>
<p>BELLOWS 1T15LP3</p>	<p>AON W01-358-8492</p>	<p>C01-358-0093 13.65 Composite</p>
<p>CROSS SECTION</p>	<p>3271</p> <p>BEAD PLATE TOP</p>	<p>9549/ NAD-29454</p> <p>PISTON BOTTOM</p> <p>ORDER NO. WC1-358-1616</p> <p>APPLICATIONS:</p>
<p>BELLOWS 1T15LP3</p>	<p>AON W01-358-9017</p>	<p>C01-358-0093 11.68 Composite</p>
<p>CROSS SECTION</p>	<p>3190</p> <p>BEAD PLATE TOP</p>	<p>9566 / NAD-35451</p> <p>PISTON BOTTOM</p> <p>APPLICATIONS:</p>
<p>BELLOWS 1T15LP3</p>	<p>AON W01-358-9049</p>	<p>C01-358-0093 13.64 Composite</p>
<p>CROSS SECTION</p>	<p>3215</p> <p>BEAD PLATE TOP</p>	<p>9565/NAD-35451</p> <p>PISTON BOTTOM</p> <p>APPLICATIONS: East Mfg. Granning 6252</p> <p>REPLACES 1T15S6</p>
<p>BELLOWS 1T15LP3</p>	<p>AON W01-358-9073</p>	<p>C01-358-0093 15.86 Composite</p>
<p>CROSS SECTION</p>	<p>3264</p> <p>BEAD PLATE TOP</p>	<p>9566/NAD-35451</p> <p>PISTON BOTTOM</p> <p>Order No. N/A</p> <p>APPLICATIONS: Circle R Kenworth K-102-A Hendrickson Trailer S-7193 Ridewell 1003589073C</p>

BELLOWS 1T15LP3	AON W01-358-9285	C01-358-0093	11.63 Composite
<p>CROSS SECTION</p>	<p>3271 BEAD PLATE TOP</p>	<p>9565 / NAD-35451 PISTON BOTTOM</p>	<p>APPLICATIONS: Hendrickson Trailer S-7364 REPLACEMENT PISTON COMES WITHOUT STUDS</p> <p>OBSOLETE: NO LONGER AVAILABLE</p>

BELLOWS 1T15LP3	AON W01-358-9290	C01-358-0093	14.14 Composite
<p>CROSS SECTION</p>	<p>3235 BEAD PLATE TOP</p>	<p>9566/NAD-35451 PISTON BOTTOM</p> <p>Order No. WC1-358-1659</p>	<p>APPLICATIONS: American Carrier 8003-025 (supersedes 9234) Ridewell 1003589290C Peerless</p>

BELLOWS 1T15LP3	AON W01-358-9539	C01-358-0093	17.13 Composite
<p>CROSS SECTION</p>	<p>3271 BEAD PLATE TOP</p>	<p>9566 / NAD-35451 PISTON BOTTOM</p>	<p>APPLICATIONS:</p>

BELLOWS 1T15LP3	AON W01-358-9587	C01-358-0093	14.67 Aluminum
<p>CROSS SECTION</p>	<p>3347 BEAD PLATE TOP</p>	<p>9567/NAD-35451 PISTON BOTTOM</p>	<p>BRACKET WC1-358-3887</p> <p>APPLICATIONS: Holland (Neway) 90557248 (replaces 90557220-1/2" NPT flush) - ref. W01-358-9597</p>

BELLOWS 1T15LP3	AON W01-358-9592	C01-358-0093	14.51 Composite
<p>CROSS SECTION</p>	<p>3190 BEAD PLATE TOP</p>	<p>9566/NAD-35451 PISTON BOTTOM</p> <p>Order No. WC1-358-1659</p>	<p>APPLICATIONS:</p>

HARDWARE KEY

- Bolt or Stud 1/2-13
- ⊗ Air Inlet 1/4 N.P.T.
- ⊗ Combination Stud/Air Inlet Stud Outside Thread is 3/4-16 Pistons
- ⊗ Exception to Standard Stud/Air Inlet Stud Inside Thread of 1/4 N.P.T.

- ▲ No Alignment Specified-Center Stud Mounting is Standard
- ⊗ Threaded Hole 3/8-16 Blind Nut on Bead Plates 1/2-13 Pistons

<p>BELLOWS 1T15LP3</p>	<p>AON W01-358-9595</p>	<p>C01-358-0093 14.14 Composite</p>
<p>CROSS SECTION</p>	<p>3235 9.00 5.50</p> <p>BEAD PLATE TOP</p> <p>9566 / NAD-35451 9.45 4.12</p> <p>PISTON BOTTOM</p>	<p>APPLICATIONS:</p>
<p>BELLOWS 1T15LP3</p>	<p>AON W01-358-9597</p>	<p>C01-358-0093 14.69 Aluminum</p>
<p>CROSS SECTION</p>	<p>3253 5.87 4.37 3.00 2.44</p> <p>BEAD PLATE TOP</p> <p>9567/NAD-35451 9.45</p> <p>PISTON BOTTOM</p>	<p>BRACKET WC1-358-3887</p> <p>APPLICATIONS: Holland (Neway) 90557172 (AD-200) - ref. 90557220 90557248 (1/2" NPT)</p>
<p>BELLOWS 1T15LP3</p>	<p>AON W01-358-9599</p>	<p>C01-358-0093 13.96 Aluminum</p>
<p>CROSS SECTION</p>	<p>3235 9.00 5.50</p> <p>BEAD PLATE TOP</p> <p>9567/NAD-35451 9.45</p> <p>PISTON BOTTOM</p>	<p>APPLICATIONS: Holland (Neway) 90557094 (ARD suspensions) - reference 90557128 (bead plate-3215) Holland (Neway) 90557128</p>
<p>BELLOWS 1T15LP3</p>	<p>AON W01-358-9652</p>	<p>C01-358-0093 11.38 Composite</p>
<p>CROSS SECTION</p>	<p>3190 9.00 4.75</p> <p>BEAD PLATE TOP</p> <p>9565/NAD-35451 9.45 4.12</p> <p>PISTON BOTTOM</p> <p>Order No. WC1-358-1658</p>	<p>APPLICATIONS: Mack 57QL1115 Hendrickson Trailer S14147 Supersedes W01-358-9043</p>
<p>BELLOWS 1T15LP3</p>	<p>AON W01-358-9750</p>	<p>C01-358-0093 10.43 Composite</p>
<p>CROSS SECTION</p>	<p>3202 9.00 6.20 2.88</p> <p>BEAD PLATE TOP</p> <p>9572/ NAD-18161 9.50 4.12</p> <p>PISTON BOTTOM</p>	<p>APPLICATIONS:</p>

<p>BELLOWS 1T15LP3</p>	<p>AON W01-358-9953</p>	<p>C01-358-0093 17.93 Aluminum</p>
<p>CROSS SECTION</p>	<p>BEAD PLATE TOP</p>	<p>PISTON BOTTOM</p> <p>APPLICATIONS: Air AX (Roelofs)</p>
<p>BELLOWS 1T15LP5</p>	<p>AON W01-358-8949</p>	<p>C01-358-0095 12.82 Composite</p>
<p>CROSS SECTION</p>	<p>BEAD PLATE TOP</p>	<p>PISTON BOTTOM</p> <p>ORDER NO. WC1-358-1616</p> <p>APPLICATIONS: Holland (Neway) 90557150</p>
<p>BELLOWS 1T15LP5</p>	<p>AON W01-358-9291</p>	<p>C01-358-0095 14.66 Composite</p>
<p>CROSS SECTION</p>	<p>BEAD PLATE TOP</p>	<p>PISTON BOTTOM</p> <p>ORDER NO. WC1-358-0664</p> <p>APPLICATIONS: Holland (Neway) 90557139 (RL196-17) (RL196A-17) - replaces 90557122 - originally 1T15M-4 bellows</p>
<p>BELLOWS 1T15LP5</p>	<p>AON W01-358-9293</p>	<p>C01-358-0095 13.26 Composite</p>
<p>CROSS SECTION</p>	<p>BEAD PLATE TOP</p>	<p>PISTON BOTTOM</p> <p>Order No. WC1-358-0666</p> <p>APPLICATIONS: Holland (Neway) 90557120 (RL196-14, RL196A-14)</p>
<p>BELLOWS 1T15LP5</p>	<p>AON W01-358-9294</p>	<p>C01-358-0095 11.38 Composite</p>
<p>CROSS SECTION</p>	<p>BEAD PLATE TOP</p>	<p>PISTON BOTTOM</p> <p>ORDER NO. WC1-358-1634</p> <p>APPLICATIONS: Holland (Neway) 90557127 (RL196-12)</p>

HARDWARE KEY

- Bolt or Stud 1/2-13
- ⊗ Air Inlet 1/4 N.P.T.
- ⊙ Combination Stud/Air Inlet Stud Outside Thread is 3/4-16 Pistons
- ⊕ Exception to Standard Stud/Air Inlet Stud Inside Thread of 1/4 N.P.T.

- ▲ No Alignment Specified-Center Stud Mounting is Standard
- ⊕ Threaded Hole 3/8-16 Blind Nut on Bead Plates 1/2-13 Pistons

BELLOWS 1T15LP5	AON W01-358-9295	<p>CROSS SECTION</p>	<p>3235</p> <p>BEAD PLATE TOP</p>	<p>9532/ NAD-29827</p> <p>PISTON BOTTOM</p> <p>ORDER NO. WC1-358-1619</p>	<p>C01-358-0095 13.16 Composite</p> <hr/> <p>APPLICATIONS: Holland (Neway) 90557121 (RL196-15 & 16) (RL196A-15 & 16)</p>
------------------------	-------------------------	----------------------	-----------------------------------	---	---

BELLOWS 1T15M0	AON W01-358-8961	<p>CROSS SECTION</p>	<p>3003</p> <p>BEAD PLATE TOP</p>	<p>9572/ NAD-18161</p> <p>PISTON BOTTOM</p>	<p>C01-358-2139 10.08 Composite</p> <hr/> <p>APPLICATIONS: Reyco 23377-01</p>
-----------------------	-------------------------	----------------------	-----------------------------------	---	--

BELLOWS 1T15M0	AON W01-358-8963	<p>CROSS SECTION</p>	<p>3188</p> <p>BEAD PLATE TOP</p>	<p>9655/ NBD-10439</p> <p>PISTON BOTTOM</p> <p>ORDER NO. WC1-358-9454</p>	<p>C01-358-2151 13.17 Aluminum</p> <hr/> <p>APPLICATIONS: Ridewell 1003588963C</p> <p>OBSELETE: NO LONGER AVAILABLE</p>
-----------------------	-------------------------	----------------------	-----------------------------------	---	---

BELLOWS 1T15M0	AON W01-358-8964	<p>CROSS SECTION</p>	<p>3210</p> <p>BEAD PLATE TOP</p>	<p>9571/ NAD-18130</p> <p>PISTON BOTTOM</p> <p>ORDER NO. WC1-358-0646</p>	<p>C01-358-2139 11.64 Composite</p> <hr/> <p>APPLICATIONS: Reyco 21598-01</p>
-----------------------	-------------------------	----------------------	-----------------------------------	---	--

BELLOWS 1T15M0	AON W01-358-8971	<p>CROSS SECTION</p>	<p>3271</p> <p>BEAD PLATE TOP</p>	<p>9573/ NAD-18162</p> <p>PISTON BOTTOM</p> <p>ORDER NO. WC1-358-1634</p>	<p>C01-358-2139 10.13 Composite</p> <hr/> <p>APPLICATIONS: Hendrickson 59484-2 (Blue Bird)</p>
-----------------------	-------------------------	----------------------	-----------------------------------	---	---

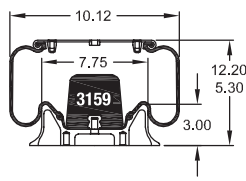
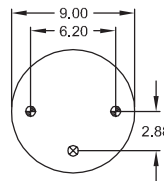
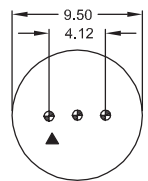
BELLOWS 1T15M0	AON W01-358-9031	C01-358-2139 🔒 12.96 🏭 Aluminum
 <p>CROSS SECTION</p>	<p>3215</p>  <p>BEAD PLATE TOP</p>	<p>9654/ NBD-10438</p>  <p>PISTON BOTTOM</p> <p>ORDER NO. WC1-358-0663</p>
<p>APPLICATIONS: Peerless 0550-00051</p>		

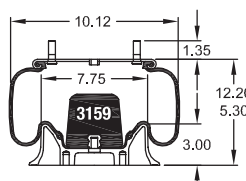
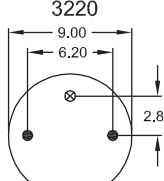
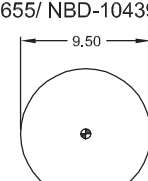
BELLOWS 1T15M0	AON W01-358-9033	C01-358-2139 🔒 13.36 🏭 Aluminum
 <p>CROSS SECTION</p>	<p>3220</p>  <p>BEAD PLATE TOP</p>	<p>9655/ NBD-10439</p>  <p>PISTON BOTTOM</p> <p>ORDER NO. WC1-358-9454</p>
<p>APPLICATIONS: Holland (Neway) 90557012 Mfg.SV.# Holland (Neway) 90044198</p>		

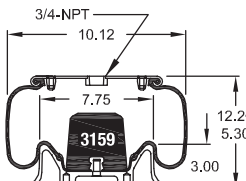
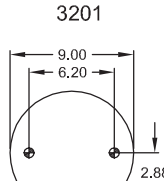
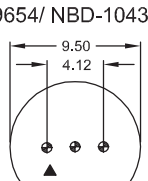
BELLOWS 1T15M0	AON W01-358-9036	C01-358-2139 🔒 13.40 🏭 Aluminum
 <p>CROSS SECTION</p>	<p>3201</p>  <p>BEAD PLATE TOP</p>	<p>9654/ NBD-10438</p>  <p>PISTON BOTTOM</p> <p>ORDER NO. WC1-358-0663</p>
<p>APPLICATIONS: Willmar</p>		

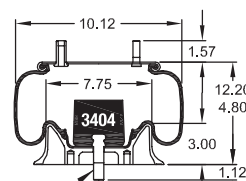
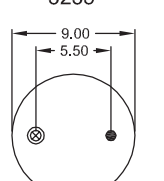
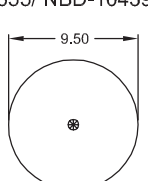
BELLOWS 1T15M0	AON W01-358-9039	C01-358-2151 🔒 13.44 🏭 Aluminum
 <p>CROSS SECTION</p>	<p>3235</p>  <p>BEAD PLATE TOP</p>	<p>9655/ NBD-10439</p>  <p>PISTON BOTTOM</p> <p>ORDER NO. WC1-358-9454</p>
<p>SEVICE ASSEMBLY W01-358-0702</p> <p>APPLICATIONS: Hendrickson Trailer S2064/S11650 Holland (Neway) 90557001, 90557023, 90557085 Hutchens H-9424-01 R & S Truck & Body 1090218 Ridewell 1013589039C FabTek 101827 Sauer P50-734 Watson & Chalin AS-0012</p>		

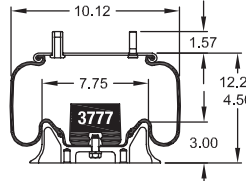
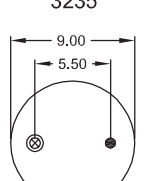
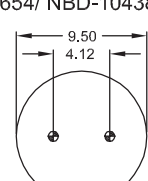
BELLOWS 1T15M0	AON W01-358-9308	C01-358-2139 🔒 13.03 🏭 Aluminum
 <p>CROSS SECTION</p>	<p>3235</p>  <p>BEAD PLATE TOP</p>	<p>9654/ NBD-10438</p>  <p>PISTON BOTTOM</p> <p>ORDER NO. WC1-358-0663</p>
<p>APPLICATIONS: Reyco 17360-01 Holland (Neway) 90557089 (remove bolt)</p>		

HARDWARE KEY

- Bolt or Stud 1/2-13
- ⊗ Air Inlet 1/4 N.P.T.
- ⊗ Combination Stud/Air Inlet Stud Outside Thread is 3/4-16 Pistons
- ⊗ Exception to Standard Stud/Air Inlet Stud Inside Thread of 1/4 N.P.T.

- ▲ No Alignment Specified-Center Stud Mounting is Standard
- ⊗ Threaded Hole 3/8-16 Blind Nut on Bead Plates 1/2-13 Pistons

BELLOWS 1T15M0	AON W01-358-9333	C01-358-2139	12.75	Aluminum
<p>CROSS SECTION</p>	<p>3210</p> <p>BEAD PLATE TOP</p>	<p>9654/ NBD-10438</p> <p>PISTON BOTTOM</p>	<p>APPLICATIONS: Reyco 20437-01</p> <p>OBSOLETE: NO LONGER AVAILABLE</p>	
ORDER NO. WC1-358-0663				

BELLOWS 1T15M0	AON W01-358-9334	C01-358-2139	12.97	Aluminum
<p>CROSS SECTION</p>	<p>3235</p> <p>BEAD PLATE TOP</p>	<p>9654/ NBD-10438</p> <p>PISTON BOTTOM</p>	<p>APPLICATIONS: Ridewell 1003589334C</p>	
ORDER NO. WC1-358-0663				

BELLOWS 1T15M0.5	AON W01-358-8970	C01-358-2193	10.59	Composite
<p>CROSS SECTION</p>	<p>3235</p> <p>BEAD PLATE TOP</p>	<p>9570/NAD-18162</p> <p>PISTON BOTTOM</p>	<p>APPLICATIONS:</p>	

BELLOWS 1T15M0.5	AON W01-358-9306	C01-358-2193	11.34	Composite
<p>CROSS SECTION</p>	<p>3235</p> <p>BEAD PLATE TOP</p>	<p>9570/NAD-18162</p> <p>PISTON BOTTOM</p>	<p>APPLICATIONS:</p>	

BELLOWS 1T15M0.5	AON W01-358-9307	C01-358-2190	10.14	Composite
<p>CROSS SECTION</p>	<p>3235</p> <p>BEAD PLATE TOP</p>	<p>9573/NAD-18162</p> <p>PISTON BOTTOM</p>	<p>APPLICATIONS: Holland (Neway) 90557129 (AR-41, 45 & 45-1) (plastic)</p>	
ORDER NO. WC1-358-1634				

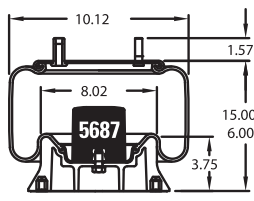
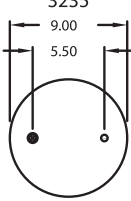
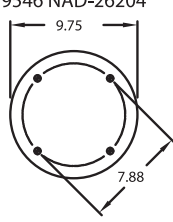
BELLOWS 1T15M2	AON W01-358-8195	 <p>CROSS SECTION</p>	 <p>BEAD PLATE TOP</p>	 <p>PISTON BOTTOM</p>	<p>C01-358-1131 12.64 Composite</p> <hr/> <p>APPLICATIONS:</p>
-----------------------	-------------------------	--	---	--	--

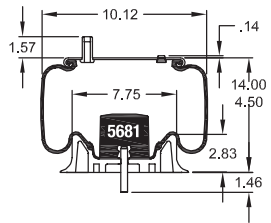
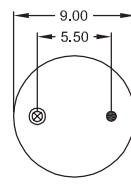
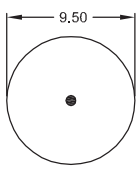
BELLOWS 1T15M2	AON W01-358-8197	 <p>CROSS SECTION</p>	 <p>BEAD PLATE TOP</p>	 <p>PISTON BOTTOM</p> <p>ORDER NO. WC1-358-1634</p>	<p>C01-358-1131 10.37 Composite</p> <hr/> <p>APPLICATIONS: Holland (Neway) 90557230</p>
-----------------------	-------------------------	--	---	--	---

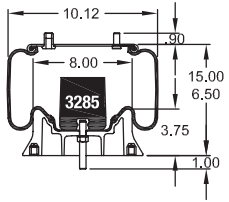
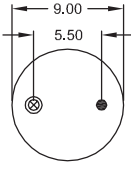
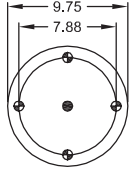
BELLOWS 1T15M2	AON W01-358-8198	 <p>CROSS SECTION</p>	 <p>BEAD PLATE TOP</p>	 <p>PISTON BOTTOM</p> <p>ORDER NO. WC1-358-1652</p>	<p>C01-358-1131 13.27 Composite</p> <hr/> <p>APPLICATIONS: 90557229 (IFS-114) - (center stud used for locating in pre-assembly)</p> <p>OBSELETE: NO LONGER AVAILABLE</p>
-----------------------	-------------------------	---	--	---	---

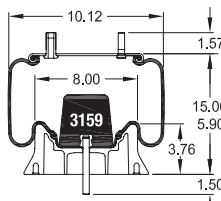
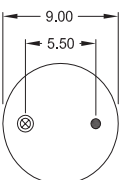
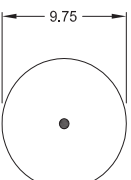
BELLOWS 1T15M2	AON W01-358-8203	 <p>CROSS SECTION</p>	 <p>BEAD PLATE TOP</p>	 <p>PISTON BOTTOM</p> <p>Order No. WC1-358-1616</p>	<p>C01-358-1131 13.06 Composite</p> <hr/> <p>APPLICATIONS: Holland (Neway) 90557210 - (replaces W01-358-8987) Wabash Trailer ArvinMeritor 2258-C-1459</p>
-----------------------	-------------------------	--	---	--	---

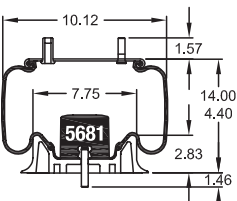
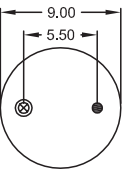
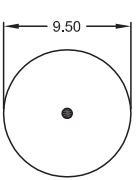
BELLOWS 1T15M2	AON W01-358-8204	 <p>CROSS SECTION</p>	 <p>BEAD PLATE TOP</p>	 <p>PISTON BOTTOM</p> <p>ORDER NO. WC1-358-1634</p>	<p>C01-358-1131 10.43 Composite</p> <hr/> <p>APPLICATIONS: Holland (Neway) 90557173 (RL196A-12) Holland (Neway) 90557223 Binkley Newlite (NS 190-16)</p>
-----------------------	-------------------------	--	---	--	--

HARDWARE KEY

- Bolt or Stud 1/2-13
- ⊗ Air Inlet 1/4 N.P.T.
- ⊗ Combination Stud/Air Inlet Stud Outside Thread is 3/4-16 Pistons
- ⊗ Exception to Standard Stud/Air Inlet Stud Inside Thread of 1/4 N.P.T.

- ▲ No Alignment Specified-Center Stud Mounting is Standard
- ⊗ Threaded Hole 3/8-16 Blind Nut on Bead Plates 1/2-13 Pistons

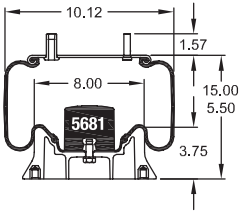
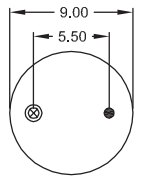
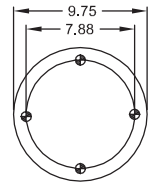
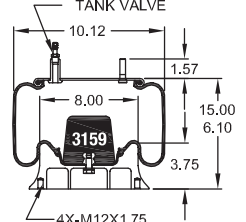
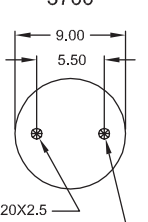
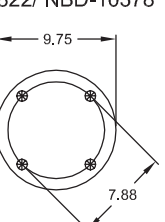
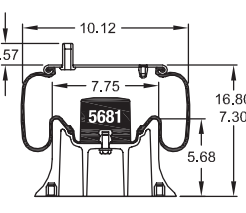
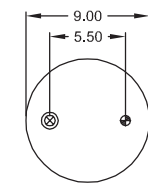
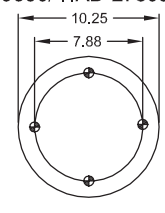
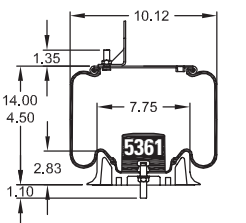
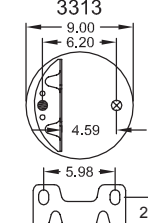
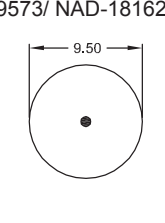
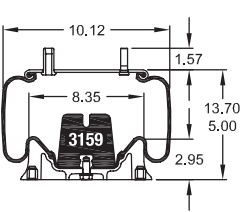
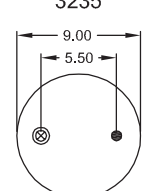
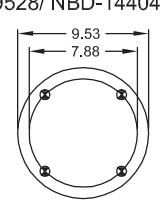
BELLOWS 1T15M2	AON W01-358-8878	C01-358-1131 11.87 Composite
 <p>CROSS SECTION</p>	 <p>BEAD PLATE TOP</p>	 <p>PISTON BOTTOM</p> <p>ORDER NO. WC1-358-1652</p> <p>APPLICATIONS: Arvin Meritor A-2258-A-1483 (WCC Front RV)</p>
BELLOWS 1T15M2	AON W01-358-8931	C01-M58-0020 15.80 Aluminum
 <p>CROSS SECTION</p>	 <p>BEAD PLATE TOP</p>	 <p>PISTON BOTTOM</p> <p>APPLICATIONS: John Deere</p>
BELLOWS 1T15M2	AON W01-358-8932	C01-358-1131 13.81 Composite
 <p>CROSS SECTION</p>	 <p>BEAD PLATE TOP</p>	 <p>PISTON BOTTOM</p> <p>ORDER NO. WC1-358-9452</p> <p>OBSELETE: NO LONGER AVAILABLE</p>
BELLOWS 1T15M2	AON W01-358-8938	C01-358-1131 12.79 Composite
 <p>CROSS SECTION</p>	 <p>BEAD PLATE TOP</p>	 <p>PISTON BOTTOM</p> <p>ORDER NO. WC1-358-1634</p> <p>APPLICATIONS:</p>
BELLOWS 1T15M2	AON W01-358-8991	C01-358-1131 12.74 Composite
 <p>CROSS SECTION</p>	 <p>BEAD PLATE TOP</p>	 <p>PISTON BOTTOM</p> <p>ORDER NO. WC1-358-0667</p> <p>APPLICATIONS: Reyco 17414-01</p>

BELLOWS 1T15M2	AON W01-358-9053	C01-358-1131	14.64	Aluminum
<p>CROSS SECTION</p>	<p>BEAD PLATE TOP</p>	<p>PISTON BOTTOM</p>	<p>APPLICATIONS: EZ Ride 8030192 Ridewell 1003589053C Fruehauf UCE-1304-2</p>	
ORDER NO. WC1-358-0652				

BELLOWS 1T15M2	AON W01-358-9078	C01-358-1131	14.04	Aluminum
<p>CROSS SECTION</p>	<p>BEAD PLATE TOP</p>	<p>PISTON BOTTOM</p>	<p>APPLICATIONS: Fruehauf UCB-9668-1 Fruehauf MFR-022355</p>	
ORDER NO. WC1-358-0658				

BELLOWS 1T15M2	AON W01-358-9105	C01-358-1131	12.80	Composite
<p>CROSS SECTION</p>	<p>BEAD PLATE TOP</p>	<p>PISTON BOTTOM</p>	<p>SERVICE ASSEMBLY W01-358-0725</p> <p>APPLICATIONS: Hendrickson Trailer S1245 Granning 5065 Ridewell 1003589105C Watson & Chalin AS-0015</p>	
ORDER NO. WC1-358-1652				

BELLOWS 1T15M2	AON W01-358-9118	C01-358-1131	14.29	Aluminum
<p>CROSS SECTION</p>	<p>BEAD PLATE TOP</p>	<p>PISTON BOTTOM</p>	<p>APPLICATIONS: Ridewell 1003589118C</p> <p>OBsolete: NO LONGER AVAILABLE</p>	
ORDER NO. WC1-358-0652				

BELLOWS 1T15M2	AON W01-358-9303	C01-358-1131	13.22	Composite
<p>CROSS SECTION</p>	<p>BEAD PLATE TOP</p>	<p>PISTON BOTTOM</p>	<p>APPLICATIONS:</p>	

HARDWARE KEY

- Bolt or Stud 1/2-13
- ⊗ Air Inlet 1/4 N.P.T.
- ⊗ Combination Stud/Air Inlet Stud Outside Thread is 3/4-16 Pistons
- ⊗ Exception to Standard Stud/Air Inlet Stud Inside Thread of 1/4 N.P.T.

- ▲ No Alignment Specified-Center Stud Mounting is Standard
- ⊗ Threaded Hole 3/8-16 Blind Nut on Bead Plates 1/2-13 Pistons

BELLOWS 1T15M2	AON W01-358-9325	C01-358-1131 13.64 Composite
<p>CROSS SECTION</p>	3235 <p>BEAD PLATE TOP</p> 9532/ NAD-29827 <p>PISTON BOTTOM</p> ORDER NO. WC1-358-1619	APPLICATIONS: Holland (Neway) 90557149
BELLOWS 1T15M2	AON W01-358-9339	C01-358-1131 11.96 Composite
<p>CROSS SECTION</p>	3313 <p>BEAD PLATE TOP</p> 9570/ NAD-18162 <p>PISTON BOTTOM</p> ORDER NO. WC1-358-0647	BRACKET WC1-358-3903 APPLICATIONS: Hendrickson 56808-2 (class 6 Ford) Hendrickson 57150 RH Hendrickson 57140 LH - Remove new bracket and reuse old (class 6&7 GM) OBSOLETE: NO LONGER AVAILABLE
BELLOWS 1T15M2	AON W01-358-9365	C01-358-1131 12.45 Composite
<p>CROSS SECTION</p>	3235 <p>BEAD PLATE TOP</p> 6836/FIP-104972 OR 9544/NAD-29826 <p>PISTON BOTTOM</p> ORDER NO. WC1-358-0666	APPLICATIONS: Holland (Neway) 90557159
BELLOWS 1T15M2	AON W01-358-9366	C01-358-1131 11.82 Composite
<p>CROSS SECTION</p>	3235 <p>BEAD PLATE TOP</p> 9549/ NAD-29454 <p>PISTON BOTTOM</p> ORDER NO. WC1-358-1616	APPLICATIONS: Holland (Neway) 90557160 Holland (Neway) 90557210 Holland (Neway) 90557225 Watson & Chalin AS-0054 Wabash Holland (Neway) 90557225
BELLOWS 1T15M2	AON W01-358-9807	C01-358-1131 11.00 Composite
<p>CROSS SECTION</p>	3235 <p>BEAD PLATE TOP</p> 9489/FIP-101211 <p>PISTON BOTTOM</p> Order No. WC1-358-1660	APPLICATIONS: Spacer Options WC1-358-1690 WC1-358-1691 WC1-358-1692 (see specs for each following) Holland 90557372 50857000

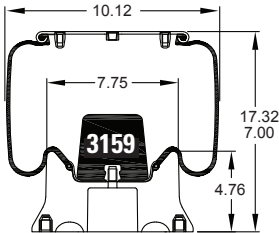
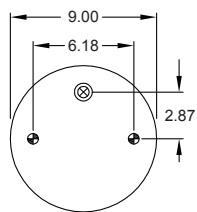
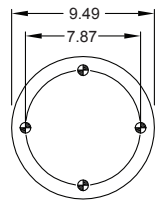
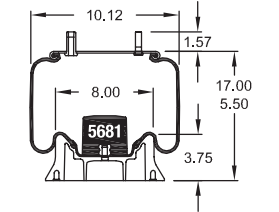
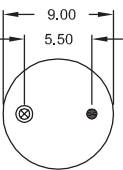
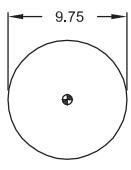
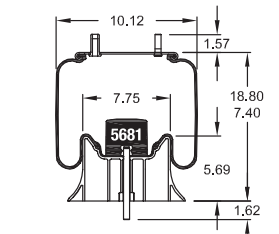
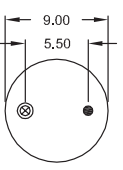
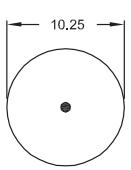
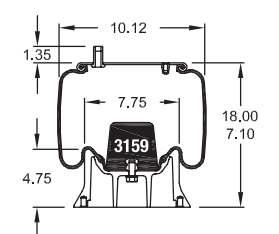
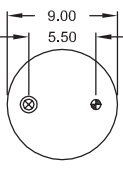
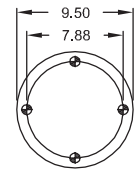
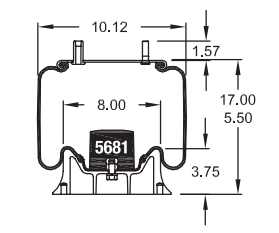
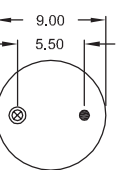
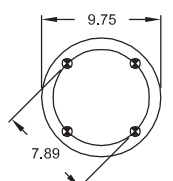
<p>BELLOWS 1T15M4</p>  <p>CROSS SECTION</p>	<p>AON W01-358-0742</p>  <p>BEAD PLATE TOP</p>  <p>PISTON BOTTOM</p>	<p>C01-358-2145 10.54 N/A</p> <p>APPLICATIONS:</p>
<p>BELLOWS 1T15M4</p>  <p>CROSS SECTION</p>	<p>AON W01-358-8802</p> <p>3235 9549/ NAD-29454</p>  <p>BEAD PLATE TOP</p>  <p>PISTON BOTTOM</p> <p>ORDER NO. WC1-358-1616</p>	<p>C01-358-2145 12.04 Composite</p> <p>APPLICATIONS: Ridewell 1003588802C Holland (Neway) 90557170</p>
<p>BELLOWS 1T15M4</p>  <p>CROSS SECTION</p>	<p>AON W01-358-8803</p> <p>3235 9532/ NAD-29827</p>  <p>BEAD PLATE TOP</p>  <p>PISTON BOTTOM</p> <p>ORDER NO. WC1-358-1619</p>	<p>C01-358-2145 13.09 Composite</p> <p>APPLICATIONS: Ridewell 1003588803C Holland (Neway) 90557194 (Dock-Mate)</p>
<p>BELLOWS 1T15M4</p>  <p>CROSS SECTION</p>	<p>AON W01-358-8805</p> <p>3210 9727/ NBD-8725</p>  <p>BEAD PLATE TOP</p>  <p>PISTON BOTTOM</p> <p>ORDER NO. WC1-358-0651</p>	<p>C01-358-2145 16.18 Aluminum</p> <p>APPLICATIONS: Ridewell 1003588805C</p>
<p>BELLOWS 1T15M4</p>  <p>CROSS SECTION</p>	<p>AON W01-358-8806</p> <p>3235 9656/ NBD-10267</p>  <p>BEAD PLATE TOP</p>  <p>PISTON BOTTOM</p> <p>ORDER NO. WC1-358-0652</p>	<p>C01-358-2145 14.00 Aluminum</p> <p>APPLICATIONS: Ridewell 1003588806C</p>

HARDWARE KEY

- Bolt or Stud 1/2-13
- ⊗ Air Inlet 1/4 N.P.T.
- ⊗ Combination Stud/Air Inlet Stud Outside Thread is 3/4-16 Pistons
- ⊗ Exception to Standard Stud/Air Inlet Stud Inside Thread of 1/4 N.P.T.

- ▲ No Alignment Specified-Center Stud Mounting is Standard
- ⊗ Threaded Hole 3/8-16 Blind Nut on Bead Plates 1/2-13 Pistons

BELLOWS 1T15M4	AON W01-358-8810	C01-358-2145 15.03 Aluminum
<p>CROSS SECTION</p>	<p>3271 BEAD PLATE TOP</p> <p>9656/ NBD-10267 PISTON BOTTOM</p> <p>ORDER NO. WC1-358-0652</p>	<p>APPLICATIONS: Hagie</p>
BELLOWS 1T15M4	AON W01-358-8813	C01-358-2145 12.62 Composite
<p>CROSS SECTION</p>	<p>3202 BEAD PLATE TOP</p> <p>9544/ NAD-29826 PISTON BOTTOM</p> <p>ORDER NO. WC1-358-0666</p>	<p>APPLICATIONS: Kenworth C81-1003 Airglide 380 Peterbilt C81-6000 Flex Air</p>
BELLOWS 1T15M4	AON W01-358-8816	C01-358-2145 13.19 Composite
<p>CROSS SECTION</p>	<p>3004 BEAD PLATE TOP</p> <p>9573/ NAD-18162 PISTON BOTTOM</p> <p>ORDER NO. WC1-358-1634</p>	<p>BRACKET WC1-358-3904</p> <p>APPLICATIONS: Hendrickson 60929-2</p>
BELLOWS 1T15M4	AON W01-358-8817	C01-358-2145 13.46 Composite
<p>CROSS SECTION</p>	<p>3004 BEAD PLATE TOP</p> <p>9573/ NAD-18162 PISTON BOTTOM</p> <p>ORDER NO. WC1-358-1634</p>	<p>BRACKET WC1-358-3904</p> <p>APPLICATIONS: Hendrickson 60925-2</p> <p>OBSOLETE: NO LONGER AVAILABLE</p>
BELLOWS 1T15M4	AON W01-358-9010	C01-358-2145 16.14 Aluminum
<p>CROSS SECTION</p>	<p>3235 BEAD PLATE TOP</p> <p>9727/ NBD-8725 PISTON BOTTOM</p> <p>ORDER NO. WC1-358-0651</p>	<p>APPLICATIONS: Ridewell 1003589010C (replaces 9064) Reyco 12928-01 Hendrickson Trailer S2827 Hendrickson Trailer S11566 (remove bolt) Watson & Chalin AS-0044</p>

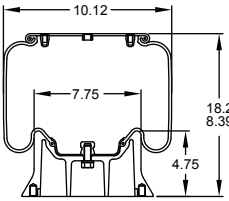
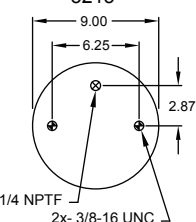
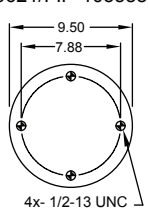
BELLOWS 1T15M4	AON W01-358-9056	C01-358-2145	13.65	Aluminum
 <p>CROSS SECTION</p>	<p>3215</p>  <p>BEAD PLATE TOP</p>	<p>9621/FIP-103588</p>  <p>PISTON BOTTOM</p>	<p>APPLICATIONS: DAF 656991</p>	

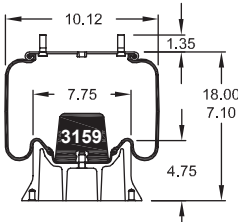
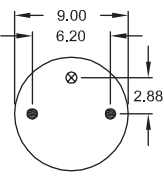
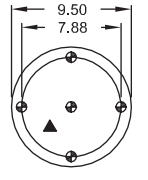
BELLOWS 1T15M4	AON W01-358-9059	C01-358-2145	16.32	Aluminum
 <p>CROSS SECTION</p>	<p>3220</p>  <p>BEAD PLATE TOP</p>	<p>9727/ NBD-8725</p>  <p>PISTON BOTTOM</p> <p>ORDER NO. WC1-358-0651</p>	<p>APPLICATIONS: Hutchens H-1913-1</p>	

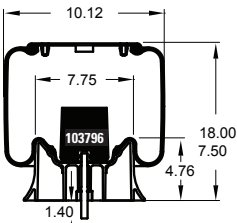
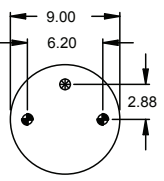
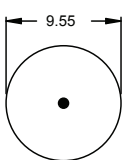
BELLOWS 1T15M4	AON W01-358-9069	C01-358-2145	14.23	Composite
 <p>CROSS SECTION</p>	<p>3202</p>  <p>BEAD PLATE TOP</p>	<p>6836/FIP-103972 OR 9544/NAD-29826</p>  <p>PISTON BOTTOM</p> <p>ORDER NO. WC1-358-0666</p>	<p>APPLICATIONS: Peterbilt 03-02456 Peterbilt 03-04759 Peterbilt 03-01649 Peterbilt 03-06746 Peterbilt 03-07112 Peterbilt 03-02038 (Air-Trac) MFG.SV# Peterbilt 03-10042</p>	

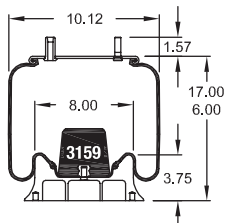
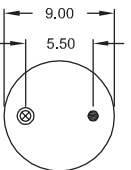
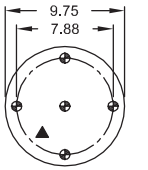
BELLOWS 1T15M4	AON W01-358-9070	C01-358-2145	15.25	Aluminum
 <p>CROSS SECTION</p>	<p>3235</p>  <p>BEAD PLATE TOP</p>	<p>9656/ NBD-10267</p>  <p>PISTON BOTTOM</p> <p>ORDER NO. WC1-358-0652</p>	<p>APPLICATIONS: Holland (Neway) 90557038 Holland (Neway) 90557090 (AR-90-1-12) Silent Drive</p>	

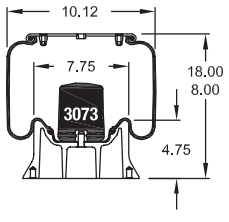
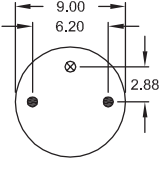
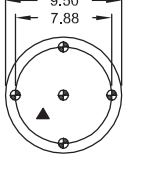
BELLOWS 1T15M4	AON W01-358-9071	C01-358-2145	16.08	Aluminum
 <p>CROSS SECTION</p>	<p>3215</p>  <p>BEAD PLATE TOP</p>	<p>9727/ NBD-8725</p>  <p>PISTON BOTTOM</p> <p>ORDER NO. WC1-358-0651</p>	<p>APPLICATIONS: Fab Tek (West Unit) 101357 Ridewell 1003589071C Pioneer Trailer</p>	

HARDWARE KEY

- Bolt or Stud 1/2-13
- ⊗ Air Inlet 1/4 N.P.T.
- ⊗ Combination Stud/Air Inlet Stud Outside Thread is 3/4-16 Pistons
- ⊗ Exception to Standard Stud/Air Inlet Stud Inside Thread of 1/4 N.P.T.

- ▲ No Alignment Specified-Center Stud Mounting is Standard
- ⊗ Threaded Hole 3/8-16 Blind Nut on Bead Plates 1/2-13 Pistons

BELLOWS 1T15M4	AON W01-358-9335	C01-358-2145 12.34 Composite
<p>CROSS SECTION</p>	<p>BEAD PLATE TOP</p> <p>PISTON BOTTOM</p> <p>ORDER NO. WC1-358-1634</p>	BRACKET WC1-358-3903 APPLICATIONS: Hendrickson 56917 - 1 & 2 (Class6&7 Freightliner) -ref.56916 (W01-358-9284) Superseded
BELLOWS 1T15M4	AON W01-358-9336	C01-358-2145 13.38 Composite
<p>CROSS SECTION</p>	<p>BEAD PLATE TOP</p> <p>PISTON BOTTOM</p> <p>ORDER NO. WC1-358-1616</p>	APPLICATIONS: Watson & Chalin AS-0053
BELLOWS 1T15M4	AON W01-358-9467	C01-358-2145 18.58 Composite
<p>CROSS SECTION</p>	<p>BEAD PLATE TOP</p> <p>PISTON BOTTOM</p>	APPLICATIONS: Ridewell 1003589467C OBSOLETE: NO LONGER AVAILABLE
BELLOWS 1T15M4	AON W01-358-9482	C01-358-2145 14.91 Composite
<p>CROSS SECTION</p>	<p>BEAD PLATE TOP</p> <p>PISTON BOTTOM</p> <p>ORDER NO. WC1-358-1616</p>	BRACKET WC1-358-3887 APPLICATIONS: Holland (Neway) 90557161 (AD200-7) (Gillig) - ref. W01-358-9585 (1/ 2" NPT)
BELLOWS 1T15M4	AON W01-358-9484	C01-358-2145 12.87 Composite
<p>CROSS SECTION</p>	<p>BEAD PLATE TOP</p> <p>PISTON BOTTOM</p> <p>ORDER NO. WC1-358-0666</p>	APPLICATIONS: Holland (Neway) 90557158



<p>BELLOWS 1T15M4</p>	<p>AON W01-358-9507</p>	<p>C01-358-2145 16.23 Aluminum</p>
<p>CROSS SECTION</p>	<p>BEAD PLATE TOP</p>	<p>9727/ NBD-8724</p> <p>PISTON BOTTOM</p> <p>ORDER NO. WC1-358-0651</p> <p>BRACKET WC1-358-3887</p> <p>APPLICATIONS: Holland (Neway) 90557313</p>
<p>BELLOWS 1T15M4</p>	<p>AON W01-358-9585</p>	<p>C01-358-2145 15.41 Composite</p>
<p>CROSS SECTION</p>	<p>BEAD PLATE TOP</p>	<p>9549/ NAD-29454</p> <p>PISTON BOTTOM</p> <p>ORDER NO. WC1-358-1616</p> <p>BRACKET WC1-358-3887</p> <p>APPLICATIONS: Holland (Neway) 90557247 (replaces 90557219-flush fitting) - ref.W01-358-9482</p> <p>OBSOLETE: NO LONGER AVAILABLE</p>
<p>BELLOWS 1T15M4</p>	<p>AON W01-358-9697</p>	<p>C01-358-2145 13.25 Composite</p>
<p>CROSS SECTION</p>	<p>BEAD PLATE TOP</p>	<p>9532/ NAD-29827</p> <p>PISTON BOTTOM</p> <p>ORDER NO. WC1-358-1619</p> <p>APPLICATIONS: Holland 90557329</p>
<p>BELLOWS 1T15M4</p>	<p>AON W01-358-9797</p>	<p>C01-358-2145 13.86 Aluminum</p>
<p>CROSS SECTION</p>	<p>BEAD PLATE TOP</p>	<p>9656 / NBD-10440</p> <p>PISTON BOTTOM</p> <p>ORDER NO. WC1-358-0652</p> <p>APPLICATIONS: Ridewell 1003589797C</p>
<p>BELLOWS 1T15M4</p>	<p>AON W01-358-9978</p>	<p>C01-358-2145 14.10 Composite</p>
<p>CROSS SECTION</p>	<p>BEAD PLATE TOP</p>	<p>9484/FIP-101468</p> <p>PISTON BOTTOM</p> <p>Order No. WC1-358-1674</p> <p>APPLICATIONS: Hendrickson S-28929</p>



HARDWARE KEY



- Bolt or Stud 1/2-13
- ⊗ Air Inlet 1/4 N.P.T.
- ⊗ Combination Stud/Air Inlet Stud Outside Thread is 3/4-16 Pistons
- ⊗ Exception to Standard Stud/Air Inlet Stud Inside Thread of 1/4 N.P.T.

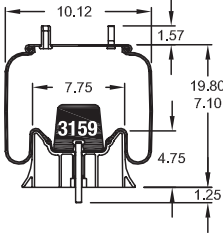
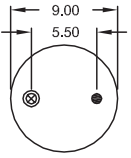
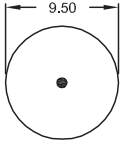

- ▲ No Alignment Specified-Center Stud Mounting is Standard
- ⊗ Threaded Hole 3/8-16 Blind Nut on Bead Plates 1/2-13 Pistons

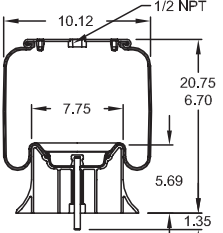
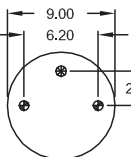
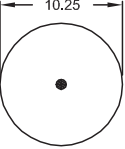

<p>BELLOWS 1T15M6</p>	<p>AON W01-358-1096</p>	<p>C01-358-2149 14.55 Aluminum</p>	
<p>CROSS SECTION</p>	<p>3226</p> <p>LOCATING PIN</p>	<p>9656/NBD-10440</p> <p>Order No. WC1-358-0652</p>	<p>APPLICATIONS: Goodyear 1R12-494 566243142</p>
<p>BELLOWS 1T15M6</p>	<p>AON W01-358-8591</p>	<p>C01-358-2149 15.92 Composite</p>	
<p>CROSS SECTION</p>	<p>3313</p> <p>BEAD PLATE TOP</p>	<p>9538/NAD-27740</p> <p>Order No. WC1-358-1628</p>	<p>APPLICATIONS: Volvo 3180673</p> <p>OBSELETE: NO LONGER AVAILABLE</p>
<p>BELLOWS 1T15M6</p>	<p>AON W01-358-8824</p>	<p>C01-358-2149 13.88 Composite</p>	
<p>CROSS SECTION</p>	<p>3242</p> <p>BEAD PLATE TOP</p>	<p>9530 NAD-27809 PL</p> <p>Order No. WC1-358-9452 PL</p>	<p>APPLICATIONS: Tuthill-Reyco 702614-01</p>
<p>BELLOWS 1T15M6</p>	<p>AON W01-358-8825</p>	<p>C01-358-2149 13.74 Composite</p>	
<p>CROSS SECTION</p>	<p>3192</p> <p>LOCATING PIN</p>	<p>9530/NAD-27809</p> <p>Order No. WC1-358-9452</p>	<p>APPLICATIONS: Watson & Chalin AS-0113 Goodyear 1R12-541</p> <p>OBSELETE: NO LONGER AVAILABLE</p>
<p>BELLOWS 1T15M6</p>	<p>AON W01-358-8924</p>	<p>C01-358-2149 14.89 Composite</p>	
<p>CROSS SECTION</p>	<p>3210</p> <p>BEAD PLATE TOP</p>	<p>9530 NAD-27809</p> <p>Order No. WC1-358-9452</p>	<p>APPLICATIONS: Ridewell 1003588924C</p>

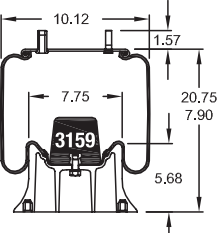
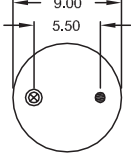
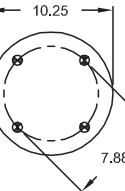
BELLOWS 1T15M6	AON W01-358-8927	 C01-358-2149  14.54  Composite	
 <p>CROSS SECTION</p>	<p>3235</p>  <p>BEAD PLATE TOP</p>	<p>9544/ NAD-29826</p>  <p>PISTON BOTTOM</p> <p>ORDER NO. WC1-358-0666</p>	<p>APPLICATIONS: Watson & Chalin AS-0062</p> <p>OBSOLETE: NO LONGER AVAILABLE</p>

BELLOWS 1T15M6	AON W01-358-9026	 C01-358-2149  12.70  Composite	
 <p>CROSS SECTION</p>	<p>3202</p>  <p>BEAD PLATE TOP</p>	<p>9532/ NAD-29827</p>  <p>PISTON BOTTOM</p> <p>ORDER NO. WC1-358-1619</p>	<p>APPLICATIONS: Peterbilt 03-06213 Peterbilt 03-07111 (Low Air Leaf)</p>

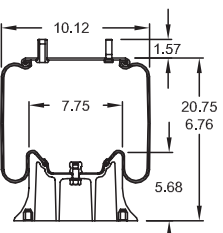
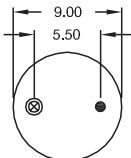
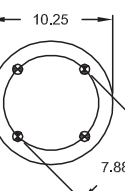
BELLOWS 1T15M6	AON W01-358-9082	 C01-358-2149  14.59  Composite	
 <p>CROSS SECTION</p>	<p>3235</p>  <p>BEAD PLATE TOP</p>	<p>9530/ NAD-27809</p>  <p>PISTON BOTTOM</p> <p>ORDER NO. WC1-358-9452</p>	<p>SERVICE ASSEMBLY W01-358-0712</p> <p>APPLICATIONS: Hendrickson Can. S2066, S11651, B-12514-007 Kelderman Hutchens H-9630-01 Kwik Lok/ToDo (Jifflox) CP-5125 Holland (Neway) 90557006, 90557027, 90557033 (special mounting), 90557037, 90557054, 90557075 Reyco 12882-01, R & S Truck & body 1090217 Ridewell 1003589082C, Silent Drive, Watson & Chalin AS-0011</p>

BELLOWS 1T15M6	AON W01-358-9083	 C01-358-2149  13.22  Composite	
 <p>CROSS SECTION</p>	<p>3235</p>  <p>BEAD PLATE TOP</p>	<p>9530/ NAD-27809</p>  <p>PISTON BOTTOM</p> <p>ORDER NO. WC1-358-9452</p>	<p>SERVICE ASSEMBLY W01-358-9080</p> <p>APPLICATIONS: Granning 1359 Watson & Chalin AS-0028 Ridewell 1003589083C Hendrickson Trailer S1561</p>

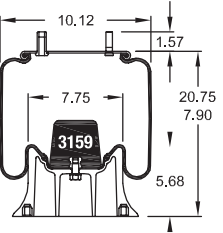
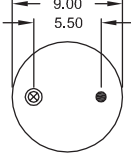
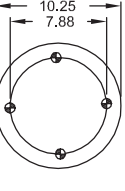
BELLOWS 1T15M6	AON W01-358-9092	 C01-358-2149  15.11  Composite	
 <p>CROSS SECTION</p>	<p>3235</p>  <p>BEAD PLATE TOP</p>	<p>9530/ NBD-21809</p>  <p>PISTON BOTTOM</p> <p>ORDER NO. WC1-358-9452</p>	<p>APPLICATIONS: Holland (Neway) 90557031 Hendrickson Can. S12353</p>

HARDWARE KEY

- Bolt or Stud 1/2-13
- ⊗ Air Inlet 1/4 N.P.T.
- ⊗ Combination Stud/Air Inlet Stud Outside Thread is 3/4-16 Pistons
- ⊗ Exception to Standard Stud/Air Inlet Stud Inside Thread of 1/4 N.P.T.

- ▲ No Alignment Specified-Center Stud Mounting is Standard
- ⊗ Threaded Hole 3/8-16 Blind Nut on Bead Plates 1/2-13 Pistons

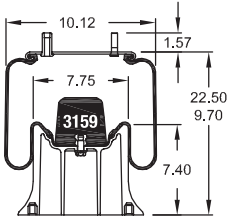
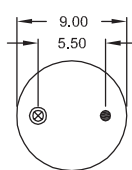
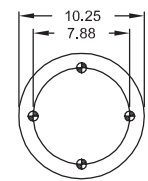
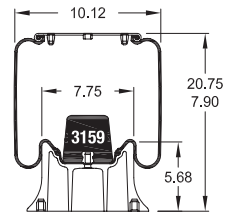
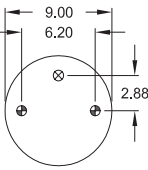
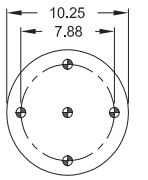
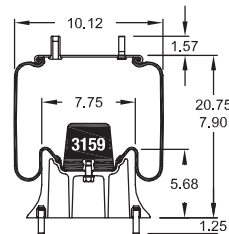
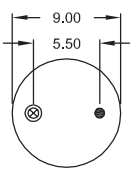
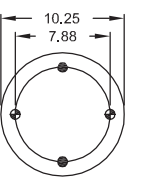
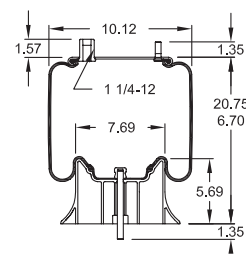
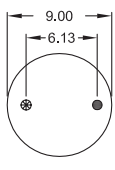
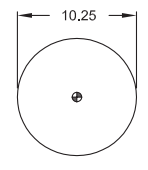
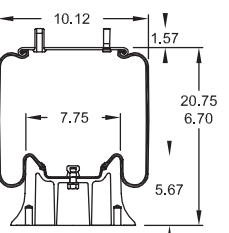
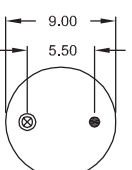
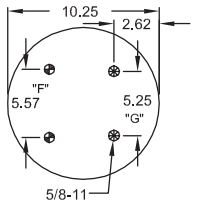
BELLOWS 1T15M6	AON W01-358-9093	C01-358-2149 15.98 Composite
 <p>CROSS SECTION</p>	 <p>3235 BEAD PLATE TOP</p>  <p>9553/ NBD-29457 PISTON BOTTOM</p> <p>ORDER NO. WC1-358-9453</p>	SERVICE ASSEMBLY W01-358-0712 APPLICATIONS: Holland (Neway) 90557007 Holland (Neway) 90557032 Holland (Neway) 90557035
BELLOWS 1T15M6	AON W01-358-9096	C01-358-2149 14.79 Composite
 <p>CROSS SECTION</p>	 <p>3215 BEAD PLATE TOP</p>  <p>9530/NAD-27809 PISTON BOTTOM</p> <p>Order No. WC1-358-9452</p>	SERVICE ASSEMBLY W01-358-0707 APPLICATIONS: Fruehauf UCE-1304-1
BELLOWS 1T15M6	AON W01-358-9193	C01-358-2149 15.09 Composite
 <p>CROSS SECTION</p>	 <p>3235 BEAD PLATE TOP</p>  <p>9530/ NAD-27809 PISTON BOTTOM</p> <p>ORDER NO. WC1-358-9452</p>	APPLICATIONS: Holland (Neway) 90557101 REPLACEMENT PISTON COMES WITHOUT STUDS OBSELETE: NO LONGER AVAILABLE
BELLOWS 1T15M6	AON W01-358-9194	C01-358-2149 12.99 Composite
 <p>CROSS SECTION</p>	 <p>3246 BEAD PLATE TOP</p>  <p>9532/NAD-29827 PISTON BOTTOM</p> <p>Order No. WC1-358-1619</p>	APPLICATIONS: Peterbilt 03-05107
BELLOWS 1T15M6	AON W01-358-9210	C01-358-2149 15.88 Aluminum
 <p>CROSS SECTION</p>	 <p>3235 BEAD PLATE TOP</p>  <p>9951/ NAD-17833 PISTON BOTTOM</p> <p>ORDER NO. WC1-358-0697</p>	SERVICE ASSEMBLY W01-358-9080 APPLICATIONS: Granning 2577

BELLOWS 1T15M6	AON W01-358-9211	C01-358-2149	17.34	Aluminum
<p>CROSS SECTION</p>	<p>3235 BEAD PLATE TOP</p>	<p>9951/ NAD-17833 PISTON BOTTOM ORDER NO. WC1-358-0697</p>	SERVICE ASSEMBLY W01-358-0712 APPLICATIONS: Granning 2692 OBSOLETE: NO LONGER AVAILABLE	

BELLOWS 1T15M6	AON W01-358-9213	C01-358-2149	13.29	Composite
<p>CROSS SECTION</p>	<p>3291 BEAD PLATE TOP</p>	<p>9560/ NAD-32768 PISTON BOTTOM ORDER NO. WC1-358-1620</p>	SERVICE ASSEMBLY W01-358-0748 APPLICATIONS: Navistar 501559C-1 Navistar 501559C-2 Navistar 1660581C-1	

BELLOWS 1T15M6	AON W01-358-9219	C01-358-2149	13.54	Composite
<p>CROSS SECTION</p>	<p>3279 BEAD PLATE TOP</p>	<p>9560/ NAD-32768 PISTON BOTTOM ORDER NO. WC1-358-1620</p>	APPLICATIONS: Volvo/GM Heavy Duty Truck 35003-3201 Volvo/GM Heavy Duty Truck 35203-3202 Volvo/GM Heavy Duty Truck 35003-3204 Volvo/GM Heavy Duty Truck 35003-3209	

BELLOWS 1T15M6	AON W01-358-9223	C01-358-2149	20.57	Composite
<p>CROSS SECTION</p>	<p>3235 BEAD PLATE TOP</p>	<p>9583/FIP-101543 PISTON BOTTOM</p>	APPLICATIONS: Reyco 12884-01 Reyco 12884-01A (102AR) Hendrickson 48195-2 REPLACES 1T15LX8	

BELLOWS 1T15M6	AON W01-358-9227	C01-358-2149	14.98	Composite
<p>CROSS SECTION</p>	<p>3188 BEAD PLATE TOP</p>	<p>9530/ NAD-27809 PISTON BOTTOM ORDER NO. WC1-358-9452</p>	APPLICATIONS: Hendrickson Trailer S2924 Hendrickson 48195-1 (b.plate studs-1.35) (2 studs in piston at 90deg alignment)	

HARDWARE KEY

- Bolt or Stud 1/2-13
- ⊗ Air Inlet 1/4 N.P.T.
- ⊗ Combination Stud/Air Inlet Stud Outside Thread is 3/4-16 Pistons
- ⊗ Exception to Standard Stud/Air Inlet Stud Inside Thread of 1/4 N.P.T.

- ▲ No Alignment Specified-Center Stud Mounting is Standard
- ⊗ Threaded Hole 3/8-16 Blind Nut on Bead Plates 1/2-13 Pistons

BELLOWS 1T15M6	AON W01-358-9296	C01-358-2149 14.39 Composite
<p>CROSS SECTION</p>	<p>3254 BEAD PLATE TOP</p>	9560/ NAD-32768 <p>PISTON BOTTOM ORDER NO. WC1-358-1620</p>
BRACKET WC1-358-3873 APPLICATIONS: Volvo/GM 8061151 Volvo/GM 8169868		
BELLOWS 1T15M6	AON W01-358-9304	C01-358-2149 16.20 Composite
<p>CROSS SECTION</p>	<p>3235 BEAD PLATE TOP</p>	9540/ NAD-29828 <p>PISTON BOTTOM ORDER NO. WC1-358-0664</p>
APPLICATIONS: Holland (Neway) 90557124 (AR-90115 & 16) Watson & Chalin AS-0059		
BELLOWS 1T15M6	AON W01-358-9362	C01-358-2149 14.88 Composite
<p>CROSS SECTION</p>	<p>3235 BEAD PLATE TOP</p>	9532/ NAD-29827 <p>PISTON BOTTOM ORDER NO. WC1-358-1619</p>
APPLICATIONS: Watson & Chalin AS-0049 Holland (Neway) 90557113 (AR90-1-14&17) (AR75-6&9)		
BELLOWS 1T15M6	AON W01-358-9392	C01-358-2149 16.02 Composite
<p>CROSS SECTION</p>	<p>3235 BEAD PLATE TOP</p>	9553/ NAD-29457 <p>PISTON BOTTOM ORDER NO. WC1-358-9453</p>
SERVICE ASSEMBLY W01-358-0712 APPLICATIONS: Hendrickson Trailer S4773		
BELLOWS 1T15M6	AON W01-358-9466	C01-358-2149 14.33 Composite
<p>CROSS SECTION</p>	<p>3271 BEAD PLATE TOP</p>	9561 / NAD-32767 <p>PISTON BOTTOM ORDER NO. WC1-358-1606</p>
APPLICATIONS: Hendrickson 49048 (Ford) Hendrickson 49674-1&2 (Mack) (57QL411M) Hendrickson 49207 (Marmon) HA-360/400/460 [up to 1991]		

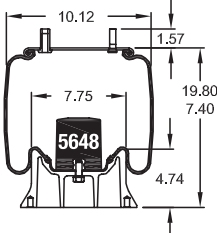
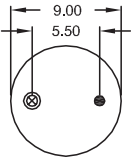
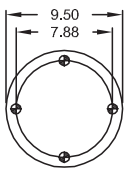
BELLOWS 1T15M6	AON W01-358-9474	 <p>CROSS SECTION</p>	 <p>3235 BEAD PLATE TOP</p>	 <p>9727/ NBD-8724 PISTON BOTTOM</p>	<p>C01-358-2149 15.12 Aluminum</p> <hr/> <p>APPLICATIONS: Reyco 20966-01 Everly</p>
-----------------------	-------------------------	--	--	---	--

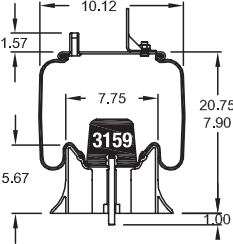
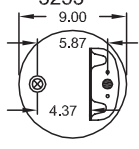
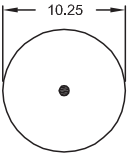
BELLOWS 1T15M6	AON W01-358-9496	 <p>CROSS SECTION</p>	 <p>3253 BEAD PLATE TOP</p>	 <p>9532/ NAD-29827 PISTON BOTTOM</p>	<p>C01-358-2149 15.19 Composite</p> <hr/> <p>BRACKET WC1-358-3887</p> <p>APPLICATIONS: Holland (Neway) 90557208</p> <p>OBSOLETE: NO LONGER AVAILABLE</p>
-----------------------	-------------------------	--	--	--	---

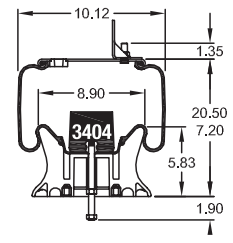
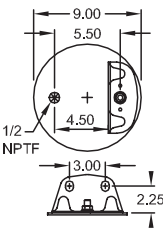
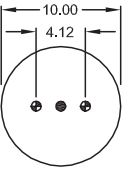
BELLOWS 1T15M6	AON W01-358-9966	 <p>CROSS SECTION</p>	 <p>3310 BEAD PLATE TOP</p>	 <p>9583/FIP-101543 Order No. WC1-358-0660 PISTON BOTTOM</p>	<p>C01-358-2149 22.36 Aluminum</p> <hr/> <p>APPLICATIONS: Reyco 20124-02 (1/2 NPT) Reyco 20124-01 Reyco 20124-01K (1/4 NPT) - [Use 1/2 to 1/4 NPT adaptor]</p>
-----------------------	-------------------------	---	---	--	---

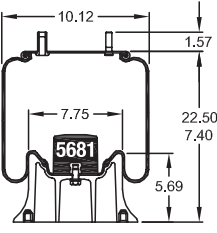
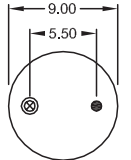
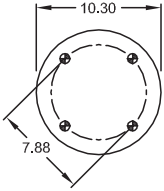
BELLOWS 1T15M7.5	AON W01-358-8888	 <p>CROSS SECTION</p>	 <p>3235 BEAD PLATE TOP</p>	 <p>9530 / NAD-27809 ORDER NO. WC1-358-9452 PISTON BOTTOM</p>	<p>C01-358-2197 13.99 Composite</p> <hr/> <p>APPLICATIONS: Rowe Truck 0027 ASC2500</p>
-------------------------	-------------------------	--	--	--	---

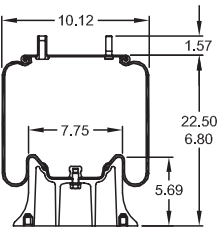
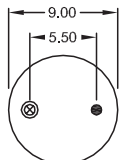
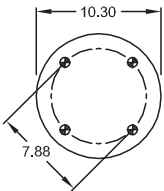
BELLOWS 1T15M7.5	AON W01-358-9342	 <p>CROSS SECTION</p>	 <p>3235 BEAD PLATE TOP</p>	 <p>9530 / NAD-27809 ORDER NO. WC1-358-9452 PISTON BOTTOM</p>	<p>C01-358-2197 13.65 Composite</p> <hr/> <p>APPLICATIONS: Granning 2727 (supersedes 9298) Chalmers (remove bolt) - Suspension should have axle stops - if not: use W01-358-9245</p>
-------------------------	-------------------------	--	--	--	---

HARDWARE KEY

- Bolt or Stud 1/2-13
- ⊗ Air Inlet 1/4 N.P.T.
- ⊗ Combination Stud/Air Inlet Stud Outside Thread is 3/4-16 Pistons
- ⊗ Exception to Standard Stud/Air Inlet Stud Inside Thread of 1/4 N.P.T.

- ▲ No Alignment Specified-Center Stud Mounting is Standard
- ⊗ Threaded Hole 3/8-16 Blind Nut on Bead Plates 1/2-13 Pistons

<p>BELLOWS 1T15M75</p>	<p>AON W01-358-9902</p>	<p>C01-358-2197 14.70 Composite</p>
<p>CROSS SECTION</p>	<p>3249 BEAD PLATE TOP</p> <p>9544/NAD-29826 PISTON BOTTOM</p> <p>Order No. WC1-358-0666</p>	<p>APPLICATIONS: Holland (Neway) 90557138</p>
<p>BELLOWS 1T15M75</p>	<p>AON W01-358-9921</p>	<p>C01-358-2197 13.70 Composite</p>
<p>CROSS SECTION</p>	<p>3235 BEAD PLATE TOP</p> <p>9544 / NAD-29826 PISTON BOTTOM</p> <p>ORDER NO. WC1-358-0666</p>	<p>APPLICATIONS: Holland (Neway) 90557117 (AR92-12 & 14), (AR93-14) Watson & Chalin AS-0090 Silent Drive</p>
<p>BELLOWS 1T15M75</p>	<p>AON W01-358-9922</p>	<p>C01-358-2197 15.04 Composite</p>
<p>CROSS SECTION</p>	<p>3235 BEAD PLATE TOP</p> <p>9540/NAD-29828 PISTON BOTTOM</p> <p>Order No. WC1-358-0664</p>	<p>APPLICATIONS: Holland (Neway) 90557119 (AR92-17) (AR93-17)</p>
<p>BELLOWS 1T15M75</p>	<p>AON W01-358-9923</p>	<p>C01-358-2197 13.74 Composite</p>
<p>CROSS SECTION</p>	<p>3235 BEAD PLATE TOP</p> <p>9532 / NAD-29827 PISTON BOTTOM</p> <p>ORDER NO. WC1-358-1619</p>	<p>APPLICATIONS: Holland (Neway) 90557118 (AR92 & 93-15&16)</p>
<p>BELLOWS 1T15M75</p>	<p>AON W01-358-9935</p>	<p>C01-358-2197 13.81 Composite</p>
<p>CROSS SECTION</p>	<p>3226 BEAD PLATE TOP</p> <p>9532/NAD-29827 PISTON BOTTOM</p> <p>Order No. WC1-358-1619</p>	<p>APPLICATIONS: Holland (Neway) 90557157 (RL-228-17) Holland (Neway) 90557301</p>

BELLOWS 1T15M7.5	AON W01-358-9936	C01-358-2197 13.91 Composite
<p>CROSS SECTION</p>	<p>3226 BEAD PLATE TOP</p>	<p>9544/NAD-29826 PISTON BOTTOM Order No. WC1-358-0666</p>
<p>APPLICATIONS: Holland (Neway) 90557156 (RL-228-14,15,16) Holland (Neway) 90557300</p>		

BELLOWS 1T15M7.5	AON W01-358-9942	C01-358-2197 14.14 Composite
<p>CROSS SECTION</p>	<p>3249 BEAD PLATE TOP</p>	<p>9532/NAD-29827 PISTON BOTTOM Order No. WC1-358-1619</p>
<p>APPLICATIONS: Holland (Neway) 90557142</p>		

BELLOWS 1T15M7.5	AON W01-358-9943	C01-358-2197 15.16 Composite
<p>CROSS SECTION</p>	<p>3249 BEAD PLATE TOP</p>	<p>9540/NAD-29828 PISTON BOTTOM Order No. WC1-358-0664</p>
<p>APPLICATIONS: Holland (Neway) 90557143</p> <p style="color: red; font-weight: bold;">OBSOLETE: NO LONGER AVAILABLE</p>		

BELLOWS 1T15M7.5	AON W01-358-9947	C01-358-2197 15.88 Composite
<p>CROSS SECTION</p>	<p>3254 BEAD PLATE TOP</p>	<p>9544/NAD-29826 PISTON BOTTOM Order No. WC1-358-0666</p>
<p>APPLICATIONS: Reyco 20142-01 & 01K</p>		

BELLOWS 1T15M7.5	AON W01-358-9971	C01-358-2197 84.68 Aluminum
<p>CROSS SECTION</p>	<p>3235 BEAD PLATE TOP</p>	<p>9652/NBD-10486 PISTON BOTTOM ORDER NO. WC1-358-0659</p>
<p>APPLICATIONS: Holland (Neway) 90557295 (RL230,GRL228)</p>		

HARDWARE KEY

- Bolt or Stud 1/2-13
- ⊗ Air Inlet 1/4 N.P.T.
- ⊗ Combination Stud/Air Inlet Stud Outside Thread is 3/4-16 Pistons
- ⊗ Exception to Standard Stud/Air Inlet Stud Inside Thread of 1/4 N.P.T.

- ▲ No Alignment Specified-Center Stud Mounting is Standard
- ⊗ Threaded Hole 3/8-16 Blind Nut on Bead Plates 1/2-13 Pistons

BELLOWS 1T15M75	AON W01-358-9974	C01-358-2197 14.34 Aluminum
<p>CROSS SECTION</p>	<p>BEAD PLATE TOP</p>	<p>PISTON BOTTOM</p> <p>ORDER NO. WC1-358-0659</p> <p>APPLICATIONS: Holland 90557332</p>
BELLOWS 1T15M8	AON W01-358-9287	C01-358-2160 18.50 Composite
<p>CROSS SECTION</p>	<p>BEAD PLATE TOP</p>	<p>PISTON BOTTOM</p> <p>Order No. WC1-358-1606</p> <p>BRACKET WC1-358-3903</p> <p>APPLICATIONS: Hendrickson 50405-1&2 (Ford, W.Star) HA-360/400/460 [1991-Up] Hendrickson 50405 (remove intermediate plate and use new production version with bracket)</p>
BELLOWS 1T15M8	AON W01-358-9297	C01-358-2160 16.48 Composite
<p>CROSS SECTION</p>	<p>BEAD PLATE TOP</p>	<p>PISTON BOTTOM</p> <p>Order No. WC1-358-1628</p> <p>BRACKET WC1-358-3903</p> <p>APPLICATIONS: Hendrickson 50898-1 & 2 (GH & Ford) (class 6, 7 & 8) Hendrickson Truck 64651-2</p>
BELLOWS 1T15M8	AON W01-358-9371	C01-358-2160 17.96 Composite
<p>CROSS SECTION</p>	<p>BEAD PLATE TOP</p>	<p>PISTON BOTTOM</p> <p>ORDER NO. WC1-358-1620</p> <p>BRACKET WC1-358-3888</p> <p>APPLICATIONS: Navistar 1670073C-1 Navistar 1686386C-1</p>
BELLOWS 1T15M8	AON W01-358-9373	C01-358-2160 16.05 Composite
<p>CROSS SECTION</p>	<p>BEAD PLATE TOP</p>	<p>PISTON BOTTOM</p> <p>Order No. WC1-358-1628</p> <p>BRACKET WC1-358-3903</p> <p>APPLICATIONS: Hendrickson 57122-2 (Ford, class 8) HAS-360/400/402/460</p>

<p>BELLOWS 1T15M8</p> <p>CROSS SECTION</p>	<p>AON W01-358-9375</p> <p>3313 9.00 6.20 4.59 5.98 2.55</p> <p>9538 / NAD-27740 10.00</p> <p>ORDER NO. WC1-358-1628</p>	<p>C01-358-2160 16.88 Composite</p> <p>BRACKET WC1-358-3904</p> <p>APPLICATIONS: Hendrickson 50899 -1 & 2 (Mack-class 8) 57QL414M Mack 3645Q27</p>
<p>BELLOWS 1T15M8</p> <p>CROSS SECTION</p>	<p>AON W01-358-9641</p> <p>3004 9.00 6.20 4.59 5.98 2.55</p> <p>9538/NAD-27740 10.00</p> <p>Order No. WC1-358-1628</p>	<p>C01-358-2160 16.75 Composite</p> <p>APPLICATIONS: Hendrickson 59010-2</p>
<p>BELLOWS 1T15M8</p> <p>CROSS SECTION</p>	<p>AON W01-358-9647</p> <p>3512 9.00 5.69 4.49 0.88 2.50</p> <p>9538/NAD-27740 10.00</p> <p>Order No. WC1-358-1628</p>	<p>C01-358-2160 15.86 Composite</p> <p>BRACKET WC1-358-3906</p> <p>APPLICATIONS: Hendrickson 58786-2 (MACK 57QL417M)</p> <p>REPLACES 1T15MT8</p>
<p>BELLOWS 1T15M8</p> <p>CROSS SECTION</p>	<p>AON W01-358-9649</p> <p>3235 9.00 5.50</p> <p>9561 / NAD-32767 10.00 4.50</p> <p>ORDER NO. WC1-358-1606</p>	<p>C01-358-2160 17.22 Composite</p> <p>APPLICATIONS: Holland (Neway) 90557252</p>
<p>BELLOWS 1T15M8</p> <p>CROSS SECTION</p>	<p>AON W01-358-9654</p> <p>3275 9.00 5.87</p> <p>9538/NAD-27740 10.30 6.75 1/2-13 UNC-2A</p> <p>Order No. WC1-358-1628 Order No. WC1-358-3715</p>	<p>C01-358-2160 15.10 Composite</p> <p>APPLICATIONS: Hendrickson 65032-2 Mack 57QL53M</p>

HARDWARE KEY

- Bolt or Stud 1/2-13
- ⊗ Air Inlet 1/4 N.P.T.
- ⊗ Combination Stud/Air Inlet Stud Outside Thread is 3/4-16 Pistons
- ⊗ Exception to Standard Stud/Air Inlet Stud Inside Thread of 1/4 N.P.T.

▲ No Alignment Specified-Center Stud Mounting is Standard
⊗ Threaded Hole 3/8-16 Blind Nut on Bead Plates 1/2-13 Pistons

BELLOWS 1T15M8	AON W01-358-9663	C01-358-2160 16.23 Composite
<p>CROSS SECTION</p>	<p>BEAD PLATE TOP</p>	BRACKET WC1-358-3906 APPLICATIONS: Hendrickson Truck 60271-2 Mack 57WL57M
BELLOWS 1T15M8	AON W01-M58-9372	C01-M58-2123 16.74 Composite
<p>CROSS SECTION</p>	<p>BEAD PLATE TOP</p>	APPLICATIONS: Hendrickson 58520-2 (Nissan) (replaces 58654-2) Hendrickson Truck 64489-2
BELLOWS 1T15M8	AON W01-M58-9656	C01-M58-2123 19.00 Composite
<p>CROSS SECTION</p>	<p>BEAD PLATE TOP</p>	APPLICATIONS: Hendrickson Truck 64651-2 Mack 57QL57M
BELLOWS 1T15M9	AON W01-358-0783	C01-358-1000 27.50 Composite
<p>CROSS SECTION</p>	<p>BEAD PLATE TOP</p>	APPLICATIONS: Goodyear 1R12-467 Ridewell 1000001
BELLOWS 1T15M9	AON W01-358-8842	C01-358-1000 15.21 Composite
<p>CROSS SECTION</p>	<p>BEAD PLATE TOP</p>	APPLICATIONS: Link 1103-0058

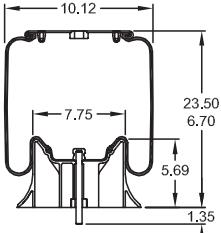
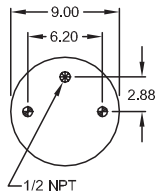
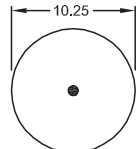
BELLOWS 1T15M9	AON W01-358-8852	 <p>CROSS SECTION</p>	<p>3302</p>  <p>BEAD PLATE TOP</p>	<p>9532/NAD-29827</p>  <p>PISTON BOTTOM</p> <p>ORDER NO. WC1-358-1619</p>	<p>C01-358-1000 13.19 Composite</p> <hr/> <p>APPLICATIONS: Peterbilt 03-07887 (Low Air Leaf)</p>
-----------------------	-------------------------	--	---	--	--

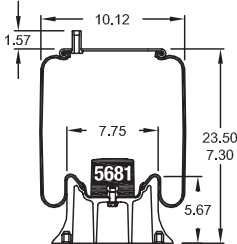
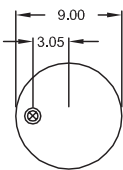
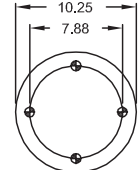
BELLOWS 1T15M9	AON W01-358-8855	 <p>CROSS SECTION</p>	<p>3242</p>  <p>BEAD PLATE TOP</p>	<p>9530/ NAD-27809</p>  <p>PISTON BOTTOM</p> <p>ORDER NO. WC1-358-9452</p>	<p>C01-358-1000 14.64 Composite</p> <hr/> <p>APPLICATIONS: Reyco 23521-01</p>
-----------------------	-------------------------	--	---	---	---

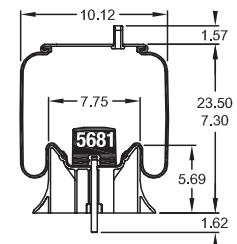
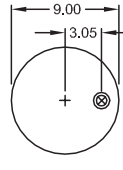
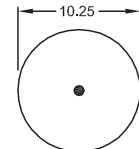
BELLOWS 1T15M9	AON W01-358-8856	 <p>CROSS SECTION</p>	<p>3242</p>  <p>BEAD PLATE TOP</p>	<p>9532/NAD-29827</p>  <p>PISTON BOTTOM</p> <p>Order No. WC1-358-1619</p>	<p>C01-358-1000 14.53 Composite</p> <hr/> <p>APPLICATIONS: Reyco 23521-02</p>
-----------------------	-------------------------	---	--	---	---

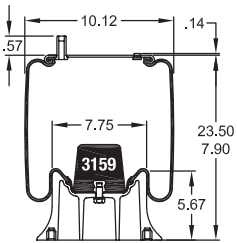
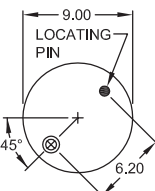
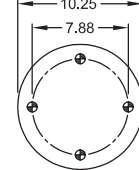
BELLOWS 1T15M9	AON W01-358-8861	 <p>CROSS SECTION</p>	<p>3192</p>  <p>BEAD PLATE TOP</p>	<p>9530/NAD-27809</p>  <p>PISTON BOTTOM</p> <p>Order No. WC1-358-9452</p>	<p>C01-358-1000 15.46 Composite</p> <hr/> <p>APPLICATIONS: Watson & Chalin AS-0061-1 Goodyear 1R12-534</p>
-----------------------	-------------------------	--	---	--	--

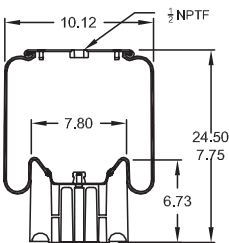
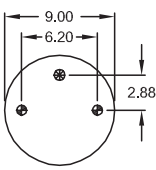
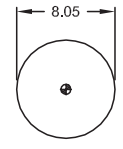
BELLOWS 1T15M9	AON W01-358-8864	 <p>CROSS SECTION</p>	<p>3202</p>  <p>BEAD PLATE TOP</p>	<p>9531 / NAD-28197</p>  <p>PISTON BOTTOM</p> <p>ORDER NO. WC1-358-1626</p>	<p>C01-358-1000 14.06 Composite</p> <hr/> <p>APPLICATIONS: Peterbilt 03-08716 (New Low Leaf Supersedes 03-07887 effective 04/04) C811011 Paccar Part</p>
-----------------------	-------------------------	--	---	--	--

HARDWARE KEY

- Bolt or Stud 1/2-13
- ⊗ Air Inlet 1/4 N.P.T.
- ⊗ Combination Stud/Air Inlet Stud Outside Thread is 3/4-16 Pistons
- ⊗ Exception to Standard Stud/Air Inlet Stud Inside Thread of 1/4 N.P.T.

- ▲ No Alignment Specified-Center Stud Mounting is Standard
- ⊗ Threaded Hole 3/8-16 Blind Nut on Bead Plates 1/2-13 Pistons

BELLOWS 1T15M9	AON W01-358-9101	🚚 C01-358-1000 📦 16.65 🏠 Composite
<p style="text-align: center; font-size: small;">CROSS SECTION</p>	<p style="text-align: center; font-size: small;">BEAD PLATE TOP</p>	<p style="text-align: center; font-size: small;">PISTON BOTTOM</p> <p style="text-align: center; font-size: small;">ORDER NO. WC1-358-9453</p>
SERVICE ASSEMBLY W01-358-9102		<p>APPLICATIONS: Holland (Neway) 90557008, 90557009, 90557082 Ridewell 1003589101C Reyco 12883-01 Silent Drive Truckstell (Marion Mfg.) 63647 MFG.SV.# Neway 90044201 Watson & Chalin AS-0040</p>

BELLOWS 1T15M9	AON W01-358-9106	🚚 C01-358-1000 📦 17.98 🏠 Aluminum
<p style="text-align: center; font-size: small;">CROSS SECTION</p>	<p style="text-align: center; font-size: small;">BEAD PLATE TOP</p>	<p style="text-align: center; font-size: small;">PISTON BOTTOM</p> <p style="text-align: center; font-size: small;">Order No. WC1-358-0620</p>
SERVICE ASSEMBLY W01-358-9102		<p>APPLICATIONS:</p>

BELLOWS 1T15M9	AON W01-358-9130	🚚 C01-358-1000 📦 16.31 🏠 Composite
<p style="text-align: center; font-size: small;">CROSS SECTION</p>	<p style="text-align: center; font-size: small;">BEAD PLATE TOP</p>	<p style="text-align: center; font-size: small;">PISTON BOTTOM</p> <p style="text-align: center; font-size: small;">Order No. WC1-358-9453</p>
SERVICE ASSEMBLY W01-358-9102		<p>APPLICATIONS:</p>

BELLOWS 1T15M9	AON W01-358-9192	🚚 C01-358-1000 📦 15.87 🏠 Composite
<p style="text-align: center; font-size: small;">CROSS SECTION</p>	<p style="text-align: center; font-size: small;">BEAD PLATE TOP</p>	<p style="text-align: center; font-size: small;">PISTON BOTTOM</p> <p style="text-align: center; font-size: small;">Order No. WC1-358-9452</p>
SERVICE ASSEMBLY W01-358-9102		<p>APPLICATIONS: Hendrickson Trailer S6195 Holland (Neway) 90557086 90557108 (AR-90) Watson & Chalin AS-0038 AS-0046 Rotate Piston 90557135-28LH Rotate Piston 90557136-28RH</p>

BELLOWS 1T15M9	AON W01-358-9203	🚚 C01-358-1000 📦 15.98 🏠 Composite
<p style="text-align: center; font-size: small;">CROSS SECTION</p>	<p style="text-align: center; font-size: small;">BEAD PLATE TOP</p>	<p style="text-align: center; font-size: small;">PISTON BOTTOM</p> <p style="text-align: center; font-size: small;">Order No. WC1-358-9452</p>
SERVICE ASSEMBLY W01-358-9102		<p>APPLICATIONS: Hendrickson Trailer S2694</p>

<p>BELLOWS 1T15M9</p>	<p>AON W01-358-9238</p>	<p>C01-358-1000 16.38 Composite</p>
<p>CROSS SECTION</p>	<p>BEAD PLATE TOP</p>	<p>9553/NAD-29467</p> <p>PISTON BOTTOM</p> <p>Order No. WC1-358-9453</p> <p>APPLICATIONS: Hendrickson Trailer S5060</p>
<p>BELLOWS 1T15M9</p>	<p>AON W01-358-9240</p>	<p>C01-358-1000 16.63 Composite</p>
<p>CROSS SECTION</p>	<p>BEAD PLATE TOP</p>	<p>9553 / NAD-29467</p> <p>PISTON BOTTOM</p> <p>ORDER NO. WC1-358-9453</p> <p>APPLICATIONS: Hendrickson Trailer S3842 Hendrickson Can. S10352</p> <p>OBSOLETE: NO LONGER AVAILABLE</p>
<p>BELLOWS 1T15M9</p>	<p>AON W01-358-9241</p>	<p>C01-358-1000 16.17 Composite</p>
<p>CROSS SECTION</p>	<p>BEAD PLATE TOP</p>	<p>9553/NAD-29467</p> <p>PISTON BOTTOM</p> <p>Order No. WC1-358-9453</p> <p>APPLICATIONS:</p>
<p>BELLOWS 1T15M9</p>	<p>AON W01-358-9243</p>	<p>C01-358-1000 14.44 Composite</p>
<p>CROSS SECTION</p>	<p>BEAD PLATE TOP</p>	<p>9532 / NAD-29827</p> <p>PISTON BOTTOM</p> <p>ORDER NO. WC1-358-1619</p> <p>APPLICATIONS: Holland (Neway) 900557112 (AR90-[All]) (ARU92-9&10) Watson & Chalin AS-0061</p>
<p>BELLOWS 1T15M9</p>	<p>AON W01-358-9245</p>	<p>C01-358-1000 15.80 Composite</p>
<p>CROSS SECTION</p>	<p>BEAD PLATE TOP</p>	<p>9530 / NAD-27809</p> <p>PISTON BOTTOM</p> <p>Order No. WC1-358-9452</p> <p>SERVICE ASSEMBLY W01-358-9102</p> <p>APPLICATIONS: Ridewell 1003589245C</p>

HARDWARE KEY

- Bolt or Stud 1/2-13
- ⊗ Air Inlet 1/4 N.P.T.
- ⊗ Combination Stud/Air Inlet Stud Outside Thread is 3/4-16 Pistons
- ⊗ Exception to Standard Stud/Air Inlet Stud Inside Thread of 1/4 N.P.T.

- ▲ No Alignment Specified-Center Stud Mounting is Standard
- ⊗ Threaded Hole 3/8-16 Blind Nut on Bead Plates 1/2-13 Pistons

<p>BELLOWS 1T15M9</p>	<p>AON W01-358-9346</p>	<p>C01-358-1000 16.60 Composite</p>	
<p>CROSS SECTION</p>	<p>3235</p> <p>BEAD PLATE TOP</p>	<p>9540/NAD-29828</p> <p>Order No. WC1-358-0664</p> <p>PISTON BOTTOM</p>	<p>SERVICE ASSEMBLY W01-358-9102</p> <p>APPLICATIONS: Holland (Neway) 90557126 (AR-75-12) (AR-75-1-12) (ARU92-12) Watson & Chalin AS-0056</p>
<p>BELLOWS 1T15M9</p>	<p>AON W01-358-9348</p>	<p>C01-358-1000 16.87 Composite</p>	
<p>CROSS SECTION</p>	<p>3173</p> <p>BEAD PLATE TOP</p>	<p>9553/NAD-29467</p> <p>Order No. WC1-358-9453</p> <p>PISTON BOTTOM</p>	<p>APPLICATIONS: CCG McCullough Trailer</p> <p>OBSOLETE: NO LONGER AVAILABLE</p>
<p>BELLOWS 1T15M9</p>	<p>AON W01-358-9350</p>	<p>C01-358-1000 14.60 Composite</p>	
<p>CROSS SECTION</p>	<p>3271</p> <p>BEAD PLATE TOP</p>	<p>9553/NAD-29467</p> <p>Order No. WC1-358-9453</p> <p>PISTON BOTTOM</p>	<p>APPLICATIONS: Watson & Chalin</p>
<p>BELLOWS 1T15M9</p>	<p>AON W01-358-9394</p>	<p>C01-358-1000 16.50 Composite</p>	
<p>CROSS SECTION</p>	<p>3271</p> <p>BEAD PLATE TOP</p>	<p>9553/NAD-29467</p> <p>Order No. WC1-358-9453</p> <p>PISTON BOTTOM</p>	<p>APPLICATIONS: Fruehauf UCD-9393-2 (if bolt is removed, this part can replace the UCE-9393-1) Suspensions Inc. 200041 Supersedes 9241</p>
<p>BELLOWS 1T15M11</p>	<p>AON W01-358-9320</p>	<p>C01-358-5129 17.33 Composite</p>	
<p>CROSS SECTION</p>	<p>3490</p> <p>BEAD PLATE TOP</p>	<p>9553/NAD-29467</p> <p>Order No. WC1-358-9453</p> <p>PISTON BOTTOM</p>	<p>APPLICATIONS: Holland (Neway) 90557099 Silent Drive</p>

BELLOWS 1T15M11	AON W01-358-9321	C01-358-5129 19.76 Aluminum
 CROSS SECTION	3271 BEAD PLATE TOP	9653/NBD-10437 PISTON BOTTOM Order No. WC1-358-0620
APPLICATIONS: Watson & Chalin AS-0036		

BELLOWS 1T15M11	AON W01-358-9367	C01-358-5129 20.41 Aluminum
 CROSS SECTION	3188 BEAD PLATE TOP	9653/NBD-10437 PISTON BOTTOM Order No. WC1-358-0620
APPLICATIONS: Hendrickson S14249 (W01-455-9321) Hendrickson Aux. 003319 (metric equivalent)		

BELLOWS 1T15M11	AON W01-358-9368	C01-358-5129 20.71 Composite
 CROSS SECTION	3205 BEAD PLATE TOP	9553/NAD-29467 PISTON BOTTOM Order No. WC1-358-9453
APPLICATIONS: Ridewell 1003589368C OBSELETE: NO LONGER AVAILABLE		

BELLOWS 1T15M11	AON W01-358-9370	C01-358-5129 16.96 Composite
 CROSS SECTION	3188 BEAD PLATE TOP	9540/NAD-29828 PISTON BOTTOM Order No. WC1-358-0664
APPLICATIONS: Watson & Chalin AS-0057		

BELLOWS 1T15MA4	AON W01-M58-9851	C01-M58-2292 13.00 Composite
 CROSS SECTION	3313 BEAD PLATE TOP	9573/NAD-18162 PISTON BOTTOM Order No. WC1-358-1634
APPLICATIONS: Hendrickson 65086-2		

- HARDWARE KEY**
- Bolt or Stud 1/2-13
 - ⊗ Air Inlet 1/4 N.P.T.
 - ⊙ Combination Stud/Air Inlet Stud Outside Thread is 3/4-16 Pistons
 - ⊕ Exception to Standard Stud/Air Inlet Stud Inside Thread of 1/4 N.P.T.

- ▲ No Alignment Specified-Center Stud Mounting is Standard
- ⊕ Threaded Hole 3/8-16 Blind Nut on Bead Plates 1/2-13 Pistons

BELLOWS 1T15MBTW6	AON W01-358-9644	C01-358-1081 13.84 Composite
<p>CROSS SECTION</p>	<p>BEAD PLATE TOP</p>	<p>PISTON BOTTOM</p> <p>Order No. WC1-358-1619</p> <p>APPLICATIONS: Hendrickson Trailer S23721</p>
BELLOWS 1T15MBTW10	AON W01-358-9646	C01-358-1078 14.43 Composite
<p>CROSS SECTION</p>	<p>BEAD PLATE TOP</p>	<p>PISTON BOTTOM</p> <p>Order No. WC1-358-1619</p> <p>APPLICATIONS: Hendrickson Trailer S23611</p>
BELLOWS 1T15MBTW12	AON W01-358-9645	C01-358-1079 16.93 Composite
<p>CROSS SECTION</p>	<p>BEAD PLATE TOP</p>	<p>PISTON BOTTOM</p> <p>Order No. WC1-358-0664</p> <p>APPLICATIONS: Hendrickson Trailer S23612</p>
BELLOWS 1T15MLW7	AON W01-358-8944	C01-358-0007 16.70 Aluminum
<p>CROSS SECTION</p>	<p>BEAD PLATE TOP</p>	<p>PISTON BOTTOM</p> <p>Order No. WC1-358-1694</p> <p>APPLICATIONS: Hendrickson Trailer S20217 (HT-190U)</p> <p>REPLACES W01-358-9015</p>
BELLOWS 1T15MM9	AON W01-358-9265	C01-358-2203 16.68 Aluminum
<p>CROSS SECTION</p>	<p>BEAD PLATE TOP</p>	<p>PISTON BOTTOM</p> <p>Order No. WC1-358-1694</p> <p>APPLICATIONS: Hendrickson Trailer S20124 Hendrickson Trailer HT-250T Hendrickson Trailer C20413 (rotate piston to 45deg alignment) Hendrickson Trailer HT-250U (all others) Hendrickson Trailer HT-250U-Y (9Y-001)</p> <p>REPLACES 1T15MW10</p>

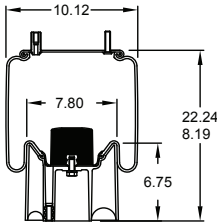
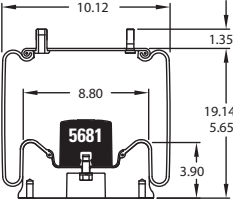
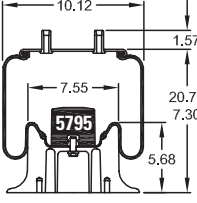
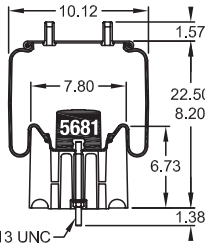
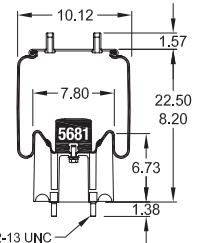
<p>BELLOWS 1T15MMW8.0</p>  <p>CROSS SECTION</p>	<p>AON W01-M58-7074</p> <p>3532 9.00 6.25 M22x1.5, M12x1.5</p> <p>3881/NAD-34837 8.00 4.00 2x M12x1.75</p> <p>BEAD PLATE TOP</p> <p>PISTON BOTTOM</p>	<p>C01-M58-0032 13.12 Composite</p> <p>APPLICATIONS:</p>
<p>BELLOWS 1T15MN6</p>  <p>CROSS SECTION</p>	<p>AON W01-358-8828</p> <p>3191 9.00 6.20</p> <p>9603/NAD-29630 9.50 7.88</p> <p>Order No. WC1-358-1635</p> <p>BEAD PLATE TOP</p> <p>PISTON BOTTOM</p>	<p>C01-358-2200 15.37 Aluminum</p> <p>APPLICATIONS:</p>
<p>BELLOWS 1T15MPW6</p>  <p>CROSS SECTION</p>	<p>AON W01-358-8494</p> <p>3226 9.00 5.50 .500 PIN</p> <p>9532/NAD-29827 10.25</p> <p>Order No. WC1-358-1619</p> <p>BEAD PLATE TOP</p> <p>PISTON BOTTOM</p>	<p>C01-358-0082 14.07 Composite</p> <p>APPLICATIONS:</p>
<p>BELLOWS 1T15MPW7</p>  <p>CROSS SECTION</p>	<p>AON W01-358-6231</p> <p>3249 9.00 4.75 1.50</p> <p>9507/NAD-31763 8.05</p> <p>BEAD PLATE TOP</p> <p>PISTON BOTTOM</p>	<p>C01-358-0054 14.54 Composite</p> <p>APPLICATIONS: Arvin Meritor 21227742FS FS230</p> <p>REPLACES W01-358-6262</p>
<p>BELLOWS 1T15MPW7</p>  <p>CROSS SECTION</p>	<p>AON W01-358-6262</p> <p>3249 9.00 4.75 1.50</p> <p>9557/NAD-31181 8.05 3.94</p> <p>Order No. WC1-358-1654</p> <p>BEAD PLATE TOP</p> <p>PISTON BOTTOM</p>	<p>C01-358-0054 14.34 Composite</p> <p>APPLICATIONS:</p>

HARDWARE KEY

- Bolt or Stud 1/2-13
- ⊗ Air Inlet 1/4 N.P.T.
- ⊗ Combination Stud/Air Inlet Stud Outside Thread is 3/4-16 Pistons
- ⊗ Exception to Standard Stud/Air Inlet Stud Inside Thread of 1/4 N.P.T.

- ▲ No Alignment Specified-Center Stud Mounting is Standard
- ⊗ Threaded Hole 3/8-16 Blind Nut on Bead Plates 1/2-13 Pistons

<p>BELLOWS 1T15MPW7</p>	<p>AON W01-358-8903</p>	<p>C01-M58-0032 13.64 Composite</p>
<p>CROSS SECTION</p>	<p>BEAD PLATE TOP</p>	<p>PISTON BOTTOM</p> <p>Order No. WC1-358-1619</p>
<p>BELLOWS 1T15MR2</p>	<p>AON W01-358-9268</p>	<p>C01-358-1016 9.07 No Piston</p>
<p>CROSS SECTION</p>	<p>BEAD PLATE TOP</p>	<p>PISTON BOTTOM</p>
<p>BELLOWS 1T15MT3</p>	<p>AON W01-358-8466</p>	<p>C01-358-1069 16.37 Composite</p>
<p>CROSS SECTION</p>	<p>BEAD PLATE TOP</p>	<p>PISTON BOTTOM</p> <p>ORDER NO. WC1-358-1652</p>
<p>BELLOWS 1T15MT3</p>	<p>AON W01-358-9634</p>	<p>C01-358-1069 16.19 Composite</p>
<p>CROSS SECTION</p>	<p>BEAD PLATE TOP</p>	<p>PISTON BOTTOM</p> <p>Order No. WC1-358-1652</p> <p>APPLICATIONS: Freightliner 16-14263-000 Freightliner 16-15443-000 (6033 bracket) Freightliner 16-14263-001 Freightliner 16-15443-001 (6034 bracket) Freightliner 16-15444-000 service (no bracket, no piston) - reuse old bracket or purchase separately replacement Freightliner 16-19470-000, 16-18333-000, 16-18333-001</p> <p>REPLACES 1T15ZR3</p>
<p>BELLOWS 1T15MT3</p>	<p>AON W01-358-9640</p>	<p>C01-358-1069 14.27 Aluminum</p>
<p>CROSS SECTION</p>	<p>BEAD PLATE TOP</p>	<p>PISTON BOTTOM</p> <p>ORDER NO. WC1-358-1608</p> <p>APPLICATIONS: Hendrickson Trailer S20223 (HT-190T, HS-190T)</p> <p>REPLACES W01-358-9630</p>

<p>BELLOWS 1T15MT6</p> <p>CROSS SECTION</p>	<p>AON W01-358-8831</p> <p>3271</p> <p>BEAD PLATE TOP</p> <p>9561 / NAD-32767</p> <p>PISTON BOTTOM</p> <p>ORDER NO. WC1-358-1606</p>	<p>C01-358-2169 14.69 Composite</p> <p>APPLICATIONS:</p>
<p>BELLOWS 1T15MT6</p> <p>CROSS SECTION</p>	<p>AON W01-358-9643</p> <p>3313</p> <p>BEAD PLATE TOP</p> <p>9538 / NAD-27740</p> <p>PISTON BOTTOM</p> <p>ORDER NO. WC1-358-1628</p>	<p>C01-358-2169 15.93 Composite</p> <p>BRACKET WC1-358-3903</p> <p>APPLICATIONS: Hendrickson 58995-2 (Freightliner)</p> <p>OBSELETE: NO LONGER AVAILABLE</p>
<p>BELLOWS 1T15MW6</p> <p>CROSS SECTION</p>	<p>AON W01-358-9299</p> <p>3242</p> <p>BEAD PLATE TOP</p> <p>9694/NAD-25396</p> <p>PISTON BOTTOM</p> <p>Order No. WC1-358-1694</p>	<p>C01-358-2205 16.41 Aluminum</p> <p>APPLICATIONS: Hendrickson Trailer S20716 [HT250U(6.5-002)]</p>
<p>BELLOWS 1T15SN6</p> <p>CROSS SECTION</p>	<p>AON W01-358-9260</p> <p>3201</p> <p>BEAD PLATE TOP</p> <p>9535/NAD-29592</p> <p>PISTON BOTTOM</p> <p>Order No. N/A</p>	<p>C01-358-2161 13.20 Composite</p> <p>APPLICATIONS: Jet Co. (10.3 max. OD) Bolt removed for center mounting</p>
<p>BELLOWS 1T15SN6</p> <p>CROSS SECTION</p>	<p>AON W01-358-9278</p> <p>3225</p> <p>BEAD PLATE TOP</p> <p>9535/NAD-29592</p> <p>PISTON BOTTOM</p>	<p>C01-358-2161 11.43 Composite</p> <p>APPLICATIONS: Caterpillar 102-9283</p> <p>OBSELETE: NO LONGER AVAILABLE</p>

HARDWARE KEY

- Bolt or Stud 1/2-13
- ⊗ Air Inlet 1/4 N.P.T.
- ⊙ Combination Stud/Air Inlet Stud Outside Thread is 3/4-16 Pistons
- ⊕ Exception to Standard Stud/Air Inlet Stud Inside Thread of 1/4 N.P.T.

- ▲ No Alignment Specified-Center Stud Mounting is Standard
- ⊕ Threaded Hole 3/8-16 Blind Nut on Bead Plates 1/2-13 Pistons

<p>BELLOWS 1T15T1</p>	<p>AON W01-358-9401</p>	<p>C01-358-1013 9.70 Composite</p>
<p>CROSS SECTION</p>	<p>3201</p> <p>BEAD PLATE TOP</p>	<p>9492 / FIP-100742</p> <p>PISTON BOTTOM</p> <p>APPLICATIONS:</p>
<p>BELLOWS 1T15T1</p>	<p>AON W01-358-9402</p>	<p>C01-358-1013 10.64 Composite</p>
<p>CROSS SECTION</p>	<p>3215</p> <p>BEAD PLATE TOP</p>	<p>9492 / FIP-100742</p> <p>PISTON BOTTOM</p> <p>Order No. WC1-358-1642</p> <p>APPLICATIONS: Capacity of Texas</p>
<p>BELLOWS 1T15T1</p>	<p>AON W01-358-9650</p>	<p>C01-358-1013 12.26 Aluminum</p>
<p>CROSS SECTION</p>	<p>3235</p> <p>BEAD PLATE TOP</p>	<p>9654/NBD-10438</p> <p>PISTON BOTTOM</p> <p>Order No. WC1-358-0663</p> <p>APPLICATIONS: Holland (Neway) 90557097</p>
<p>BELLOWS 1T15T1</p>	<p>AON W01-358-9651</p>	<p>C01-358-1013 9.83 Composite</p>
<p>CROSS SECTION</p>	<p>3220</p> <p>BEAD PLATE TOP</p>	<p>9571/NAD-18130</p> <p>PISTON BOTTOM</p> <p>Order No. WC1-358-0646</p> <p>APPLICATIONS: Monaco Coach 01806160</p>
<p>BELLOWS 1T15TM1</p>	<p>AON W01-358-5766</p>	<p>C01-358-1008 12.17 Composite</p>
<p>CROSS SECTION</p>	<p>3235</p> <p>BEAD PLATE TOP</p>	<p>9492/FIP-100742</p> <p>PISTON BOTTOM</p> <p>Order No. WC1-358-1642</p> <p>APPLICATIONS: American Carrier 8003-023 Hutchens 19141-01</p>

<p>BELLOWS 1T15TM1</p>	<p>AON W01-358-9421</p>	<p>C01-358-1008 10.07 Composite</p>
<p>CROSS SECTION</p>	<p>3235</p> <p>BEAD PLATE TOP</p> <p>9492/FIP-100742</p> <p>PISTON BOTTOM</p> <p>Order No. WC1-358-1642</p>	<p>APPLICATIONS: American Carrier 8003-003</p>
<p>BELLOWS 1T15TM1</p>	<p>AON W01-358-9423</p>	<p>C01-358-1008 13.04 Aluminum</p>
<p>CROSS SECTION</p>	<p>3235</p> <p>BEAD PLATE TOP</p> <p>9655/NBD-10439</p> <p>PISTON BOTTOM</p> <p>Order No. WC1-358-9454</p>	<p>APPLICATIONS: Ridewell 1003589423C</p> <p>OBSELETE: NO LONGER AVAILABLE</p>
<p>BELLOWS 1T15TQ1</p>	<p>AON W01-358-5770</p>	<p>C01-358-1030 11.17 Aluminum</p>
<p>CROSS SECTION</p>	<p>3235</p> <p>BEAD PLATE TOP</p> <p>9681/NBD-14213</p> <p>PISTON BOTTOM</p> <p>Order No. WC1-358-1612</p>	<p>APPLICATIONS: Ridewell 1003585770C Watson & Chalin AS-0042</p>
<p>BELLOWS 1T15TQ1</p>	<p>AON W01-358-5772</p>	<p>C01-358-1031 9.42 Aluminum</p>
<p>CROSS SECTION</p>	<p>3235</p> <p>BEAD PLATE TOP</p> <p>9681/NBD-14213</p> <p>PISTON BOTTOM</p> <p>Order No. WC1-358-1612</p>	<p>APPLICATIONS: Brock Link (see 5789)</p>
<p>BELLOWS 1T15TQ1</p>	<p>AON W01-358-5775</p>	<p>C01-358-1031 11.94 Aluminum</p>
<p>CROSS SECTION</p>	<p>3211</p> <p>BEAD PLATE TOP</p> <p>9681/NBD-14213</p> <p>PISTON BOTTOM</p> <p>Order No. WC1-358-1612</p>	<p>APPLICATIONS: Reyco 20783-01</p>

HARDWARE KEY

- Bolt or Stud 1/2-13
- ⊗ Air Inlet 1/4 N.P.T.
- ⊗ Combination Stud/Air Inlet Stud Outside Thread is 3/4-16 Pistons
- ⊗ Exception to Standard Stud/Air Inlet Stud Inside Thread of 1/4 N.P.T.

- ▲ No Alignment Specified-Center Stud Mounting is Standard
- ⊗ Threaded Hole 3/8-16 Blind Nut on Bead Plates 1/2-13 Pistons

<p>BELLOWS 1T15TQ1</p>	<p>AON W01-358-5776</p>	<p>C01-358-1048 11.64 Aluminum</p>
<p>CROSS SECTION</p>	<p>BEAD PLATE TOP</p>	<p>9681/NBD-14213 8.00 3/4-10 UNC Order No. WC1-358-1612</p> <p>BRACKET WC1-358-3887</p> <p>APPLICATIONS: Holland (Neway) 90557174 (AS 120) ref. W01-358-9586 (1/2 NPT)</p>
<p>BELLOWS 1T15TQ1</p>	<p>AON W01-358-5777</p>	<p>C01-358-1031 11.01 Aluminum</p>
<p>CROSS SECTION</p>	<p>BEAD PLATE TOP</p>	<p>9681/NBD-14213 8.00 Order No. WC1-358-1612</p> <p>APPLICATIONS: Reyco 22425-01</p>
<p>BELLOWS 1T15TQ1</p>	<p>AON W01-358-5783</p>	<p>C01-358-1030 10.52 Aluminum</p>
<p>CROSS SECTION</p>	<p>BEAD PLATE TOP</p>	<p>4078/NBD-17119 8.00</p> <p>APPLICATIONS:</p>
<p>BELLOWS 1T15TQ1</p>	<p>AON W01-358-5789</p>	<p>C01-358-1031 11.17 Aluminum</p>
<p>CROSS SECTION</p>	<p>BEAD PLATE TOP</p>	<p>9681/NBD-14213 8.00 Order No. WC1-358-1612</p> <p>APPLICATIONS: Link 1103-0503 Ultraride</p>
<p>BELLOWS 1T15TQ1</p>	<p>AON W01-358-5792</p>	<p>C01-358-1030 11.61 Composite</p>
<p>CROSS SECTION</p>	<p>BEAD PLATE TOP</p>	<p>9492/FIP-100742 9.25 Order No. WC1-358-1642</p> <p>APPLICATIONS: Ridewell 1003585792C</p>

BELLOWS 1T15TQ1	AON W01-358-9586	C01-358-1048 11.78 Aluminum
<p>CROSS SECTION</p>	<p>BEAD PLATE TOP</p>	<p>9681/NBD-14213</p> <p>PISTON BOTTOM</p> <p>Order No. WC1-358-1612</p>
		<p>BRACKET WC1-358-3887</p> <p>APPLICATIONS: Holland (Neway) 90557249 Replaces 90557221 (1/2 NPT-flush) (ref.W01-358-5776)</p>

BELLOWS 1T15V1	AON W01-358-9249	C01-358-5103 12.16 Composite
<p>CROSS SECTION</p>	<p>BEAD PLATE TOP</p>	<p>9528/NBD-14404</p> <p>PISTON BOTTOM</p> <p>Order No. WC1-358-0667</p>
		<p>APPLICATIONS: Holland (Neway) 90557107 Mercedes Bus Mexico Front</p>

BELLOWS 1T15V3	AON W01-358-9578	C01-358-5098 11.57 Composite
<p>CROSS SECTION</p>	<p>BEAD PLATE TOP</p>	<p>9528/ NBD-14404</p> <p>PISTON BOTTOM</p> <p>ORDER NO. WC1-358-0667</p>
		<p>APPLICATIONS: Holland (Neway) 90557232</p>

BELLOWS 1T15V3	AON W01-358-9582	C01-358-5098 13.03 Composite
<p>CROSS SECTION</p>	<p>BEAD PLATE TOP</p>	<p>9528/ NBD-14404</p> <p>PISTON BOTTOM</p> <p>ORDER NO. WC1-358-0667</p>
		<p>SPACER WC1-358-3701</p> <p>APPLICATIONS: Holland (Neway) 90557240 REPLACEMENT PISTON DOES NOT INCLUDE SPACER</p> <p>OBSOLETE: NO LONGER AVAILABLE</p>

BELLOWS 1T15V8	AON W01-358-9274	C01-358-5105 19.03 Composite
<p>CROSS SECTION</p>	<p>BEAD PLATE TOP</p>	<p>9462/FIP-101776</p> <p>PISTON BOTTOM</p>
		<p>APPLICATIONS: Ridewell 1003589274C</p>

- HARDWARE KEY**
- Bolt or Stud 1/2-13
 - ⊗ Air Inlet 1/4 N.P.T.
 - ⊗ Combination Stud/Air Inlet Stud Outside Thread is 3/4-16 Pistons
 - ⊗ Exception to Standard Stud/Air Inlet Stud Inside Thread of 1/4 N.P.T.

- ▲ No Alignment Specified-Center Stud Mounting is Standard
- ⊗ Threaded Hole 3/8-16 Blind Nut on Bead Plates 1/2-13 Pistons

BELLOWS 1T15V8	AON W01-358-9275	C01-358-5105 19.26 Composite
<p>CROSS SECTION</p>	<p>3235 BEAD PLATE TOP</p> <p>9462/FIP-101776 PISTON BOTTOM</p>	<p>APPLICATIONS: Ridewell 1003589275C</p>
BELLOWS 1T15V8	AON W01-358-9470	C01-358-5105 16.18 Composite
<p>CROSS SECTION</p>	<p>3253 BEAD PLATE TOP</p> <p>9532/ NAD-29827 PISTON BOTTOM</p> <p>ORDER NO. WC1-358-1619</p>	<p>BRACKET WC1-358-3887</p> <p>APPLICATIONS: Holland (Neway) 90557145 (AD-246) Holland (Neway) 90557211 (2 bolt mounting on piston)</p>
BELLOWS 1T15V8	AON W01-358-9471	C01-358-5105 17.77 Composite
<p>CROSS SECTION</p>	<p>3253 BEAD PLATE TOP</p> <p>9540/ NAD-29828 PISTON BOTTOM</p> <p>ORDER NO. WC1-358-0664</p>	<p>BRACKET WC1-358-3887</p> <p>APPLICATIONS: Holland (Neway) (AD-123/246-10) 90557146 90557182 (no bracket) 90557177 (special lower connection) Holland (Neway) 90557212 (146) Holland (Neway) 90557214 (182) (2 bolt mounting on piston)</p>
BELLOWS 1T15V8	AON W01-358-9472	C01-358-5105 16.20 Composite
<p>CROSS SECTION</p>	<p>3253 BEAD PLATE TOP</p> <p>9544/ NAD-29826 PISTON BOTTOM</p> <p>ORDER NO. WC1-358-0666</p>	<p>BRACKET WC1-358-3887</p> <p>APPLICATIONS: Holland (Neway) 90557147 (AD-123/246-6.5 & 8.75) 90557213 (147) (2 bolt mounting on piston) 90557178-Ford (special lower connection)</p>
BELLOWS 1T15V8	AON W01-358-9473	C01-358-5105 18.04 Composite
<p>CROSS SECTION</p>	<p>3253 BEAD PLATE TOP</p> <p>9540/ NAD-29828 PISTON BOTTOM</p> <p>ORDER NO. WC1-358-0664</p>	<p>BRACKET WC1-358-3887</p> <p>APPLICATIONS: Holland (Neway) 90557152 90557179 (no bracket) 90557215 (152) 90557216 (179) (2 bolt mounting on piston)</p>

<p>BELLOWS 1T15V8</p> <p>CROSS SECTION</p>	<p>AON W01-358-9491</p> <p>3253 BEAD PLATE TOP</p> <p>9727/NBD-8725 PISTON BOTTOM</p> <p>Order No. WC1-358-0651</p>	<p>C01-358-5105 18.44 Aluminum</p> <p>BRACKET WC1-358-3887</p> <p>APPLICATIONS: Holland (Neway) 90557206 90557213 REPLACEMENT PISTON COMES WITHOUT STUDS</p>
<p>BELLOWS 1T15V8</p> <p>CROSS SECTION</p>	<p>AON W01-358-9501</p> <p>3253 BEAD PLATE TOP</p> <p>9553/ NAD-29467 PISTON BOTTOM</p> <p>ORDER NO. WC1-358-9453</p>	<p>C01-358-5105 17.58 Composite</p> <p>APPLICATIONS: Holland 90557214 REPLACEMENT PISTON COMES WITHOUT STUDS</p>
<p>BELLOWS 1T15V8</p> <p>CROSS SECTION</p>	<p>AON W01-358-9502</p> <p>3253 BEAD PLATE TOP</p> <p>9530/ NAD-27908 PISTON BOTTOM</p> <p>ORDER NO. WC1-358-9452</p>	<p>C01-358-5105 16.70 Composite</p> <p>APPLICATIONS: Holland 90557211 REPLACEMENT PISTON COMES WITHOUT STUDS</p> <p>OBSELETE: NO LONGER AVAILABLE</p>
<p>BELLOWS 1T15V8</p> <p>CROSS SECTION</p>	<p>AON W01-358-9504</p> <p>3253 BEAD PLATE TOP</p> <p>9530/ NAD-29467 PISTON BOTTOM</p> <p>ORDER NO. WC1-358-9453</p>	<p>C01-358-5105 17.91 Composite</p> <p>APPLICATIONS: Holland 90557216</p>
<p>BELLOWS 1T15V11</p> <p>CROSS SECTION</p>	<p>AON W01-358-9250</p> <p>3235 BEAD PLATE TOP</p> <p>9803 / NAD-15324 PISTON BOTTOM</p> <p>ORDER NO. WC1-358-0680</p>	<p>C01-358-5133 23.57 Aluminum</p> <p>APPLICATIONS: Ridewell 1003589250C Silent Drive</p>

HARDWARE KEY

- Bolt or Stud 1/2-13
- ⊗ Air Inlet 1/4 N.P.T.
- ⊗ Combination Stud/Air Inlet Stud Outside Thread is 3/4-16 Pistons
- ⊗ Exception to Standard Stud/Air Inlet Stud Inside Thread of 1/4 N.P.T.

- ▲ No Alignment Specified-Center Stud Mounting is Standard
- ⊗ Threaded Hole 3/8-16 Blind Nut on Bead Plates 1/2-13 Pistons

<p>BELLOWS 1T15VMR8</p>	<p>AON W01-358-9865</p>	<p>C01-358-5085 14.55 Composite</p>
<p>CROSS SECTION</p>	<p>BEAD PLATE TOP</p>	<p>9485/FIP-101705</p> <p>APPLICATIONS: Hendrickson 67043-2</p>
<p>BELLOWS 1T15VMR8</p>	<p>AON W01-358-9866</p>	<p>C01-358-5085 18.00 Composite</p>
<p>CROSS SECTION</p>	<p>BEAD PLATE TOP</p>	<p>9485/FIP-101705</p> <p>APPLICATIONS: Hendrickson 67391-2</p>
<p>BELLOWS 1T15VMW8</p>	<p>AON W01-358-6258</p>	<p>C01-358-5087 14.54 Composite</p>
<p>CROSS SECTION</p>	<p>BEAD PLATE TOP</p>	<p>9557/ NAD-31181</p> <p>APPLICATIONS: Arvin Meritor 21227892 FS25</p> <p>ORDER NO. WC1-358-1654</p> <p>PISTON BOTTOM</p>
<p>BELLOWS 1T15VP4</p>	<p>AON W01-358-8800</p>	<p>C01-358-5090 21.50 Steel</p>
<p>CROSS SECTION</p>	<p>BEAD PLATE TOP</p>	<p>9648/NAD-31288</p> <p>APPLICATIONS: Hendrickson Trailer S-25559</p> <p>Order No. WC1-358-1649</p> <p>PISTON BOTTOM</p>
<p>BELLOWS 1T15VP4</p>	<p>AON W01-358-9270</p>	<p>C01-358-5090 14.27 Aluminum</p>
<p>CROSS SECTION</p>	<p>BEAD PLATE TOP</p>	<p>9602/ NAD-28351</p> <p>APPLICATIONS: Hendrickson S-20010 (HT230T) ref.S21208 (different bead plate) Also replaces 1T15VM-4.0</p> <p>ORDER NO. WC1-358-1613</p> <p>PISTON BOTTOM</p> <p>REPLACES 1T15VM4</p>

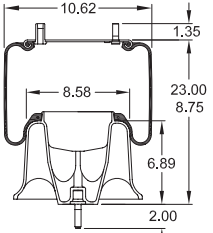
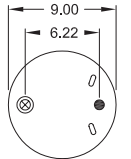
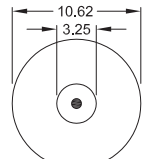
BELLOWS 1T15XBZR7.5	AON W01-358-9780	 <p>CROSS SECTION</p>	<p>3191</p>  <p>BEAD PLATE TOP</p>	<p>9527/NAD-27265 PLASTIC</p>  <p>PISTON BOTTOM</p>	<p>Order No. WC1-358-1627</p>	<p>C01-358-0572 13.24 Composite</p>
<p>APPLICATIONS: Freightliner 16-13810-000 (composite) Freightliner 681-320-0017 (aluminum) - see W01-358-9781 Freightliner Piston 16-1673-000 (steel) - see W01-358-9782 A16-18335-000 A16-18335-001</p>						
REPLACES 1T15ZR6						

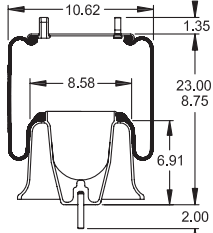
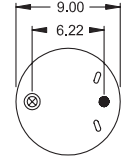
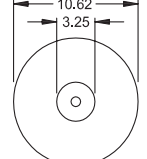
BELLOWS 1T15XBZR7.5	AON W01-358-9781	 <p>CROSS SECTION</p>	<p>3191</p>  <p>BEAD PLATE TOP</p>	<p>9604/NAD-30174</p>  <p>PISTON BOTTOM</p>	<p>Order No. WC1-358-1624</p>	<p>C01-358-0572 17.00 Aluminum</p>
<p>APPLICATIONS: Freightliner 681-320-0017, A16-14004-000 (aluminum) A16-17574-001 (w/o bracket) A16-17574-002 (w/o bracket) Freightliner Piston 16-13840-000 (composite) - see W01-358-9780 Freightliner Piston 16-16773-000 (steel) - see W01-358-9782 A16-17574-001 A16-17574-002</p>						
REPLACES 1T15ZR6						

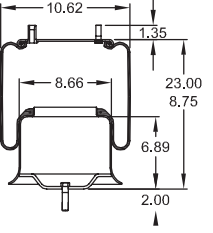
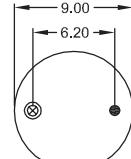
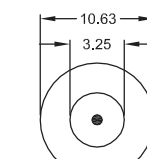
BELLOWS 1T15XBZR7.5	AON W01-358-9782	 <p>CROSS SECTION</p>	<p>3191</p>  <p>BEAD PLATE TOP</p>	<p>9676/ NAD-31612</p>  <p>PISTON BOTTOM</p>	<p>ORDER NO. N/A</p>	<p>C01-358-0572 21.00 Steel</p>
<p>APPLICATIONS: Freightliner Custom Chassis 16-16773-000 (steel) 681-320-0017 (aluminum) - see W01-358-9781 16-13810-000 (composite) -see W01-358-9780</p>						
REPLACES 1T15ZR6						

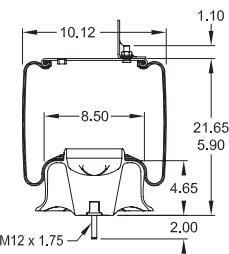
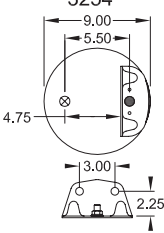
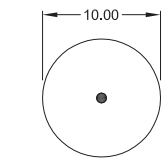
BELLOWS 1T15XMR7	AON W01-358-8829	 <p>CROSS SECTION</p>	<p>3254</p>  <p>BEAD PLATE TOP</p>	<p>4008/FIP-101526</p>  <p>PISTON BOTTOM</p>	<p>BRACKET WC1-358-3873</p>	<p>C01-358-1179 11.90 Composite</p>
<p>APPLICATIONS: Volvo 3934699 Volvo 8079902</p>						
REPLACES 1T15M6						

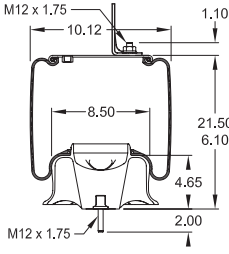
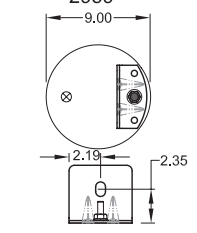
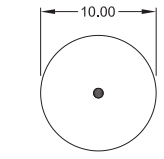
BELLOWS 1T15XMR7	AON W01-M58-8463	 <p>CROSS SECTION</p>	<p>2959</p>  <p>BEAD PLATE TOP</p>	<p>4008/FIP-101526</p>  <p>PISTON BOTTOM</p>	<p>BRACKET 70-3582-6070</p>	<p>C01-358-1179 14.70 Composite</p>
<p>APPLICATIONS: Volvo 20733034 Goodyear 1R12-647</p>						

HARDWARE KEY

- Bolt or Stud 1/2-13
- ⊗ Air Inlet 1/4 N.P.T.
- ⊗ Combination Stud/Air Inlet Stud Outside Thread is 3/4-16 Pistons
- ⊗ Exception to Standard Stud/Air Inlet Stud Inside Thread of 1/4 N.P.T.

- ▲ No Alignment Specified-Center Stud Mounting is Standard
- ⊗ Threaded Hole 3/8-16 Blind Nut on Bead Plates 1/2-13 Pistons

<p>BELLOWS 1T15XMR7</p>	<p>AON W01-M58-8468</p>	<p>C01-358-1179 11.20 Composite</p>
<p>CROSS SECTION</p>	<p>BEAD PLATE TOP</p>	<p>4008/FIP-101526</p> <p>PISTON BOTTOM</p> <p>APPLICATIONS: Volvo 21132005 Goodyear 1R12-654</p>
<p>BELLOWS 1T15XNR5</p>	<p>AON W01-358-9648</p>	<p>C01-358-1178 12.37 Composite</p>
<p>CROSS SECTION</p>	<p>BEAD PLATE TOP</p>	<p>4008/FIP-101526</p> <p>PISTON BOTTOM</p> <p>BRACKET 70-3582-6047</p> <p>APPLICATIONS: Navistar 2027911C1 & C2</p> <p>REPLACES 1T15M8</p>
<p>BELLOWS 1T15XR9</p>	<p>AON W01-358-1190</p>	<p>C01-358-1180 12.75 Composite</p>
<p>CROSS SECTION</p>	<p>BEAD PLATE TOP</p>	<p>4008/FIP-101526</p> <p>PISTON BOTTOM</p> <p>APPLICATIONS: Bead plate Bracket (Double Hole) 70-358-6064 Navistar 3541732C1 Goodyear 1R12-523</p> <p>REPLACES W01-358-9876</p>
<p>BELLOWS 1T15XR9</p>	<p>AON W01-358-1191</p>	<p>C01-358-1180 12.20 Composite</p>
<p>CROSS SECTION</p>	<p>BEAD PLATE TOP</p>	<p>4008/FIP-101526</p> <p>PISTON BOTTOM</p> <p>APPLICATIONS: Bead plate Bracket (Single Hole) 70-358-6063 Navistar 3541731C1 Goodyear 1R12-432</p> <p>REPLACES W01-358-9875</p>
<p>BELLOWS 1T15XR9</p>	<p>AON W01-358-1192</p>	<p>C01-358-1180 12.20 Composite</p>
<p>CROSS SECTION</p>	<p>BEAD PLATE TOP</p>	<p>4008/FIP-101526</p> <p>PISTON BOTTOM</p> <p>APPLICATIONS: Navistar 3691773C1</p>

BELLOWS 1T17B5	AON W01-358-8631	<p>C01-358-0458 25.45 </p>
<p>CROSS SECTION</p>	<p>3305 </p> <p>BEAD PLATE TOP</p>	<p>9648/NAD-31288 </p> <p>PISTON BOTTOM</p> <p>Order No. WC1-358-1649</p>
<p>APPLICATIONS: Watson & Chalin AS-0098-01F</p>		

BELLOWS 1T17B5	AON W01-358-8723	<p>C01-358-0458 15.24 </p>
<p>CROSS SECTION</p>	<p>3301 </p> <p>BEAD PLATE TOP</p>	<p>9603/ NAD-29630 </p> <p>PISTON BOTTOM</p> <p>ORDER NO. WC1-358-1635</p>
<p>APPLICATIONS: Ridewell 1001R13087 Ridewell 1001R13097</p>		

BELLOWS 1T17B5	AON W01-358-8740	<p>C01-358-0458 15.22 </p>
<p>CROSS SECTION</p>	<p>3244 </p> <p>BEAD PLATE TOP</p>	<p>9602/ NAD-28351 </p> <p>PISTON BOTTOM</p> <p>ORDER NO. WC1-358-1613</p>
<p>APPLICATIONS: Reyco 23433-01</p>		

BELLOWS 1T17B5	AON W01-358-8752	<p>C01-358-0458 15.29 </p>
<p>CROSS SECTION</p>	<p>3301 </p> <p>BEAD PLATE TOP</p>	<p>9602/NAD-28351 </p> <p>PISTON BOTTOM</p> <p>Order No. WC1-358-1613</p>
<p>APPLICATIONS: Watson & Chalin AS-0084 Ridewell 1003588752C Suspensions Inc. 201642 [piston mounting may vary with GY bag-7.87 BC]</p>		

BELLOWS 1T17B5	AON W01-358-8753	<p>C01-358-0458 15.35 </p>
<p>CROSS SECTION</p>	<p>3305 </p> <p>BEAD PLATE TOP</p>	<p>9602/NAD-28351 </p> <p>PISTON BOTTOM</p> <p>Order No. WC1-358-1613</p>
<p>APPLICATIONS: Ridewell 1003588753C Watson & Chalin AS-0098</p>		

- HARDWARE KEY**
- Bolt or Stud 1/2-13
 - ⊗ Air Inlet 1/4 N.P.T.
 - ⊙ Combination Stud/Air Inlet Stud Outside Thread is 3/4-16 Pistons
 - ⊕ Exception to Standard Stud/Air Inlet Stud Inside Thread of 1/4 N.P.T.

- ▲ No Alignment Specified-Center Stud Mounting is Standard
- ⊕ Threaded Hole 3/8-16 Blind Nut on Bead Plates 1/2-13 Pistons

BELLOWS 1T17B5	AON W01-358-8755	C01-358-0458 17.00 Aluminum
<p>CROSS SECTION</p>	<p>BEAD PLATE TOP</p>	<p>9734/ NAD-28002</p> <p>PISTON BOTTOM</p> <p>ORDER NO. WC1-358-1610</p> <p>APPLICATIONS: Hendrickson Trailer S22045 (HK190T) Hendrickson Trailer Prototype C21623</p>
BELLOWS 1T17B5	AON W01-358-8782	C01-358-0458 15.56 Aluminum
<p>CROSS SECTION</p>	<p>BEAD PLATE TOP</p>	<p>9603/ NAD-29630</p> <p>PISTON BOTTOM</p> <p>ORDER NO. WC1-358-1635</p> <p>APPLICATIONS: Ridewell 1001R13109G</p>
BELLOWS 1T17B7	AON W01-358-8720	C01-358-0463 22.27 Composite
<p>CROSS SECTION</p>	<p>BEAD PLATE TOP</p>	<p>9583/FIP-101543</p> <p>PISTON BOTTOM</p> <p>APPLICATIONS: Reyco 22747-01</p>
BELLOWS 1T17B11	AON W01-358-8744	C01-358-0459 16.47 Composite
<p>CROSS SECTION</p>	<p>BEAD PLATE TOP</p>	<p>9540/ NAD-29828</p> <p>PISTON BOTTOM</p> <p>ORDER NO. WC1-358-0664</p> <p>APPLICATIONS: Holland (Neway) 90557243</p>
BELLOWS 1T17B11	AON W01-358-8746	C01-358-0459 15.97 Composite
<p>CROSS SECTION</p>	<p>BEAD PLATE TOP</p>	<p>9532/ NAD-29827</p> <p>PISTON BOTTOM</p> <p>ORDER NO. WC1-358-1619</p> <p>APPLICATIONS: Holland (Neway) 90557235</p>

<p>BELLOWS 1T17B11</p>	<p>AON W01-358-8748</p>	<p>C01-358-0459 16.01 Composite</p>
<p>CROSS SECTION</p>	<p>3301 9532/ NAD-29827</p> <p>BEAD PLATE TOP</p> <p>PISTON BOTTOM</p> <p>ORDER NO. WC1-358-1619</p>	<p>APPLICATIONS: Holland (Neway) 90557167 (AR250-14 & 15)</p>
<p>BELLOWS 1T17B11</p>	<p>AON W01-358-8749</p>	<p>C01-358-0459 17.95 Composite</p>
<p>CROSS SECTION</p>	<p>3301 9540/ NAD-29828</p> <p>BEAD PLATE TOP</p> <p>PISTON BOTTOM</p> <p>ORDER NO. WC1-358-0664</p>	<p>APPLICATIONS: Holland (Neway) 90557168 (AR250-12,16,17)</p>
<p>BELLOWS 1T17BB2</p>	<p>AON W01-358-8729</p>	<p>C01-358-0454 13.15 Composite</p>
<p>CROSS SECTION</p>	<p>3301 9533/ NAD-30515</p> <p>BEAD PLATE TOP</p> <p>PISTON BOTTOM</p> <p>Order No. WC1-358-1644</p>	<p>APPLICATIONS: Meritor 202796 (GY 1R13-130)</p>
<p>BELLOWS 1T17BM6</p>	<p>AON W01-358-8673</p>	<p>C01-358-0420 20.50 Aluminum</p>
<p>CROSS SECTION</p>	<p>3302 9699/NAD-33165</p> <p>BEAD PLATE TOP</p> <p>PISTON BOTTOM</p>	<p>APPLICATIONS: Hendrickson 66643-002</p>
<p>BELLOWS 1T17BP17</p>	<p>AON W01-358-8724</p>	<p>C01-358-0467 38.94 Steel</p>
<p>CROSS SECTION</p>	<p>3301 9646/ NAD-31215</p> <p>BEAD PLATE TOP</p> <p>PISTON BOTTOM</p>	<p>APPLICATIONS: Hendrickson Trailer S22697</p>

HARDWARE KEY

- Bolt or Stud 1/2-13
- ⊗ Air Inlet 1/4 N.P.T.
- ⊗ Combination Stud/Air Inlet Stud Outside Thread is 3/4-16 Pistons
- ⊗ Exception to Standard Stud/Air Inlet Stud Inside Thread of 1/4 N.P.T.

- ▲ No Alignment Specified-Center Stud Mounting is Standard
- ⊗ Threaded Hole 3/8-16 Blind Nut on Bead Plates 1/2-13 Pistons

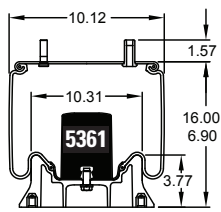
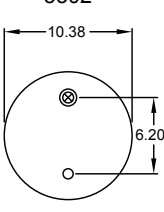
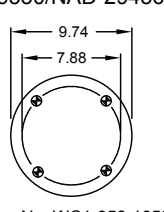
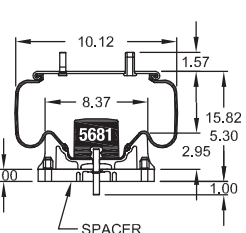
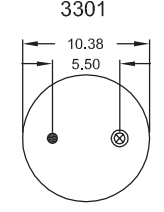
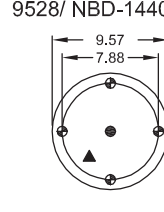
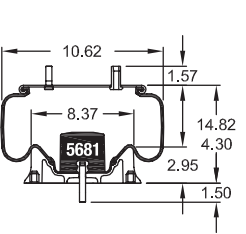
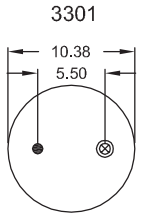
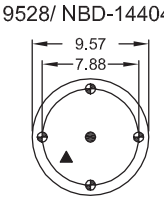
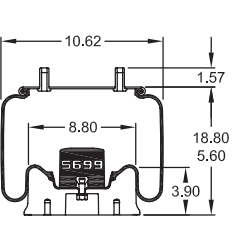
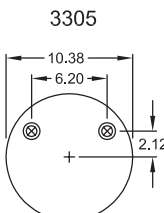
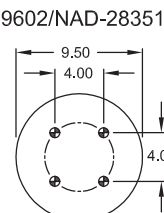
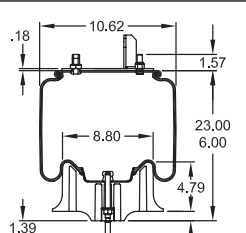
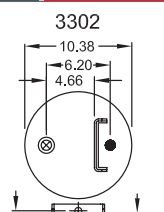
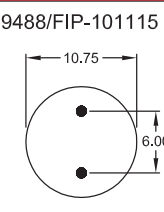
BELLOWS 1T17BV3	AON W01-358-8616	C01-358-0455 13.83 Composite
 <p>CROSS SECTION</p>	 <p>BEAD PLATE TOP</p>	 <p>PISTON BOTTOM</p> <p>Order No. WC1-358-1652</p> <p>APPLICATIONS:</p>
BELLOWS 1T17C3	AON W01-358-8737	C01-358-0469 17.00 Composite
 <p>CROSS SECTION</p>	 <p>BEAD PLATE TOP</p>	 <p>PISTON BOTTOM</p> <p>ORDER NO. WC1-358-0667</p> <p>APPLICATIONS: Holland (Neway) 90557272 (NS225, NS450, WN225, NSH450)</p>
BELLOWS 1T17C3	AON W01-358-8738	C01-358-0469 12.82 Composite
 <p>CROSS SECTION</p>	 <p>BEAD PLATE TOP</p>	 <p>PISTON BOTTOM</p> <p>ORDER NO. WC1-358-0667</p> <p>APPLICATIONS: Holland (Neway) 90557271 (NSH225, NSB225, RLU250)</p>
BELLOWS 1T17C6	AON W01-358-8637	C01-358-0466 17.50 Aluminum
 <p>CROSS SECTION</p>	 <p>BEAD PLATE TOP</p>	 <p>PISTON BOTTOM</p> <p>Order No. WC1-358-1613</p> <p>APPLICATIONS: Watson & Chalin AS-0107</p>
BELLOWS 1T17C8	AON W01-358-8109	C01-358-0416 20.90 Composite
 <p>CROSS SECTION</p>	 <p>BEAD PLATE TOP</p>	 <p>PISTON BOTTOM</p> <p>APPLICATIONS: Hendrickson 67234-002</p>

BELLOWS 1T17C8	AON W01-M58-8712	C01-M58-0475	19.68	Aluminum	
<p>CROSS SECTION</p>	<p>BEAD PLATE TOP</p>	<p>PISTON BOTTOM</p>	APPLICATIONS: Hendrickson 59319-2		

BELLOWS 1T17CA3	AON W01-358-8614	C01-358-0417	24.00	Steel	
<p>CROSS SECTION</p>	<p>BEAD PLATE TOP</p>	<p>PISTON BOTTOM</p>	APPLICATIONS: Hendrickson Trailer S26773 Wilson Trailer		

BELLOWS 1T17CA5	AON W01-358-8709	C01-358-0471	14.15	Composite	
<p>CROSS SECTION</p>	<p>BEAD PLATE TOP</p>	<p>PISTON BOTTOM</p>	APPLICATIONS: Hendrickson Trailer S21800 (Intraax AA230) [8/97-up] Replaces W01-358-8751 (approx. 6/98)		

BELLOWS 1T17CA6.5	AON W01-358-8708	C01-358-0473	15.20	Composite	
<p>CROSS SECTION</p>	<p>BEAD PLATE TOP</p>	<p>PISTON BOTTOM</p>	APPLICATIONS: Hendrickson Trailer S21966 (HKA200 Special)		

BELLOWS 1T17CA6.5	AON W01-358-8713	C01-358-0473	17.96	Composite	
<p>CROSS SECTION</p>	<p>BEAD PLATE TOP</p>	<p>PISTON BOTTOM</p>	APPLICATIONS: Hendrickson Trailer S22948 (Van Traax) Prior to 9/99 - use 9525 piston with bumper spacer		

HARDWARE KEY

- Bolt or Stud 1/2-13
- ⊗ Air Inlet 1/4 N.P.T.
- ⊗ Combination Stud/Air Inlet Stud Outside Thread is 3/4-16 Pistons
- ⊗ Exception to Standard Stud/Air Inlet Stud Inside Thread of 1/4 N.P.T.

▲ No Alignment Specified-Center Stud Mounting is Standard
 ⊗ Threaded Hole 3/8-16 Blind Nut on Bead Plates 1/2-13 Pistons



BELLOWS 1T17CA6.5	AON W01-358-8735	C01-358-0473 17.00 Aluminum
<p>CROSS SECTION</p>	<p>3302</p> <p>BEAD PLATE TOP</p> <p>9603/ NAD-29630</p> <p>PISTON BOTTOM</p> <p>ORDER NO. WC1-358-1635</p>	<p>APPLICATIONS: Granning 7901 [1T19F-7]</p> <p>REPLACES W01-681-8770</p>
BELLOWS 1T17CD3	AON W01-358-8617	C01-358-0453 13.52 Composite
<p>CROSS SECTION</p>	<p>3301</p> <p>BEAD PLATE TOP</p> <p>9533/ NAD-30515</p> <p>PISTON BOTTOM</p> <p>ORDER NO. WC1-358-1635</p>	<p>APPLICATIONS: Arvin Meritor A2258-E-1461 RHP-55 Arvin Meritor 202796 Ride Sentry</p>
BELLOWS 1T17CL5	AON W01-358-8710	C01-358-0470 17.52 Aluminum
<p>CROSS SECTION</p>	<p>3300</p> <p>BEAD PLATE TOP</p> <p>9802/ NAD-27999</p> <p>PISTON BOTTOM</p> <p>ORDER NO. WC1-358-1611</p>	<p>APPLICATIONS: Hendrickson Trailer S22046 (HK230) Approximate availability 1-98</p> <p>REPLACES W01-358-8756</p>
BELLOWS 1T17CL9.5	AON W01-358-9580	C01-358-0452 18.87 Aluminum
<p>CROSS SECTION</p>	<p>3244</p> <p>BEAD PLATE TOP</p> <p>9689/NAD-28838</p> <p>PISTON BOTTOM</p> <p>Order No. WC1-358-1607</p>	<p>APPLICATIONS: Hendrickson Trailer S20127 [HT-250U 9-006] [HT-250UY 9Y-006]</p> <p>REPLACES 1T15VLT10.5, 1T15V11 AND W01-358-9262</p>
BELLOWS 1T17CL9.5	AON W01-358-9581	C01-358-0452 18.96 Aluminum
<p>CROSS SECTION</p>	<p>3244</p> <p>BEAD PLATE TOP</p> <p>9689/ NAD-28838</p> <p>PISTON BOTTOM</p> <p>ORDER NO. WC1-358-1607</p>	<p>APPLICATIONS: Hendrickson Trailer S20414 [HT-250U (9-006)] [HT-250U-Y (9Y-006)]</p> <p>REPLACES 1T15VLT10.5 AND 1T15V11</p>

<p>BELLOWS 1T17DCJ8.5</p> <p>CROSS SECTION</p>	<p>AON W01-M58-8608</p> <p>3405 BEAD PLATE TOP</p> <p>3850/NAD-28198 PISTON BOTTOM</p>	<p>C01-M58-2217 13.89 Composite</p> <p>APPLICATIONS:</p>
<p>BELLOWS 1T17GJ6</p> <p>CROSS SECTION</p>	<p>AON W01-358-8539</p> <p>3301 BEAD PLATE TOP</p> <p>9594 / NAD-28384 PISTON BOTTOM</p>	<p>C01-358-0394 30.60 Composite</p> <p>APPLICATIONS: Dana/Spicer SR1VA101-1 SR1VA105</p>
<p>BELLOWS 1T19L3</p> <p>CROSS SECTION</p>	<p>AON W01-358-8760</p> <p>3388 BEAD PLATE TOP</p> <p>9766/NAD-28978 PISTON BOTTOM</p> <p>ORDER NO. WC1-358-0631</p>	<p>C01-358-0526 19.03 Aluminum</p> <p>APPLICATIONS: Granning 7593</p>
<p>BELLOWS 1T19L5</p> <p>CROSS SECTION</p>	<p>AON W01-358-8500</p> <p>3388 BEAD PLATE TOP</p> <p>9766/NAD-28978 PISTON BOTTOM</p> <p>Order No. WC1-358-0631</p>	<p>C01-358-5356 20.96 Aluminum</p> <p>APPLICATIONS: Rowe RV ASC1000/ ASC1001ASC1002/ ASC1003 Spartan</p>
<p>BELLOWS 1T19L5</p> <p>CROSS SECTION</p>	<p>AON W01-358-9200</p> <p>3506 BEAD PLATE TOP</p> <p>9766/NAD-28978 PISTON BOTTOM</p> <p>Order No. WC1-358-0631</p>	<p>C01-358-5356 21.74 Aluminum</p> <p>APPLICATIONS: Hendrickson Trailer S3839 Ridewell 1003589200C Mexican De Autobus Front-Rear Tag</p>

HARDWARE KEY

- Bolt or Stud 1/2-13
- ⊗ Air Inlet 1/4 N.P.T.
- ⊙ Combination Stud/Air Inlet Stud Outside Thread is 3/4-16 Pistons
- ⊕ Exception to Standard Stud/Air Inlet Stud Inside Thread of 1/4 N.P.T.

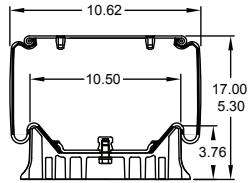
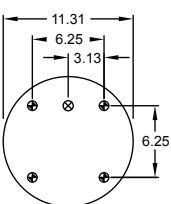
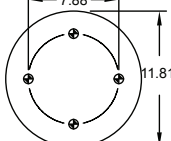
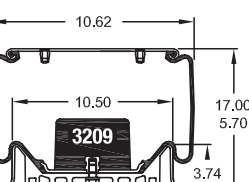
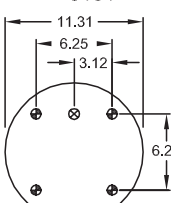
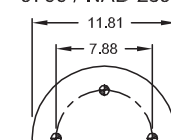
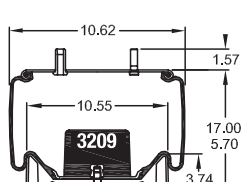
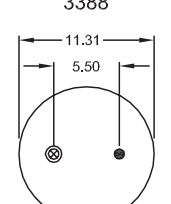
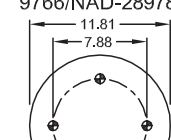
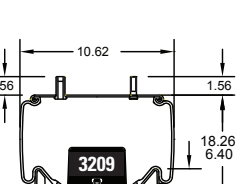
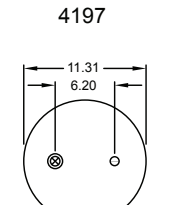
- ▲ No Alignment Specified-Center Stud Mounting is Standard
- ⊕ Threaded Hole 3/8-16 Blind Nut on Bead Plates 1/2-13 Pistons

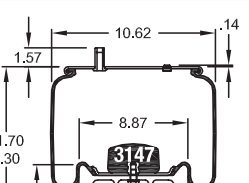
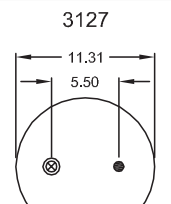
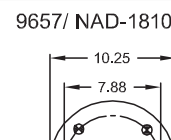
<p>BELLOWS 1T19L5</p>	<p>AON W01-358-9206</p>	<p>C01-358-5356 18.46 Aluminum</p>
 <p>CROSS SECTION</p>	<p>4192</p>  <p>BEAD PLATE TOP</p> <p>6848/FIP-103899 OR 9766/NAD-28978</p>  <p>PISTON BOTTOM</p> <p>Order No. WC1-358-0631</p>	<p>APPLICATIONS:</p>
<p>BELLOWS 1T19L5</p>	<p>AON W01-358-9215</p>	<p>C01-358-5356 21.31 Aluminum</p>
 <p>CROSS SECTION</p>	<p>3131</p>  <p>BEAD PLATE TOP</p> <p>9766 / NAD-28978</p>  <p>PISTON BOTTOM</p> <p>Order No. WC1-358-0631</p>	<p>APPLICATIONS: Hendrickson Trailer S3648</p>
<p>BELLOWS 1T19L5</p>	<p>AON W01-358-9218</p>	<p>C01-358-5356 21.42 Aluminum</p>
 <p>CROSS SECTION</p>	<p>3388</p>  <p>BEAD PLATE TOP</p> <p>9766/NAD-28978</p>  <p>PISTON BOTTOM</p> <p>Order No. WC1-358-0631</p>	<p>APPLICATIONS: Ridewell 1003589218C Holland (Neway) 90557209 Suspensions Inc. Watson & Chalin AS-0073 Rowe RV ASC1000 / ASC1001 / ASC1002 / ASC1003 Spartan</p>
<p>BELLOWS 1T19L5</p>	<p>AON W01-358-9801</p>	<p>C01-358-5356 21.47 Aluminum</p>
 <p>CROSS SECTION</p>	<p>4197</p>  <p>BEAD PLATE TOP</p> <p>6848/FIP-103899 OR 9766/NAD-28978</p>  <p>PISTON BOTTOM</p> <p>Order No. WC1-358-0631</p>	<p>APPLICATIONS:</p>
<p>BELLOWS 1T19L7</p>	<p>AON W01-358-8778</p>	<p>C01-358-0501 22.66 Aluminum</p>
 <p>CROSS SECTION</p>	<p>3127</p>  <p>BEAD PLATE TOP</p> <p>9657/ NAD-18101</p>  <p>PISTON BOTTOM</p> <p>ORDER NO. WC1-358-9450</p>	<p>APPLICATIONS: Holland (Neway) 90557164</p>

<p>BELLOWS 1T19L7</p> <p>CROSS SECTION</p>	<p>AON W01-358-8980</p> <p>BEAD PLATE TOP</p> <p>PISTON BOTTOM</p>	<p>C01-358-0501 21.20 Composite</p> <p>APPLICATIONS:</p>
<p>BELLOWS 1T19L7</p> <p>CROSS SECTION</p>	<p>AON W01-358-9121</p> <p>BEAD PLATE TOP</p> <p>PISTON BOTTOM</p> <p>Order No. WC1-358-9450</p>	<p>C01-358-0501 21.73 Aluminum</p> <p>APPLICATIONS: Holland (Neway) 90557019, 90557052, 90557078, 90557083 90557110 (parallel alignment) R & S Truck & Body 1090023 Ridewell 1003589121C Sauer P50-733 Reyco 12882-02 Watson & Chalin AS-0013</p>
<p>BELLOWS 1T19L7</p> <p>CROSS SECTION</p>	<p>AON W01-358-9135</p> <p>BEAD PLATE TOP</p> <p>PISTON BOTTOM</p>	<p>C01-358-0501 30.59 Aluminum</p> <p>APPLICATIONS: Dart 21-4048 Unit Rig 1016034</p>
<p>BELLOWS 1T19L7</p> <p>CROSS SECTION</p>	<p>AON W01-358-9141</p> <p>BEAD PLATE TOP</p> <p>PISTON BOTTOM</p>	<p>C01-358-0501 22.50 Aluminum</p> <p>APPLICATIONS: Neway 90557110</p>
<p>BELLOWS 1T19L7</p> <p>CROSS SECTION</p>	<p>AON W01-358-9144</p> <p>BEAD PLATE TOP</p> <p>PISTON BOTTOM</p> <p>Order No. WC1-358-9450</p>	<p>C01-358-0501 24.20 Aluminum</p> <p>APPLICATIONS: Holland (Neway) 90557155</p>

HARDWARE KEY

- Bolt or Stud 1/2-13
- ⊗ Air Inlet 1/4 N.P.T.
- ⊗ Combination Stud/Air Inlet Stud Outside Thread is 3/4-16 Pistons
- ⊗ Exception to Standard Stud/Air Inlet Stud Inside Thread of 1/4 N.P.T.

- ▲ No Alignment Specified-Center Stud Mounting is Standard
- ⊗ Threaded Hole 3/8-16 Blind Nut on Bead Plates 1/2-13 Pistons

BELLOWS 1T19L7	AON W01-358-9148	C01-358-0501 20.89 Aluminum
<p>CROSS SECTION</p>	<p>BEAD PLATE TOP</p>	<p>PISTON BOTTOM</p> <p>Order No. WC1-358-9450</p> <p>APPLICATIONS: Peerless 0550-00070</p>
BELLOWS 1T19L7	AON W01-358-9149	C01-358-0501 21.80 Aluminum
<p>CROSS SECTION</p>	<p>BEAD PLATE TOP</p>	<p>PISTON BOTTOM</p> <p>Order No. WC1-358-9450</p> <p>APPLICATIONS: City Welding Peerless 0550-00010</p>
BELLOWS 1T19L7	AON W01-358-9177	C01-358-0501 21.76 Aluminum
<p>CROSS SECTION</p>	<p>BEAD PLATE TOP</p>	<p>PISTON BOTTOM</p> <p>Order No. WC1-358-9450</p> <p>APPLICATIONS: Hendrickson Trailer S2065 R & S Truck & Body 1090216 Holland (Neway) 90557003 Ridewell 1003589177C Columbia Trailer</p>
BELLOWS 1T19L7	AON W01-358-9221	C01-358-0497 21.36 Aluminum
<p>CROSS SECTION</p>	<p>BEAD PLATE TOP</p>	<p>PISTON BOTTOM</p> <p>Order No. WC1-358-9450</p> <p>APPLICATIONS: Load Air P60733</p>
BELLOWS 1T19L7	AON W01-358-9280	C01-358-0501 20.13 Composite
<p>CROSS SECTION</p>	<p>BEAD PLATE TOP</p>	<p>PISTON BOTTOM</p> <p>APPLICATIONS:</p>

<p>BELLOWS 1T19L7</p>	<p>AON W01-358-9811</p>	<p>C01-358-0501 19.56 Aluminum</p>
<p>CROSS SECTION</p>	<p>BEAD PLATE TOP</p>	<p>PISTON BOTTOM</p> <p>Order No. WC1-358-0631</p> <p>APPLICATIONS: Rowe Truck ASCC2000 Ride</p>
<p>BELLOWS 1T19L9</p>	<p>AON W01-358-8779</p>	<p>C01-358-1169 20.20 Aluminum</p>
<p>CROSS SECTION</p>	<p>BEAD PLATE TOP</p>	<p>PISTON BOTTOM</p> <p>ORDER NO. WC1-358-9450</p> <p>OBSOLETE: NO LONGER AVAILABLE</p>
<p>BELLOWS 1T19L9</p>	<p>AON W01-358-8780</p>	<p>C01-358-1169 19.90 Aluminum</p>
<p>CROSS SECTION</p>	<p>BEAD PLATE TOP</p>	<p>PISTON BOTTOM</p> <p>ORDER NO. WC1-358-9450</p> <p>APPLICATIONS: Holland (Neway) 90557162</p>
<p>BELLOWS 1T19L9</p>	<p>AON W01-358-8781</p>	<p>C01-358-1169 19.89 Composite</p>
<p>CROSS SECTION</p>	<p>BEAD PLATE TOP</p>	<p>PISTON BOTTOM</p> <p>ORDER NO. WC1-358-0528</p> <p>APPLICATIONS: Holland (Neway) 90557205</p>
<p>BELLOWS 1T19L9</p>	<p>AON W01-358-9134</p>	<p>C01-358-1169 19.88 Aluminum</p>
<p>CROSS SECTION</p>	<p>BEAD PLATE TOP</p>	<p>PISTON BOTTOM</p> <p>Order No. WC1-358-9450</p> <p>APPLICATIONS: Holland (Neway) 90557125 (AR-80-9) (AR-80-9WST)</p>

HARDWARE KEY

- Bolt or Stud 1/2-13
- ⊗ Air Inlet 1/4 N.P.T.
- ⊗ Combination Stud/Air Inlet Stud Outside Thread is 3/4-16 Pistons
- ⊗ Exception to Standard Stud/Air Inlet Stud Inside Thread of 1/4 N.P.T.

- ▲ No Alignment Specified-Center Stud Mounting is Standard
- ⊗ Threaded Hole 3/8-16 Blind Nut on Bead Plates 1/2-13 Pistons

BELLOWS 1T19L9	AON W01-358-9138	C01-358-1169 20.03 Aluminum
<p>CROSS SECTION</p>	<p>BEAD PLATE TOP</p>	<p>PISTON BOTTOM</p> <p>Order No. WC1-358-9450</p>
BELLOWS 1T19L11	AON W01-358-8792	C01-358-0525 23.91 Aluminum
<p>CROSS SECTION</p>	<p>BEAD PLATE TOP</p>	<p>PISTON BOTTOM</p> <p>Order No. WC1-358-1640</p>
BELLOWS 1T19L11	AON W01-358-8796	C01-358-0525 19.92 Composite
<p>CROSS SECTION</p>	<p>BEAD PLATE TOP</p>	<p>PISTON BOTTOM</p> <p>ORDER NO. WC1-358-0528</p>
BELLOWS 1T19L11	AON W01-358-9122	C01-358-0525 23.11 Composite
<p>CROSS SECTION</p>	<p>BEAD PLATE TOP</p>	<p>PISTON BOTTOM</p> <p>Order No. WC1-358-0528</p>
BELLOWS 1T19L11	AON W01-358-9156	C01-358-0525 21.32 Composite
<p>CROSS SECTION</p>	<p>BEAD PLATE TOP</p>	<p>PISTON BOTTOM</p> <p>Order No. WC1-358-0528</p>
BELLOWS 1T19L11	AON W01-358-9156	C01-358-0525 21.32 Composite
<p>CROSS SECTION</p>	<p>BEAD PLATE TOP</p>	<p>PISTON BOTTOM</p> <p>Order No. WC1-358-0528</p>

BELLOWS 1T19L11	AON W01-358-9158	C01-358-0525	21.81	Composite
<p>CROSS SECTION</p>	<p>3506 BEAD PLATE TOP</p>	<p>9580 / NAD-27909 PISTON BOTTOM</p>	<p>APPLICATIONS: Hendrickson Can. B-12514-004, B-12514-011 Holland (Neway) 90557005 Hendrickson Trailer S2063 Holland (Neway) 90557069 Peerless Ridewell 1003589158C Porcupine MFG.SV.# Neway 90044197</p>	

BELLOWS 1T19L11	AON W01-358-9804	C01-358-0525	23.33	Aluminum
<p>CROSS SECTION</p>	<p>3196 BEAD PLATE TOP</p>	<p>9657/NAD-18101 PISTON BOTTOM</p>	<p>APPLICATIONS: Watson & Chalin AS-0162-1G Ridewell 1000006 Goodyear 1R14-151</p>	

BELLOWS 1T19L11	AON W01-358-9985	C01-358-0525	22.30	Composite
<p>CROSS SECTION</p>	<p>3388 BEAD PLATE TOP</p>	<p>9562/NAD-33610 PISTON BOTTOM</p>	<p>APPLICATIONS: Watson & Chalin AS-0081</p>	

BELLOWS 1T19L11	AON W01-M58-6339	C01-M58-0499	23.62	Aluminum
<p>CROSS SECTION</p>	<p>3196 BEAD PLATE TOP</p>	<p>9562/NAD-33610 PISTON BOTTOM</p>	<p>APPLICATIONS: R.O.R./Meritor 21215633, SAF 2 229 0003 00, Wewerler US 07345F Trailer 0036/58 E Viberti 128147122, SAE 8403/102, TEC 505859/01 Terberg 21071483, York 785170, CF Gomma 1T19E-2, 87408</p> <p>OBSELETE: NO LONGER AVAILABLE</p>	

BELLOWS 1T19L12	AON W01-358-5503	C01-358-0522	21.77	Composite
<p>CROSS SECTION</p>	<p>3388 BEAD PLATE TOP</p>	<p>9580/NAD-27909 PISTON BOTTOM</p>	<p>SERVICE ASSEMBLY W01 M58 7238</p> <p>APPLICATIONS: Holland (Neway) 90557200 Watson & Chalin AS-0047</p>	

HARDWARE KEY

- Bolt or Stud 1/2-13
- ⊗ Air Inlet 1/4 N.P.T.
- ⊕ Combination Stud/Air Inlet Stud Outside Thread is 3/4-16 Pistons
- ⊖ Exception to Standard Stud/Air Inlet Stud Inside Thread of 1/4 N.P.T.

- ▲ No Alignment Specified-Center Stud Mounting is Standard
- ⊕ Threaded Hole 3/8-16 Blind Nut on Bead Plates 1/2-13 Pistons

<p>BELLOWS 1T19L12</p>	<p>AON W01-358-5505</p>	<p>C01-358-0496 24.00 Aluminum</p>	
<p>CROSS SECTION</p>	<p>3388</p> <p>BEAD PLATE TOP</p>	<p>9669/NAD-26291</p> <p>Order No. WC1-358-1602</p> <p>PISTON BOTTOM</p>	<p>APPLICATIONS: Holland (Neway) 90557103</p>
<p>BELLOWS 1T19L12</p>	<p>AON W01-358-5508</p>	<p>C01-358-0522 25.16 Aluminum</p>	
<p>CROSS SECTION</p>	<p>3388</p> <p>BEAD PLATE TOP</p>	<p>9669 / NAD-26291</p> <p>Order No. WC1-358-1602</p> <p>PISTON BOTTOM</p>	<p>APPLICATIONS:</p>
<p>BELLOWS 1T19L12</p>	<p>AON W01-358-5511</p>	<p>C01-358-0522 21.96 Composite</p>	
<p>CROSS SECTION</p>	<p>3388</p> <p>BEAD PLATE TOP</p>	<p>9580/NAD-27909</p> <p>Order No. WC1-358-0528</p> <p>PISTON BOTTOM</p>	<p>APPLICATIONS: Holland (Neway) 90557102 Hendrickson Trailer S22173</p>
<p>BELLOWS 1T19L12</p>	<p>AON W01-358-5514</p>	<p>C01-358-0496 21.87 Composite</p>	
<p>CROSS SECTION</p>	<p>3185</p> <p>BEAD PLATE TOP</p>	<p>9580/NAD-27909</p> <p>Order No. WC1-358-0528</p> <p>PISTON BOTTOM</p>	<p>APPLICATIONS: Watson & Chalin AS-0047G Goodyear 1R14-170</p>
<p>BELLOWS 1T19L12</p>	<p>AON W01-358-9891</p>	<p>C01-358-0522 24.50 Aluminum</p>	
<p>CROSS SECTION</p>	<p>3388</p> <p>BEAD PLATE TOP</p>	<p>9669/NAD-26291</p> <p>Order No. WC1-358-1602</p> <p>PISTON BOTTOM</p>	<p>APPLICATIONS: Holland (Neway) 90557218</p>

BELLOWS 1T19L14	AON W01-358-9264	C01-358-0504	24.87	Aluminum	
<p>CROSS SECTION</p>	<p>3196</p> <p>BEAD PLATE TOP</p>	<p>9669/NAD-26291</p> <p>PISTON BOTTOM</p> <p>Order No. WC1-358-1602</p>	<p>APPLICATIONS: Hendrickson Trailer S13122 [HT250U(9-020)] Holland (Neway) 90557104 Watson Chalin AS-0063</p>		

BELLOWS 1T19L14	AON W01-358-9915	C01-358-0495	24.26	Aluminum	
<p>CROSS SECTION</p>	<p>3388</p> <p>BEAD PLATE TOP</p>	<p>9669/NAD-26291</p> <p>PISTON BOTTOM</p> <p>Order No. WC1-358-1602</p>	<p>APPLICATIONS: Holland (Neway) 90557104 Watson & Chalin AS-0063</p>		

BELLOWS 1T19L16	AON W01-358-9896	C01-358-0527	25.46	Aluminum	
<p>CROSS SECTION</p>	<p>3388</p> <p>BEAD PLATE TOP</p>	<p>9669/NAD-26291</p> <p>PISTON BOTTOM</p> <p>Order No. WC1-358-1602</p>	<p>APPLICATIONS: Neway 90557144 Rotate Piston: 90557133-28 Degrees RH 90557134-28 Degrees LH 90557148 Parallel</p>		

BELLOWS 1T19L16	AON W01-358-9928	C01-358-0527	25.40	Aluminum	
<p>CROSS SECTION</p>	<p>3196</p> <p>BEAD PLATE TOP</p>	<p>9669/NAD-26291</p> <p>PISTON BOTTOM</p> <p>Order No. WC1-358-1602</p>	<p>APPLICATIONS: Suspensions Inc. (Wabash) Hendrickson Trailer S20157</p>		

BELLOWS 1T19LB8	AON W01-M58-8775	C01-M58-0492	21.26	Aluminum	
<p>CROSS SECTION</p>	<p>3535</p> <p>BEAD PLATE TOP</p>	<p>3808/NAD-17160</p> <p>PISTON BOTTOM</p>	<p>APPLICATIONS: ROR SAF WEWELER 1R14-716</p>		

HARDWARE KEY

- Bolt or Stud 1/2-13
- ⊗ Air Inlet 1/4 N.P.T.
- ⊗ Combination Stud/Air Inlet Stud Outside Thread is 3/4-16 Pistons
- ⊗ Exception to Standard Stud/Air Inlet Stud Inside Thread of 1/4 N.P.T.

- ▲ No Alignment Specified-Center Stud Mounting is Standard
- ⊗ Threaded Hole 3/8-16 Blind Nut on Bead Plates 1/2-13 Pistons

<p>BELLOWS 1T19LB12</p>	<p>AON W01-M58-6348</p>	<p>C01-M58-1163 24.60 Aluminum</p>
<p>CROSS SECTION</p>	<p>2935 BEAD PLATE TOP</p>	<p>4034 / NAD-37991 PISTON BOTTOM Order No. WC1-M58-1655</p>
<p>BELLOWS 1T19LC5</p>	<p>AON W01-358-8092</p>	<p>C01-358-5250 21.40 Aluminum</p>
<p>CROSS SECTION</p>	<p>3506 BEAD PLATE TOP</p>	<p>9766/NAD-28978 PISTON BOTTOM Order No. WC1-358-0631</p>
<p>BELLOWS 1T19LC5</p>	<p>AON W01-M58-8798</p>	<p>C01-M58-5346 14.36 Aluminum</p>
<p>CROSS SECTION</p>	<p>3590 BEAD PLATE TOP</p>	<p>3894/NAD-34318 PISTON BOTTOM</p>
<p>BELLOWS 1T19LC6</p>	<p>AON W01-358-8091</p>	<p>C01-358-5349 17.88 Composite</p>
<p>CROSS SECTION</p>	<p>3318 BEAD PLATE TOP</p>	<p>9594/NAD-28384 PISTON BOTTOM Order No. WC1-358-1614</p>
<p>BELLOWS 1T19LC8</p>	<p>AON W01-358-8093</p>	<p>C01-358-5350 21.17 Composite</p>
<p>CROSS SECTION</p>	<p>3318 BEAD PLATE TOP</p>	<p>9594/NAD-28384 PISTON BOTTOM ORDER NO. WC1-358-1614</p>

APPLICATIONS:

Ag Chem

John Deere AN205761

APPLICATIONS:
Hendrickson Trailer S20901 (Intraux 250)
-Reuse metal disk
Hendrickson Trailer S21784 w/ metal disk for piston support

APPLICATIONS:
Hendrickson Trailer S23748 (w/ disk S24443)

BELLOWS 1T19LE8	AON W01-358-9825	C01-358-0521	22.08	Aluminum	
<p>CROSS SECTION</p>	<p>3388</p> <p>BEAD PLATE TOP</p>	<p>9666/NAD-19631</p> <p>PISTON BOTTOM</p> <p>Order No. N/A</p>	<p>APPLICATIONS: Tuthill Granning 700136-01</p>		

BELLOWS 1T19LE12	AON W01-358-8793	C01-358-0517	22.82	Aluminum	
<p>CROSS SECTION</p>	<p>3388</p> <p>BEAD PLATE TOP</p>	<p>9666/NAD-19631</p> <p>PISTON BOTTOM</p>	<p>APPLICATIONS: Holland (Neway) 90557270 AD-130</p>		

BELLOWS 1T19LF7	AON W01-358-8774	C01-358-0519	18.01	Composite	
<p>CROSS SECTION</p>	<p>3318</p> <p>BEAD PLATE TOP</p>	<p>9594/ NAD-28384</p> <p>PISTON BOTTOM</p> <p>Order No. WC1-358-1614</p>	<p>APPLICATIONS: Hendrickson Trailer S25873 Replacement piston comes without mounting plate Watson & Chalin AS-0159</p>		

BELLOWS 1T19LG8	AON W01-358-5530	C01-358-0562	19.13	Aluminum	
<p>CROSS SECTION</p>	<p>2819</p> <p>BEAD PLATE TOP</p>	<p>9766/NAD-28978</p> <p>PISTON BOTTOM</p>	<p>APPLICATIONS: Neway 90557434</p>		

BELLOWS 1T19ZK5.7	AON W01-358-5523	C01-358-0513	29.20	Steel	
<p>CROSS SECTION</p>	<p>3196</p> <p>BEAD PLATE TOP</p>	<p>9644/NAD-31862</p> <p>PISTON BOTTOM</p>	<p>APPLICATIONS: Hend. Trailer S-4771 Hend Canada B-12514-013 Tuthill-Reyco 23631-01 WatsonChalin AS-0039</p> <p>REPLACES 1T19J6</p>		

HARDWARE KEY

- Bolt or Stud 1/2-13
- ⊗ Air Inlet 1/4 N.P.T.
- ⊙ Combination Stud/Air Inlet Stud Outside Thread is 3/4-16 Pistons
- ⊕ Exception to Standard Stud/Air Inlet Stud Inside Thread of 1/4 N.P.T.

- ▲ No Alignment Specified-Center Stud Mounting is Standard
- ⊕ Threaded Hole 3/8-16 Blind Nut on Bead Plates 1/2-13 Pistons

BELLOWS 1T19ZK5.7	AON W01-358-8050	C01-358-0513	25.00	Aluminum	
<p>CROSS SECTION</p>	<p>2690</p> <p>BEAD PLATE TOP</p>	<p>9640/FIP-101136</p> <p>PISTON BOTTOM</p>	<p>APPLICATIONS: Hendrickson Trailer S4771 Hend. Canada B-12514-013 Tuthill-Reyco 23631-01 Watson & Chalin AS-0039</p> <p>REPLACES 1T19J6</p>		

BELLOWS 1T19ZK5.7	AON W01-358-8052	C01-358-0513	29.55	Steel	
<p>CROSS SECTION</p>	<p>3388</p> <p>BEAD PLATE TOP</p>	<p>9644/NAD-31862</p> <p>Order No. WC1-358-9999</p> <p>PISTON BOTTOM</p>	<p>APPLICATIONS: Hendrickson Can. B12514-012 Watson & Chalin AS-0078 Watson & Chalin AS-0039</p> <p>REPLACES 1T19J6</p>		

BELLOWS 1T19ZK5.7	AON W01-358-8053	C01-358-0513	20.88	Steel	
<p>CROSS SECTION</p>	<p>3395</p> <p>BEAD PLATE TOP</p>	<p>9644/NAD-31862</p> <p>Order No. WC1-358-9999</p> <p>PISTON BOTTOM</p>	<p>APPLICATIONS: Holland (Neway) 90557098 (ARDTB125-6A&6B)</p> <p>REPLACES 1T19J6</p>		

BELLOWS 1T26D7	AON W01-358-9310	C01-358-5147	5.73	Aluminum	
<p>CROSS SECTION</p>	<p>3452</p> <p>BEAD PLATE TOP</p>	<p>9889/NBD-9253</p> <p>1/2-13 UNC-2B x .87 DP.</p> <p>PISTON BOTTOM</p>	<p>APPLICATIONS:</p>		

BELLOWS 1T26D7	AON W01-358-9327	C01-358-5147	5.63	Aluminum	
<p>CROSS SECTION</p>	<p>3450</p> <p>BEAD PLATE TOP</p>	<p>9889/NBD-9253</p> <p>1/2-13 UNC-2B x .87 DP.</p> <p>PISTON BOTTOM</p>	<p>APPLICATIONS:</p>		

BELLOWS 1T66G11.8	AON W01-358-8984	C01-358-0927	35.50	Steel
<p>CROSS SECTION</p>	<p>3295 BEAD PLATE TOP</p>	<p>9461/FIP-101678 PISTON BOTTOM</p>	<p>APPLICATIONS: Wabash (Roadrailer) Rowe Truck ASC1400HL Ride</p> <p>REPLACES 1T19J6</p>	

BELLOWS BRACKET	AON WC1-358-3874	N/A	1.28	N/A
<p>CROSS SECTION</p>	<p>6013/NAD-33041 BEAD PLATE TOP</p>	<p>PISTON BOTTOM</p>	<p>APPLICATIONS: Freightliner 16-17010-001 16-15762-000</p> <p>OBSELETE: NO LONGER AVAILABLE</p>	

BELLOWS BRACKET	AON WC1-358-3876	N/A	1.39	N/A
<p>CROSS SECTION</p>	<p>6012/NAD-33042 BEAD PLATE TOP</p>	<p>PISTON BOTTOM</p>	<p>APPLICATIONS: Freightliner 16-17010-002</p> <p>OBSELETE: NO LONGER AVAILABLE</p>	

BELLOWS BRACKET	AON WC1-358-3900	N/A	1.58	N/A
<p>CROSS SECTION</p>	<p>6033/ NBD-13722 BEAD PLATE TOP</p>	<p>PISTON BOTTOM</p>	<p>APPLICATIONS: Freightliner A16-14004-000 (Aluminum) 9781 Freightliner 16-13810-001 (Plastic) 9780 Add Bracket to 9780 or 9781</p> <p>ORDER NO. N/A</p>	

BELLOWS BRACKET	AON WC1-358-3901	N/A	2.02	N/A
<p>CROSS SECTION</p>	<p>6034/ NBD-13721 BEAD PLATE TOP</p>	<p>PISTON BOTTOM</p>	<p>APPLICATIONS: Freightliner A16-14004-001 (Aluminum) Freightliner 16-13810-002 (Plastic) (Cabover) Add Bracket To 9780 or 9781</p> <p>ORDER NO. N/A</p>	

HARDWARE KEY

- Bolt or Stud 1/2-13
- ⊗ Air Inlet 1/4 N.P.T.
- ⊗ Combination Stud/Air Inlet Stud Outside Thread is 3/4-16 Pistons
- ⊗ Exception to Standard Stud/Air Inlet Stud Inside Thread of 1/4 N.P.T.

- ▲ No Alignment Specified-Center Stud Mounting is Standard
- ⊗ Threaded Hole 3/8-16 Blind Nut on Bead Plates 1/2-13 Pistons

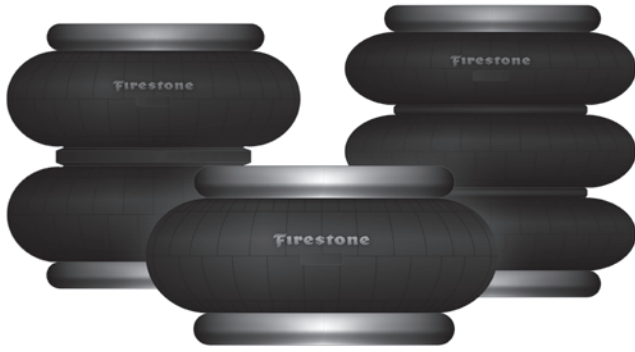

Firestone's convoluted Airide springs are available in three styles—single, double, or triple convoluted.

READING THE PARTS TABLE

1 BELLOWS 218	2 AON W01-358-7294	6 14.6
<p>3</p> <p>CROSS SECTION</p>	<p>4</p> <p>BEAD PLATE TOP</p>	<p>5</p> <p>BEAD PLATE BOTTOM</p>
7 BEAD RING WC1-358-3509		8 APPLICATIONS: Unit Rig 1016031 Dart 21-40061
9 OBSOLETE		

1. Bellows Number

Identifies the bellows, normally molded directly underneath the Firestone logo.

2. Assembly Order Number (AON)

Located on the label adhered to the bead plate. This number is used for ordering purposes.

3. Cross Section View

Includes dimensional information in inches for **uninflated** diameter and collapsed height, as well as hardware details. A bumper, shown in black, and bumper drawing number is also referenced, if applicable (i.e., 6395).

4. Bead Plate Top View

Identifies dimensional information in inches, mounting attachments, and the internal Firestone reference number for bead plate, stamped on bead plate top.

5. Bead Plate Bottom View

Identifies dimensional information in inches, mounting attachments, and the internal Firestone reference number for bead plate, stamped on bead plate bottom.

6. Assembly Weight

Total weight of the assembly in pounds.

7. Assembly Components

Part numbers for sub-components associated with the assembly.

8. Applications

Vehicle and suspension manufacturers' part numbers for the particular Airide spring.

9. Assembly Notes

Important information if an assembly has been obsoleted and if there is an exact replacement part available, or if it has replaced other parts.

AIR SPRING IDENTIFICATION

Convoluted Air Springs

To identify the exact style and part number to replace your current air spring, you need to identify the type of bellows, bead plates, and attaching hardware used, as well as determining whether the spring has an internal bumper. The steps below apply to all convoluted air spring styles (single, double, or triple).

Assembly Order Number (AON) 2

The quickest way to identify the air spring is to read the manufacturer or Firestone assembly order number, located on the label adhered to the bead plate.

Bellows Number 1

If the AON is illegible, read the part number molded on the bellows, normally directly under the Firestone name. If the number (20, 22, etc.) is present, refer to the corresponding bellows range in this guide to narrow down your search.

Bead Plate 4

Identify the 8-digit stamped bead plate number. Reference the last 4 digits to find possible matches. If the number is not legible, use the **bead plate diameter** measurement in this view to further distinguish between assemblies. Verify the alignment of mounting attachments.

Air Spring Hardware 3

To complete the parts identification, compare the metal bead plates and attaching hardware with the assemblies detailed in that same section of the guide. See illustrations below.

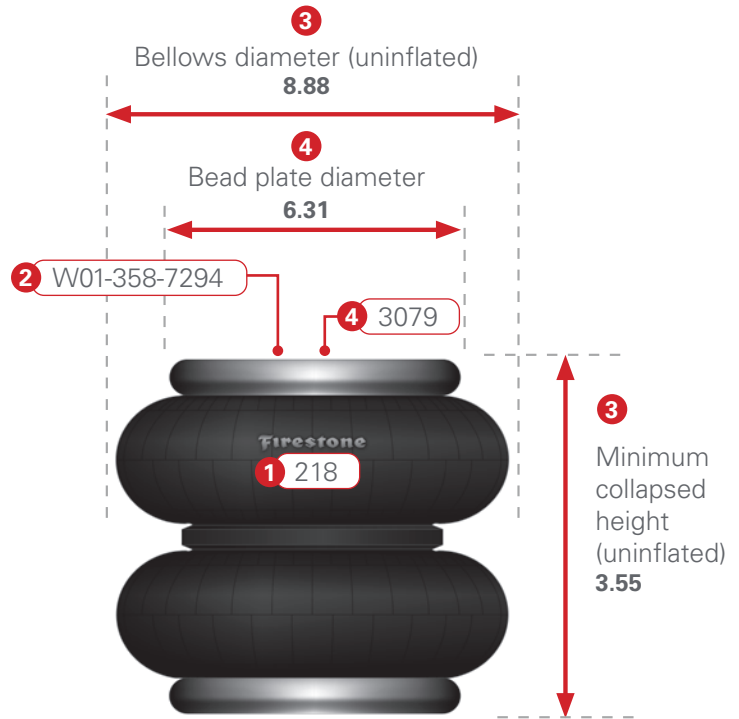

Measure and Reference Cross Section View 3

Should the bellows number be unreadable, you can determine the bellows type with two simple measurements. Open the air entrance and allow the bellows to assume its normal shape. Then, **measure the bead plate diameter** and **outer diameter of the bellows**. Compare these diameters with those listed in the bellows index (page 216) for the specific type of convoluted (single, double, or triple) bellows that you have. To determine if an **internal bumper** is present, measure the minimum collapsed height and compare it to the parts table.

BEAD RING-TYPE PART

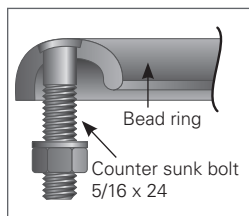

COMBINATION STUD - AIR FITTING

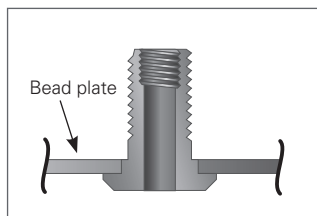

STANDARD BOLT OR STUD

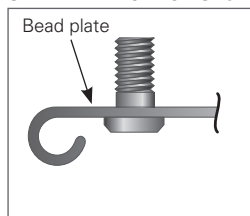

AIR FITTING

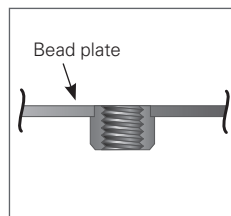

TAPPED HOLE (BLIND NUT)

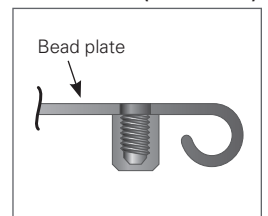

BELLOWS 16	AON W01-358-0510	📦 2.60
	<p>APPLICATIONS:</p>	

BELLOWS 16	AON W01-358-7001	📦 2.57
	<p>APPLICATIONS:</p>	

BELLOWS 19	AON W01-358-6994	📦 11.42
	<p>APPLICATIONS: Capacity of Texas</p>	

BELLOWS 19	AON W01-358-7008	📦 9.60
	<p>APPLICATIONS: Holland (Neway) 90557226</p>	

BELLOWS 19	AON W01-358-7009	📦 11.16
	<p>APPLICATIONS: Holland (Neway) 90557002</p>	

- HARDWARE KEY**
- Bolt or Stud 1/2-13
 - ⊗ Air Inlet 1/4 N.P.T.
 - ⊙ Combination Stud/Air Inlet Stud Outside Thread is 3/4-16 Pistons
 - ⊕ Exception to Standard Stud/Air Inlet Stud Inside Thread of 1/4 N.P.T.

- ▲ No Alignment Specified-Center Stud Mounting is Standard
- ⊕ Threaded Hole 3/8-16 Blind Nut on Bead Plates 1/2-13 Pistons

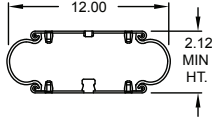
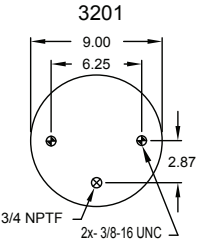
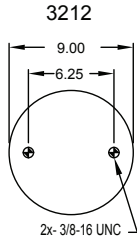
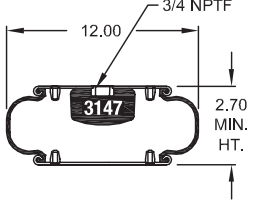
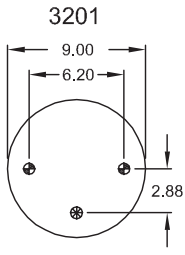
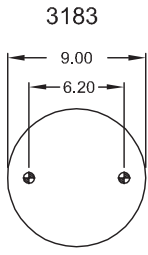
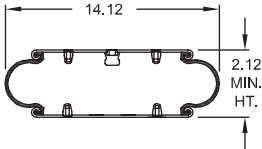
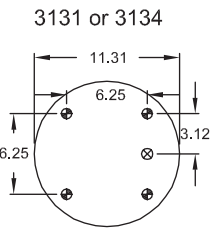
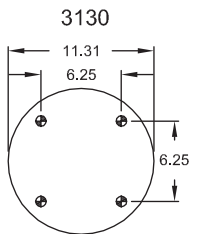
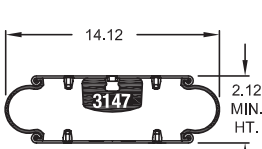
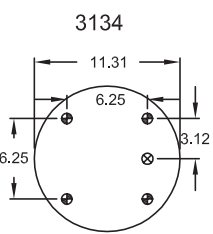
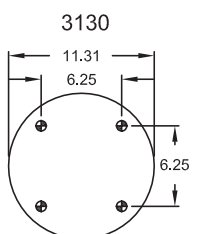
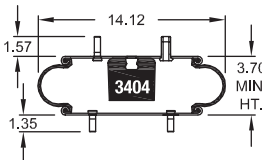
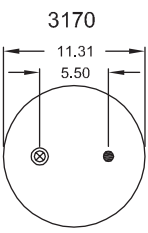
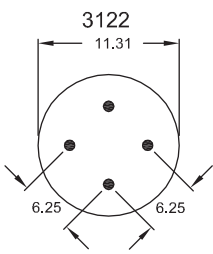
<p>BELLOWS 19</p>	<p>AON W01-358-7011</p>	<p>9.92</p>
 <p>CROSS SECTION</p>	 <p>3201 BEAD PLATE TOP</p>  <p>3212 BEAD PLATE BOTTOM</p>	<p>APPLICATIONS:</p>
<p>BELLOWS 19-.75</p>	<p>AON W01-358-7043</p>	<p>11.22</p>
 <p>CROSS SECTION</p>	 <p>3201 BEAD PLATE TOP</p>  <p>3183 BEAD PLATE BOTTOM</p>	<p>APPLICATIONS: Chalmers</p> <p>OBSOLETE: NO LONGER AVAILABLE</p>
<p>BELLOWS 113</p>	<p>AON W01-358-7103</p>	<p>14.11</p>
 <p>CROSS SECTION</p>	 <p>3131 or 3134 BEAD PLATE TOP</p>  <p>3130 BEAD PLATE BOTTOM</p>	<p>APPLICATIONS: Peerless 0550-00015</p>
<p>BELLOWS 113</p>	<p>AON W01-358-7104</p>	<p>15.38</p>
 <p>CROSS SECTION</p>	 <p>3134 BEAD PLATE TOP</p>  <p>3130 BEAD PLATE BOTTOM</p>	<p>APPLICATIONS: Miscellaneous</p> <p>OBSOLETE: NO LONGER AVAILABLE</p>
<p>BELLOWS 113-.5</p>	<p>AON W01-358-7093</p>	<p>16.71</p>
 <p>CROSS SECTION</p>	 <p>3170 BEAD PLATE TOP</p>  <p>3122 BEAD PLATE BOTTOM</p>	<p>APPLICATIONS: American Carrier 8003-013</p>

BELLOWS 113-1	AON W01-358-7094	🔒 16.41	
<p>CROSS SECTION</p>	<p>3135 BEAD PLATE TOP</p>	<p>3130 BEAD PLATE BOTTOM</p>	<p>APPLICATIONS: Chalmers</p>

BELLOWS 113-1	AON W01-358-7112	🔒 14.96	
<p>CROSS SECTION</p>	<p>3123/3132 BEAD PLATE TOP</p>	<p>3122 BEAD PLATE BOTTOM</p>	<p>APPLICATIONS: Holland (Neway) 90557028 Ridewell 1003587112C</p>

BELLOWS 126	AON W01-358-7726	🔒 43.62	
<p>CROSS SECTION</p>	<p>3473 BEAD PLATE TOP</p>	<p>3474 BEAD PLATE BOTTOM</p>	<p>APPLICATIONS: Air Suspended Fifth Wheel Tartan Transportation (Classic Ride)/Airglide</p>







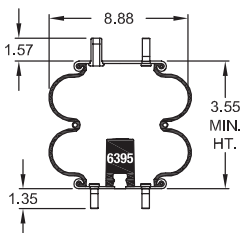
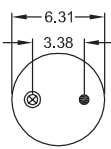
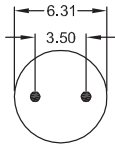

BELLOWS 150	AON W01-358-7462	🔒 6.28	
<p>CROSS SECTION</p>	<p>3079 BEAD PLATE TOP</p>	<p>3100 BEAD PLATE BOTTOM</p>	<p>APPLICATIONS: Load Share</p>

BELLOWS 20	AON W01-358-6856	🔒 8.06	
<p>CROSS SECTION</p>	<p>3079 BEAD PLATE TOP</p>	<p>3100 BEAD PLATE BOTTOM</p>	<p>APPLICATIONS: Tuthill Granning 702932-01</p>

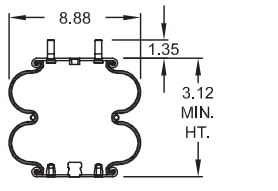
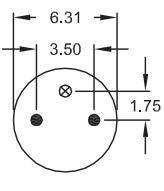
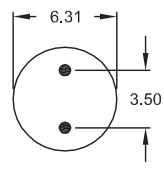
HARDWARE KEY

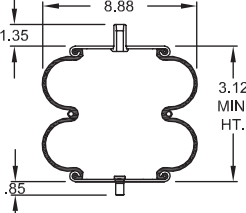
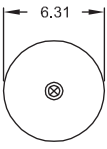
- Bolt or Stud 1/2-13
- ⊗ Air Inlet 1/4 N.P.T.
- ⊗ Combination Stud/Air Inlet Stud Outside Thread is 3/4-16 Pistons
- ⊗ Exception to Standard Stud/Air Inlet Stud Inside Thread of 1/4 N.P.T.

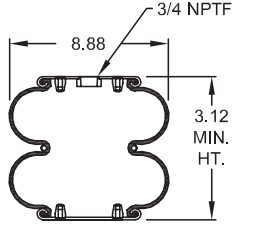
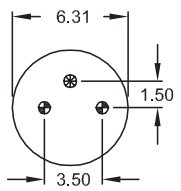
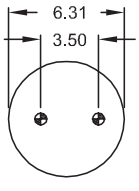
- ▲ No Alignment Specified-Center Stud Mounting is Standard
- ⊗ Threaded Hole 3/8-16 Blind Nut on Bead Plates 1/2-13 Pistons

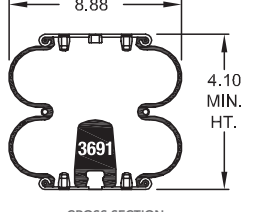
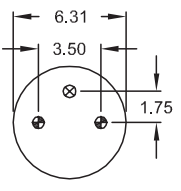
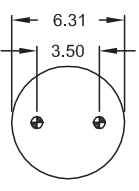
BELLOWS 20	AON W01-358-6884	 8.28
 <p>CROSS SECTION</p>	<p>3148</p>  <p>BEAD PLATE TOP</p> <p>3099</p>  <p>BEAD PLATE BOTTOM</p>	<p>APPLICATIONS: Link 1103-0019</p>
BELLOWS 20	AON W01-358-6890	 7.27
 <p>CROSS SECTION</p>	<p>3101</p>  <p>BEAD PLATE TOP</p> <p>3090</p>  <p>BEAD PLATE BOTTOM</p>	<p>APPLICATIONS: Holland (Neway) 90557228 V-Steer 1 (Lift Bag)</p>
BELLOWS 20	AON W01-358-6897	 7.33
 <p>CROSS SECTION</p>	<p>3102</p>  <p>BEAD PLATE TOP</p> <p>3084</p>  <p>BEAD PLATE BOTTOM</p>	<p>APPLICATIONS: Watson & Chalin AS-0058</p>
BELLOWS 20	AON W01-358-6900	 7.09
 <p>CROSS SECTION</p>	<p>3096</p>  <p>BEAD PLATE TOP</p> <p>3090</p>  <p>BEAD PLATE BOTTOM</p>	<p>APPLICATIONS: Ridewell</p>
BELLOWS 20	AON W01-358-6902	 8.29
 <p>CROSS SECTION</p>	<p>3079</p>  <p>BEAD PLATE TOP</p> <p>3100</p>  <p>BEAD PLATE BOTTOM</p>	<p>APPLICATIONS: Granning 4848 Hendrickson Trailer S2630 R & S Truck & Body 1027505 Ridewell 1003586902C American Carrier Suspensions Inc. 2000-42 Watson & Chalin AS-0002</p>

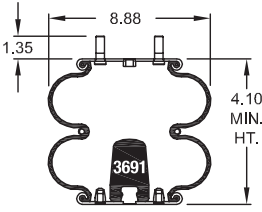
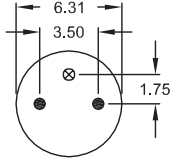
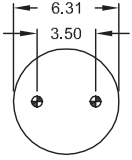
BELLOWS 20	AON W01-358-6905	📦 8.53	
 <p>CROSS SECTION</p>	<p>3101</p>  <p>BEAD PLATE TOP</p>	<p>3100</p>  <p>BEAD PLATE BOTTOM</p>	<p>APPLICATIONS: Hendrickson Trailer S3518 Hendrickson Trailer S5270 Hendrickson Can. 45843-1 Ridewell 1003586905C Silent Drive EZ Ride 8030120 Monaco Coach Watson & Chalin AS-0020</p>

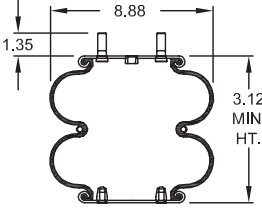
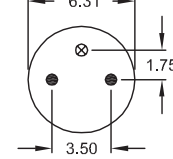
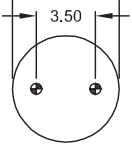
BELLOWS 20	AON W01-358-6908	📦 7.82	
 <p>CROSS SECTION</p>	<p>3101</p>  <p>BEAD PLATE TOP</p>	<p>3090</p>  <p>BEAD PLATE BOTTOM</p>	<p>APPLICATIONS: Watson & Chalin AS-0035</p>

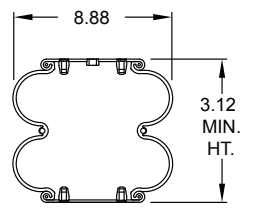
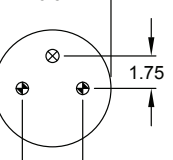
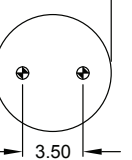
BELLOWS 20	AON W01-358-6910	📦 7.00	
 <p>CROSS SECTION</p>	<p>3079</p>  <p>BEAD PLATE TOP</p>	<p>3090</p>  <p>BEAD PLATE BOTTOM</p>	<p>APPLICATIONS: Granning 1371 Hendrickson Trailer S8768 Hendrickson Can. 45843-3 Ridewell 1003586910C Watson & Chalin AS-0001</p>

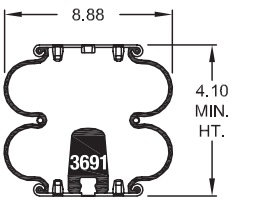
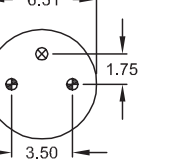
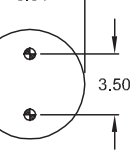
BELLOWS 20	AON W01-358-6926	📦 8.02	
 <p>CROSS SECTION</p>	<p>3079</p>  <p>BEAD PLATE TOP</p>	<p>3100</p>  <p>BEAD PLATE BOTTOM</p>	<p>APPLICATIONS: Load Share</p>

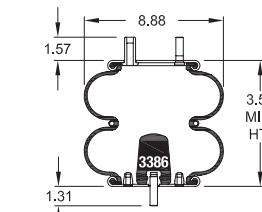
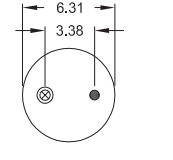
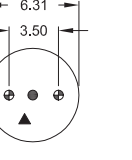
BELLOWS 20	AON W01-358-6932	📦 8.36	
 <p>CROSS SECTION</p>	<p>3148</p>  <p>BEAD PLATE TOP</p>	<p>3095</p>  <p>BEAD PLATE BOTTOM</p>	<p>APPLICATIONS: Ridewell 1003586932C</p>

HARDWARE KEY

- Bolt or Stud 1/2-13
- ⊗ Air Inlet 1/4 N.P.T.
- ⊙ Combination Stud/Air Inlet Stud Outside Thread is 3/4-16 Pistons
- ⊕ Exception to Standard Stud/Air Inlet Stud Inside Thread of 1/4 N.P.T.

- ▲ No Alignment Specified-Center Stud Mounting is Standard
- ⊕ Threaded Hole 3/8-16 Blind Nut on Bead Plates 1/2-13 Pistons

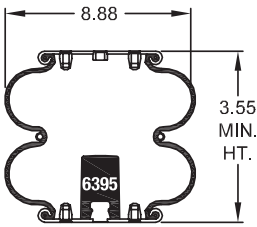
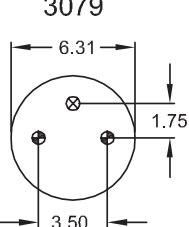
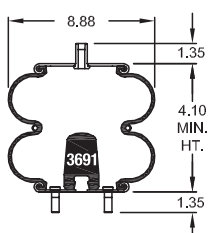
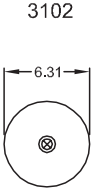
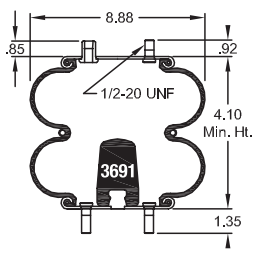
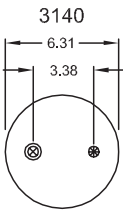
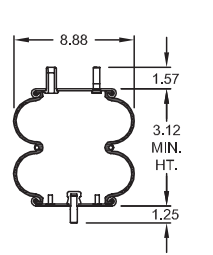
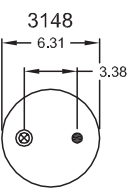
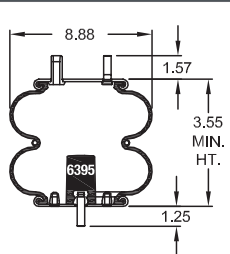
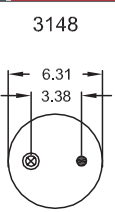
<p>BELLOWS 20</p>	<p>AON W01-358-6935</p>	<p>7.95</p>
 <p>CROSS SECTION</p>	 <p>BEAD PLATE TOP</p>	<p>APPLICATIONS: Hendrickson Trailer S14318 HLM Lift Bag Hendrickson Aux. 003318 (metric version)</p>
<p>BELLOWS 20</p>	<p>AON W01-358-6940</p>	<p>8.58</p>
 <p>CROSS SECTION</p>	 <p>BEAD PLATE TOP</p>	<p>APPLICATIONS: Histeer 10305</p>
<p>BELLOWS 20</p>	<p>AON W01-358-6941</p>	<p>8.31</p>
 <p>CROSS SECTION</p>	 <p>BEAD PLATE TOP</p>	<p>APPLICATIONS: Histeer 10302</p>
<p>BELLOWS 20</p>	<p>AON W01-358-6949</p>	<p>7.90</p>
 <p>CROSS SECTION</p>	 <p>BEAD PLATE TOP</p>	<p>APPLICATIONS: Load Air P-10872-A</p>
<p>BELLOWS 20</p>	<p>AON W01-358-7686</p>	<p>8.86</p>
 <p>CROSS SECTION</p>	 <p>BEAD PLATE TOP</p>	<p>APPLICATIONS: Rowe Truck 0035 ASC2500 ASC1600</p>

AUXILIARY / TAG AXLE

<p>BELLOWS 20</p>	<p>AON W01-358-7788</p>	<p>8.63</p>
<p>CROSS SECTION</p>	<p>BEAD PLATE TOP</p>	<p>BEAD PLATE BOTTOM</p> <p>APPLICATIONS: Watson & Chalin AS-0088</p>
<p>BELLOWS 20</p>	<p>AON W01-358-7795</p>	<p>7.31</p>
<p>CROSS SECTION</p>	<p>BEAD PLATE TOP</p>	<p>BEAD PLATE BOTTOM</p> <p>APPLICATIONS: Hendrickson Trailer S14486 (lift bag) Hendrickson Aux. (Paralift, Paralift Ultra) Hendrickson Aux. 003317 (metric version)</p>
<p>BELLOWS 20</p>	<p>AON W01-358-7891</p>	<p>7.90</p>
<p>CROSS SECTION</p>	<p>BEAD PLATE TOP</p>	<p>BEAD PLATE BOTTOM</p> <p>APPLICATIONS: Hendrickson 5360</p>
<p>BELLOWS 20</p>	<p>AON W01-358-7892</p>	<p>7.98</p>
<p>CROSS SECTION</p>	<p>BEAD PLATE TOP</p>	<p>BEAD PLATE BOTTOM</p> <p>APPLICATIONS: Ridewell 1003587893C</p>
<p>BELLOWS 20-1</p>	<p>AON W01-358-6883</p>	<p>8.26</p>
<p>CROSS SECTION</p>	<p>BEAD PLATE TOP</p>	<p>BEAD PLATE BOTTOM</p> <p>APPLICATIONS: Watson & Chalin AS-0092</p>



HARDWARE KEY

- Bolt or Stud 1/2-13
- ⊗ Air Inlet 1/4 N.P.T.
- ⊗ Combination Stud/Air Inlet Stud Outside Thread is 3/4-16 Pistons
- ⊗ Exception to Standard Stud/Air Inlet Stud Inside Thread of 1/4 N.P.T.

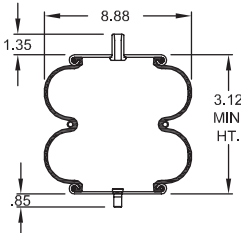
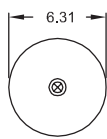
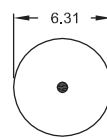
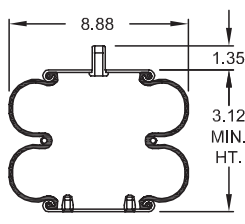
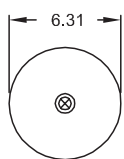
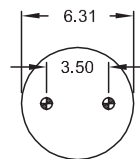
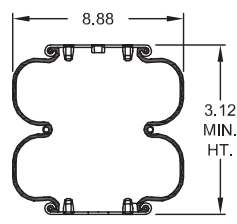
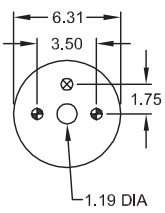
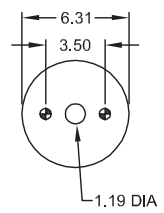
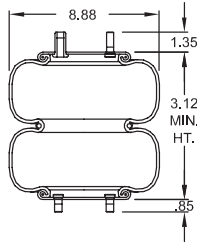
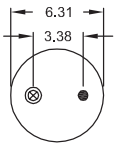
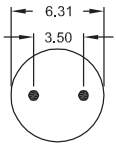
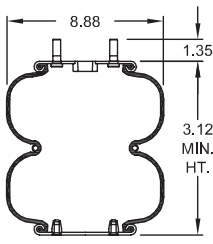
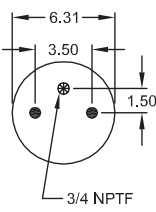
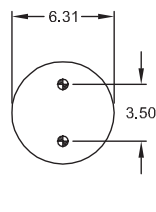
- ▲ No Alignment Specified-Center Stud Mounting is Standard
- ⊗ Threaded Hole 3/8-16 Blind Nut on Bead Plates 1/2-13 Pistons

<p>BELLOWS 20-1</p>	<p>AON W01-358-6886</p>	<p>8.06</p>
 <p>CROSS SECTION</p>	<p>3102</p>  <p>BEAD PLATE TOP</p> <p>3084</p>  <p>BEAD PLATE BOTTOM</p>	<p>APPLICATIONS: Watson & Chalin AS-0058-1F Tuthill-Reyco 701784-01</p>
<p>BELLOWS 20-1</p>	<p>AON W01-358-7897</p>	<p>7.57</p>
 <p>CROSS SECTION</p>	<p>3102</p>  <p>BEAD PLATE TOP</p> <p>3090</p>  <p>BEAD PLATE BOTTOM</p>	<p>APPLICATIONS: Hendrickson Aux. 002878 (Lift Bag) Hendrickson Aux. (Pararev) Hendrickson Trailer S23114</p>
<p>BELLOWS 20-2</p>	<p>AON W01-358-5900</p>	<p>7.74</p>
 <p>CROSS SECTION</p>	<p>3048</p>  <p>BEAD PLATE TOP</p> <p>3047</p>  <p>BEAD PLATE BOTTOM</p>	<p>APPLICATIONS: Link 1103-0059</p>
<p>BELLOWS 20-2</p>	<p>AON W01-358-6392</p>	<p>8.28</p>
 <p>CROSS SECTION</p>	<p>3349</p>  <p>BEAD PLATE TOP</p> <p>3367</p>  <p>BEAD PLATE BOTTOM</p>	<p>APPLICATIONS: Arvin Meritor 2258-G-1489</p>
<p>BELLOWS 20-2</p>	<p>AON W01-358-6817</p>	<p>8.09</p>
 <p>CROSS SECTION</p>	<p>3085</p>  <p>BEAD PLATE TOP</p> <p>3090</p>  <p>BEAD PLATE BOTTOM</p>	<p>APPLICATIONS: Ridewell 1003586817C</p>

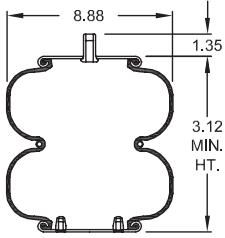
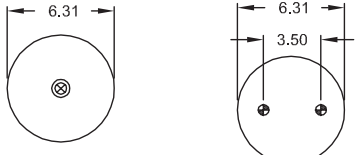
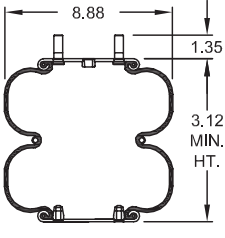
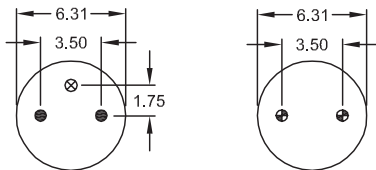
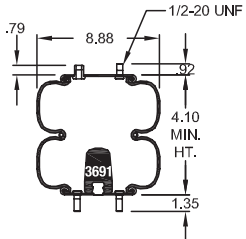
AUXILIARY / TAG AXLE

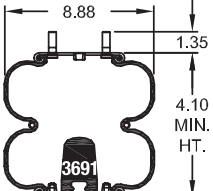
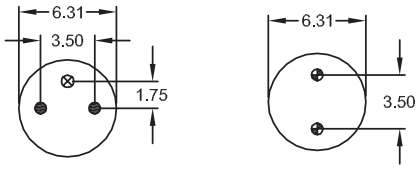
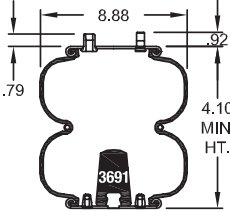
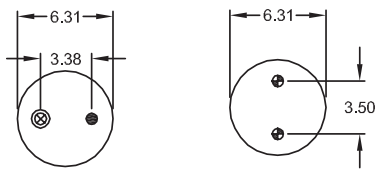
<p>BELLOWS 20-2</p>  <p>CROSS SECTION</p>	<p>AON W01-358-6927</p> <p>3102 3090</p>  <p>BEAD PLATE TOP BEAD PLATE BOTTOM</p>	<p>8.02</p> <p>APPLICATIONS: Reyco 12906-01</p>
<p>BELLOWS 20-2</p>  <p>CROSS SECTION</p>	<p>AON W01-358-6943</p> <p>3101 3090</p>  <p>BEAD PLATE TOP BEAD PLATE BOTTOM</p>	<p>7.98</p> <p>APPLICATIONS: Watson & Chalin AS-0041 Van Raden Holland (Neway) 90557237 V-Steer II (Lift Bag)</p>
<p>BELLOWS 20-2</p>  <p>CROSS SECTION</p>	<p>AON W01-358-6944</p> <p>3140 3099</p>  <p>BEAD PLATE TOP BEAD PLATE BOTTOM</p>	<p>8.64</p> <p>APPLICATIONS: Histeer 10307 Suspensions Inc.</p>
<p>BELLOWS 20-2</p>  <p>CROSS SECTION</p>	<p>AON W01-358-6945</p> <p>3101 3100</p>  <p>BEAD PLATE TOP BEAD PLATE BOTTOM</p>	<p>8.75</p> <p>APPLICATIONS: Ridewell 1003586945C</p>
<p>BELLOWS 20-2</p>  <p>CROSS SECTION</p>	<p>AON W01-358-6946</p> <p>3140 3100</p>  <p>BEAD PLATE TOP BEAD PLATE BOTTOM</p>	<p>8.84</p> <p>APPLICATIONS: Ridewell 1003586946C</p>

HARDWARE KEY

- Bolt or Stud 1/2-13
- ⊗ Air Inlet 1/4 N.P.T.
- ⊗ Combination Stud/Air Inlet Stud Outside Thread is 3/4-16 Pistons
- ⊗ Exception to Standard Stud/Air Inlet Stud Inside Thread of 1/4 N.P.T.

- ▲ No Alignment Specified-Center Stud Mounting is Standard
- ⊗ Threaded Hole 3/8-16 Blind Nut on Bead Plates 1/2-13 Pistons

<p>BELLOWS 20-2</p>	<p>AON W01-358-6947</p>	<p>8.68</p>
<p>CROSS SECTION</p>	<p>3079</p> <p>BEAD PLATE TOP</p>	<p>3100</p> <p>BEAD PLATE BOTTOM</p> <p>APPLICATIONS: Hendrickson Trailer S8701 Ridewell 1003586947C</p>
<p>BELLOWS 20-2</p>	<p>AON W01-358-6948</p>	<p>8.50</p>
<p>CROSS SECTION</p>	<p>3101</p> <p>BEAD PLATE TOP</p>	<p>3100</p> <p>BEAD PLATE BOTTOM</p> <p>APPLICATIONS: Ridewell 1003586948C Silent Drive</p>
<p>BELLOWS 20-2</p>	<p>AON W01-358-6960</p>	<p>8.39</p>
<p>CROSS SECTION</p>	<p>3101</p> <p>BEAD PLATE TOP</p>	<p>3099</p> <p>BEAD PLATE BOTTOM</p> <p>APPLICATIONS: Granning 7025</p> <p>OBSELETE: NO LONGER AVAILABLE</p>
<p>BELLOWS 20-2</p>	<p>AON W01-358-6962</p>	<p>8.41</p>
<p>CROSS SECTION</p>	<p>3148</p> <p>BEAD PLATE TOP</p>	<p>3100</p> <p>BEAD PLATE BOTTOM</p> <p>APPLICATIONS: Hendrickson Trailer S21323</p> <p>OBSELETE: NO LONGER AVAILABLE</p>
<p>BELLOWS 21</p>	<p>AON W01-358-7123</p>	<p>19.21</p>
<p>CROSS SECTION</p>	<p>3109</p> <p>BEAD PLATE TOP</p>	<p>3167</p> <p>BEAD PLATE BOTTOM</p> <p>APPLICATIONS: Kwik Lok/Todco (Jifflox) 53671</p> <p>REPLACES W01-358-7133</p>

AUXILIARY / TAG AXLE

BELLOWS 21	AON W01-358-7135	🔒 17.50	
<p>CROSS SECTION</p>	<p>3123 or 3132</p> <p>BEAD PLATE TOP</p>	<p>3122</p> <p>BEAD PLATE BOTTOM</p>	<p>APPLICATIONS: Holland (Neway) 90557001 Pezzani AR-21-A Ridewell 1003587135C Silent Drive Truckstell (Marion Mfg.) 63641 Truckstell (Marion Mfg.) 63644 Hendrickson Can. B-12514-014</p>

BELLOWS 21	AON W01-358-7136	🔒 22.09	
<p>CROSS SECTION</p>	<p>3134</p> <p>BEAD PLATE TOP</p>	<p>3130</p> <p>BEAD PLATE BOTTOM</p>	<p>APPLICATIONS: Fargo Trailer Granning 1626 Hendrickson Trailer S1080 R & S Truck & Body 1027556 Ridewell 1003587136C Watson & Chalin AS-0004</p>

BELLOWS 21	AON W01-358-7140	🔒 22.73	
<p>CROSS SECTION</p>	<p>3132</p> <p>BEAD PLATE TOP</p>	<p>3122</p> <p>BEAD PLATE BOTTOM</p>	<p>APPLICATIONS: Granning 1015 Hendrickson Trailer S3184 Porcupine (replaces 7142) R & S Truck & Body 1090214 Ridewell 1003587140C Temisko Watson & Chalin AS-0008</p>

BELLOWS 21	AON W01-358-7145	🔒 17.23	
<p>CROSS SECTION</p>	<p>3131</p> <p>BEAD PLATE TOP</p>	<p>3130</p> <p>BEAD PLATE BOTTOM</p>	<p>APPLICATIONS: Mack 57QL239 Ridewell 1003587145C Volvo/GM-Heavy Duty Truck 35203-0005</p>

BELLOWS 21	AON W01-358-7146	🔒 20.44	
<p>CROSS SECTION</p>	<p>3134</p> <p>BEAD PLATE TOP</p>	<p>3130</p> <p>BEAD PLATE BOTTOM</p>	<p>APPLICATIONS: American Carrier 8003-005 EZ Ride Holland (Neway) 90557039 Ridewell 1003587146C Willmar Gallenberg Mod. Flow Equip.</p>

HARDWARE KEY

- Bolt or Stud 1/2-13
- ⊗ Air Inlet 1/4 N.P.T.
- ⊗ Combination Stud/Air Inlet Stud Outside Thread is 3/4-16 Pistons
- ⊗ Exception to Standard Stud/Air Inlet Stud Inside Thread of 1/4 N.P.T.

▲ No Alignment Specified-Center Stud Mounting is Standard
 ⊕ Threaded Hole 3/8-16 Blind Nut on Bead Plates 1/2-13 Pistons

<p>BELLOWS 21</p>	<p>AON W01-358-8171</p>	<p>18.07</p>
<p>CROSS SECTION</p>	<p>3317 BEAD PLATE TOP</p> <p>3398 BEAD PLATE BOTTOM</p>	<p>APPLICATIONS: Arvin Meritor A-2258-A-1457 RPH-11</p>
<p>BELLOWS 21-2</p>	<p>AON W01-358-6800</p>	<p>17.56</p>
<p>CROSS SECTION</p>	<p>3131 or 3134 BEAD PLATE TOP</p> <p>3130 BEAD PLATE BOTTOM</p>	<p>APPLICATIONS: Watson & Chalin AS-0034 (see W01-358-6808)</p>
<p>BELLOWS 21-2</p>	<p>AON W01-358-6801</p>	<p>23.15</p>
<p>CROSS SECTION</p>	<p>3134 BEAD PLATE TOP</p> <p>3130 BEAD PLATE BOTTOM</p>	<p>APPLICATIONS: EZ Ride 8030160 Hendrickson Trailer S2734 Ridewell 1003586801C Watson & Chalin AS-0021</p>
<p>BELLOWS 21-2</p>	<p>AON W01-358-6802</p>	<p>17.61</p>
<p>CROSS SECTION</p>	<p>3129 BEAD PLATE TOP</p> <p>3130 BEAD PLATE BOTTOM</p>	<p>APPLICATIONS:</p>
<p>BELLOWS 21-2</p>	<p>AON W01-358-6803</p>	<p>21.37</p>
<p>CROSS SECTION</p>	<p>3193 BEAD PLATE TOP</p> <p>3122 BEAD PLATE BOTTOM</p>	<p>APPLICATIONS: Hendrickson Trailer S6412</p> <p>OBSOLETE: NO LONGER AVAILABLE</p>







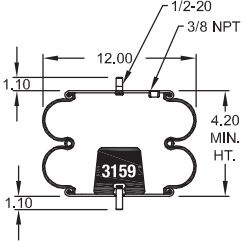
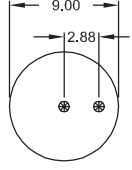

AUXILIARY / TAG AXLE

<p>BELLOWS 21-2</p>	<p>AON W01-358-6805</p>	<p> 20.74</p>
<p>CROSS SECTION</p>	<p>BEAD PLATE TOP</p>	<p>APPLICATIONS: Ridewell 1003586805C</p>
<p>BELLOWS 21-2</p>	<p>AON W01-358-6808</p>	<p> 21.20</p>
<p>CROSS SECTION</p>	<p>BEAD PLATE TOP</p>	<p>APPLICATIONS: Watson & Chalin AS-0034 Holland (Neway) (replaced by 6799)</p>
<p>BELLOWS 21-2</p>	<p>AON W01-358-9529</p>	<p> 17.57</p>
<p>CROSS SECTION</p>	<p>BEAD PLATE TOP</p>	<p>APPLICATIONS:</p>
<p>BELLOWS 22</p>	<p>AON W01-358-7180</p>	<p> 12.00</p>
<p>CROSS SECTION</p>	<p>BEAD PLATE TOP</p>	<p>APPLICATIONS: EZ Ride 8030190 Hendrickson Kwiklok/Todco (Jifflox) Peerless 0550-00001 Talbert Ridewell 1003587180C</p>
<p>BELLOWS 22</p>	<p>AON W01-358-7181</p>	<p> 12.37</p>
<p>CROSS SECTION</p>	<p>BEAD PLATE TOP</p>	<p>APPLICATIONS: Fruehauf UAB-5620 Fruehauf UCC-3054-1</p> <p>OBSELETE: NO LONGER AVAILABLE</p>

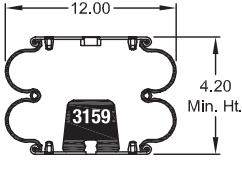
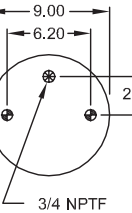
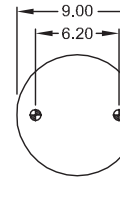
HARDWARE KEY

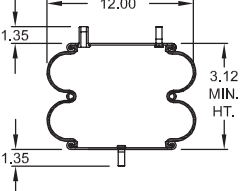
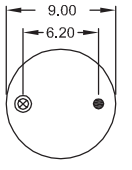
- Bolt or Stud 1/2-13
- ⊗ Air Inlet 1/4 N.P.T.
- ⊗ Combination Stud/Air Inlet Stud Outside Thread is 3/4-16 Pistons
- ⊗ Exception to Standard Stud/Air Inlet Stud Inside Thread of 1/4 N.P.T.

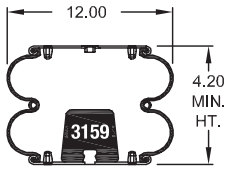
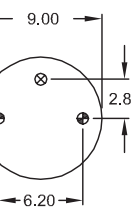
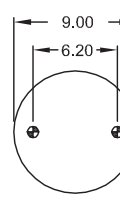
- ▲ No Alignment Specified-Center Stud Mounting is Standard
- ⊗ Threaded Hole 3/8-16 Blind Nut on Bead Plates 1/2-13 Pistons

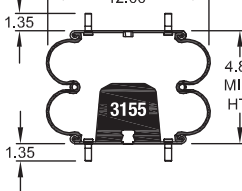
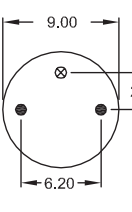
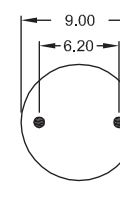
BELLOWS 22	AON W01-358-7183	 14.35
 <p>CROSS SECTION</p>	<div style="display: flex; justify-content: space-around;"> <div data-bbox="553 218 683 491"> <p>3255</p>  <p>BEAD PLATE TOP</p> </div> <div data-bbox="688 218 927 491"> <p>3265</p>  <p>BEAD PLATE BOTTOM</p> </div> </div>	<p>APPLICATIONS: Fruehauf UCA-0112 Fruehauf UCA-0112-B</p>
BELLOWS 22	AON W01-358-7185	 14.38
 <p>CROSS SECTION</p>	<div style="display: flex; justify-content: space-around;"> <div data-bbox="553 581 683 854"> <p>3201</p>  <p>BEAD PLATE TOP</p> </div> <div data-bbox="688 581 927 854"> <p>3183</p>  <p>BEAD PLATE BOTTOM</p> </div> </div>	<p>APPLICATIONS: Chalmers</p>
BELLOWS 22	AON W01-358-7344	 12.34
 <p>CROSS SECTION</p>	<div style="display: flex; justify-content: space-around;"> <div data-bbox="553 945 683 1218"> <p>3271</p>  <p>BEAD PLATE TOP</p> </div> <div data-bbox="688 945 927 1218"> <p>3163</p>  <p>BEAD PLATE BOTTOM</p> </div> </div>	<p>APPLICATIONS: Load Air P10-755C Sauer P10-755C</p>
BELLOWS 22	AON W01-358-7400	 13.89
 <p>CROSS SECTION</p>	<div style="display: flex; justify-content: space-around;"> <div data-bbox="553 1308 683 1581"> <p>3215</p>  <p>BEAD PLATE TOP</p> </div> <div data-bbox="688 1308 927 1581"> <p>3183</p>  <p>BEAD PLATE BOTTOM</p> </div> </div>	<p>APPLICATIONS: Fab Tek 04-0080 Freightliner 16-10769-000 GMC 693230 Granning 2726 Hendrickson Trailer S1013 Holland (Neway) 90557016 R & S Truck & Body 1027519 Ridewell 1003587400C</p>
BELLOWS 22	AON W01-358-7401	 15.86
 <p>CROSS SECTION</p>	<div style="display: flex; justify-content: space-around;"> <div data-bbox="553 1671 683 1944"> <p>3220</p>  <p>BEAD PLATE TOP</p> </div> <div data-bbox="688 1671 927 1944"> <p>3256</p>  <p>BEAD PLATE BOTTOM</p> </div> </div>	<p>APPLICATIONS: GMC 711954 GMC 2076095 Volvo/GM Heavy Duty Truck 2076095 Watson & Chalin AS-0014</p>

BELLOWS 22	AON W01-358-7403	🔒 14.38	
<p>CROSS SECTION</p>	<p>3210</p> <p>BEAD PLATE TOP</p>	<p>3183</p> <p>BEAD PLATE BOTTOM</p>	<p>APPLICATIONS: Granning 2725 Hendrickson Trailer S1159 Hendrickson Trailer S2883 Hendrickson Can. B-12514-001 R & S Truck & Body 1040201 Ridewell 1003587403C Watson & Chalin AS-0007</p>

BELLOWS 22	AON W01-358-7404	🔒 12.33	
<p>CROSS SECTION</p>	<p>3210</p> <p>BEAD PLATE TOP</p>	<p>3183</p> <p>BEAD PLATE BOTTOM</p>	<p>APPLICATIONS: Hendrickson Trailer S5468 Hendrickson Can. S1345 (replaced by 7472)</p>

BELLOWS 22	AON W01-358-7405	🔒 14.34	
<p>CROSS SECTION</p>	<p>3235</p> <p>BEAD PLATE TOP</p>	<p>3256</p> <p>BEAD PLATE BOTTOM</p>	<p>APPLICATIONS: Hutchens H-10384-01 Suspensions Inc.</p>

BELLOWS 22	AON W01-358-7408	🔒 14.22	
<p>CROSS SECTION</p>	<p>3210</p> <p>BEAD PLATE TOP</p>	<p>3183</p> <p>BEAD PLATE BOTTOM</p>	<p>APPLICATIONS: EZ Ride</p> <p style="color: red;">OBSELETE: NO LONGER AVAILABLE</p>

BELLOWS 22	AON W01-358-7409	🔒 14.27	
<p>CROSS SECTION</p>	<p>3271</p> <p>BEAD PLATE TOP</p>	<p>3256</p> <p>BEAD PLATE BOTTOM</p>	<p>APPLICATIONS: Fruehauf</p>

HARDWARE KEY

- Bolt or Stud 1/2-13
- ⊗ Air Inlet 1/4 N.P.T.
- ⊙ Combination Stud/Air Inlet Stud Outside Thread is 3/4-16 Pistons
- ⊕ Exception to Standard Stud/Air Inlet Stud Inside Thread of 1/4 N.P.T.

- ▲ No Alignment Specified-Center Stud Mounting is Standard
- ⊕ Threaded Hole 3/8-16 Blind Nut on Bead Plates 1/2-13 Pistons

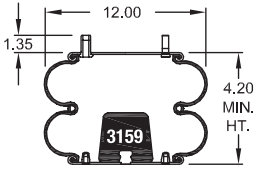
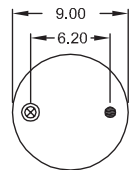
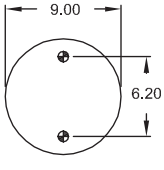
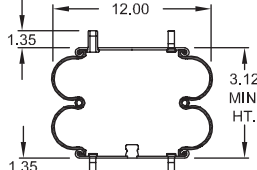
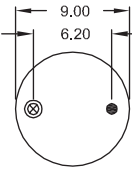
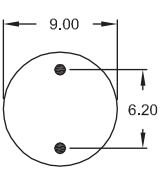
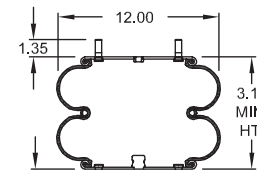
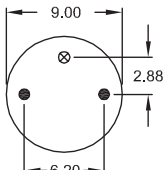
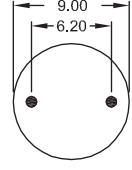
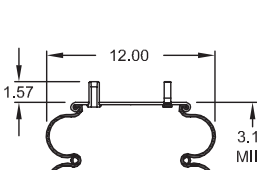
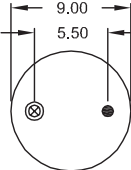
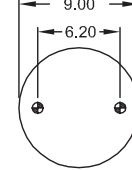
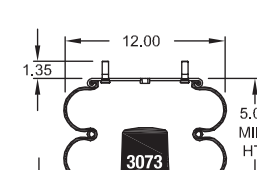
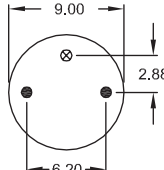
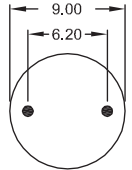
<p>BELLOWS 22</p>	<p>AON W01-358-7410</p>	<p>13.94</p>
 <p>CROSS SECTION</p>	<p>3271</p>  <p>BEAD PLATE TOP</p> <p>3183</p>  <p>BEAD PLATE BOTTOM</p>	<p>APPLICATIONS: Freightliner 16-11378-000</p>
<p>BELLOWS 22</p>	<p>AON W01-358-7423</p>	<p>12.46</p>
 <p>CROSS SECTION</p>	<p>3271</p>  <p>BEAD PLATE TOP</p> <p>3256</p>  <p>BEAD PLATE BOTTOM</p>	<p>APPLICATIONS: Sauer P10-784</p>
<p>BELLOWS 22</p>	<p>AON W01-358-7424</p>	<p>12.51</p>
 <p>CROSS SECTION</p>	<p>3220</p>  <p>BEAD PLATE TOP</p> <p>3256</p>  <p>BEAD PLATE BOTTOM</p>	<p>APPLICATIONS: Intergrated Holland (Neway) 90557014 (AL-41 & 45) Porcupine R & S Truck & Body 1090215 Sauer P10-755</p>
<p>BELLOWS 22</p>	<p>AON W01-358-7429</p>	<p>12.50</p>
 <p>CROSS SECTION</p>	<p>3235</p>  <p>BEAD PLATE TOP</p> <p>3212 OR 3183</p>  <p>BEAD PLATE BOTTOM</p>	<p>APPLICATIONS: Kwik Lok/Todco (Jifflox) CP-5223 Silent Drive</p>
<p>BELLOWS 22</p>	<p>AON W01-358-7437</p>	<p>14.82</p>
 <p>CROSS SECTION</p>	<p>3220</p>  <p>BEAD PLATE TOP</p> <p>3256</p>  <p>BEAD PLATE BOTTOM</p>	<p>APPLICATIONS: Holland (Neway) 90557015 Ridewell 1003587437C</p>

AUXILIARY / TAG AXLE

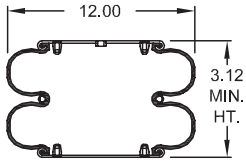
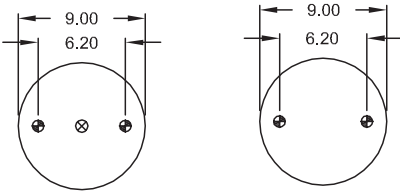
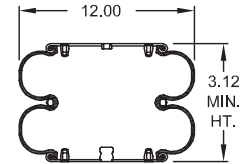
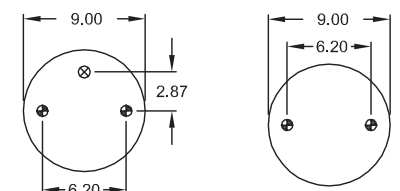
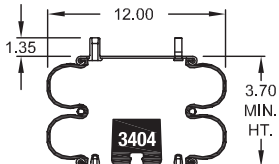
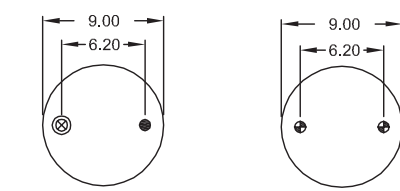
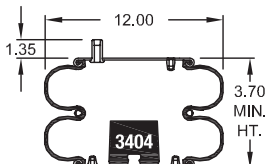
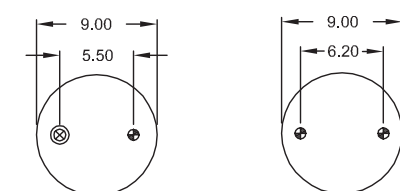
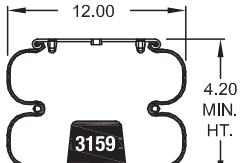
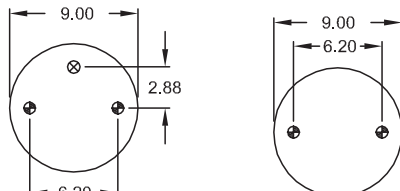
<p>BELLOWS 22-1.5</p>  <p>CROSS SECTION</p>	<p>AON W01-358-7443</p> <p>3208 3212 or 3183</p>  <p>BEAD PLATE TOP BEAD PLATE BOTTOM</p>	<p>12.69</p> <p>APPLICATIONS: Granning 1218 (replaces 7416) Watson & Chalin AS-0027 (replaces 7416) Ridewell 1003587443C</p>
<p>BELLOWS 22-1.5</p>  <p>CROSS SECTION</p>	<p>AON W01-358-7444</p> <p>3215 3212 or 3183</p>  <p>BEAD PLATE TOP BEAD PLATE BOTTOM</p>	<p>12.71</p> <p>APPLICATIONS: Hendrickson Trailer S9830</p>
<p>BELLOWS 22-1.5</p>  <p>CROSS SECTION</p>	<p>AON W01-358-7446</p> <p>3271 3183</p>  <p>BEAD PLATE TOP BEAD PLATE BOTTOM</p>	<p>14.43</p> <p>APPLICATIONS: Hendrickson Trailer S3798 R & S Truck & Body 1082914 Watson & Chalin AS-0005</p>
<p>BELLOWS 22-1.5</p>  <p>CROSS SECTION</p>	<p>AON W01-358-7447</p> <p>3210 3183</p>  <p>BEAD PLATE TOP BEAD PLATE BOTTOM</p>	<p>14.14</p> <p>APPLICATIONS: EZ Ride 8030150 Hendrickson Trailer S6242 Silent Drive</p>
<p>BELLOWS 22-1.5</p>  <p>CROSS SECTION</p>	<p>AON W01-358-7473</p> <p>3215 3183</p>  <p>BEAD PLATE TOP BEAD PLATE BOTTOM</p>	<p>14.42</p> <p>APPLICATIONS: Ridewell 1003587473C</p>

HARDWARE KEY

- Bolt or Stud 1/2-13
- ⊗ Air Inlet 1/4 N.P.T.
- ⊗ Combination Stud/Air Inlet Stud Outside Thread is 3/4-16 Pistons
- ⊗ Exception to Standard Stud/Air Inlet Stud Inside Thread of 1/4 N.P.T.

- ▲ No Alignment Specified-Center Stud Mounting is Standard
- ⊗ Threaded Hole 3/8-16 Blind Nut on Bead Plates 1/2-13 Pistons

<p>BELLOWS 22-1.5</p>	<p>AON W01-358-7790</p>	<p>14.33</p>	
<p>CROSS SECTION</p>	<p>3003</p> <p>BEAD PLATE TOP</p>	<p>3183</p> <p>BEAD PLATE BOTTOM</p>	<p>APPLICATIONS: Hendrickson Aux. 001475</p>
<p>BELLOWS 26</p>	<p>AON W01-358-7325</p>	<p>5.31</p>	
<p>CROSS SECTION</p>	<p>3450</p> <p>BEAD PLATE TOP</p>	<p>3436</p> <p>BEAD PLATE BOTTOM</p>	<p>APPLICATIONS: American Carrier 8003-006 Mack 227QS-32 & 57QK1113 Sauer P10-754 Texas Truck Watson & Chalin AS-0030</p>
<p>BELLOWS 26</p>	<p>AON W01-358-7330</p>	<p>5.37</p>	
<p>CROSS SECTION</p>	<p>3371</p> <p>BEAD PLATE TOP</p>	<p>3363</p> <p>BEAD PLATE BOTTOM</p>	<p>APPLICATIONS: Ridewell 1003587330</p>
<p>BELLOWS 26</p>	<p>AON W01-358-7339</p>	<p>4.77</p>	
<p>CROSS SECTION</p>	<p>3071</p> <p>BEAD PLATE TOP</p>	<p>3363</p> <p>BEAD PLATE BOTTOM</p>	<p>APPLICATIONS:</p>
<p>BELLOWS 26</p>	<p>AON W01-358-7504</p>	<p>5.33</p>	
<p>CROSS SECTION</p>	<p>3067</p> <p>BEAD PLATE TOP</p>	<p>3436</p> <p>BEAD PLATE BOTTOM</p>	<p>APPLICATIONS:</p>

AUXILIARY / TAG AXLE

<p>BELLOWS 26</p> <p>CROSS SECTION</p> <p>BEAD PLATE TOP</p> <p>BEAD PLATE BOTTOM</p>	<p>AON W01-358-7505</p> <p>5.54</p> <p>APPLICATIONS: Hendrickson 001347</p>
<p>BELLOWS 26</p> <p>CROSS SECTION</p> <p>BEAD PLATE TOP</p> <p>BEAD PLATE BOTTOM</p>	<p>AON W01-358-7659</p> <p>5.03</p> <p>APPLICATIONS: Hendrickson 005079</p>
<p>BELLOWS 26</p> <p>CROSS SECTION</p> <p>BEAD PLATE TOP</p> <p>BEAD PLATE BOTTOM</p>	<p>AON W01-358-7705</p> <p>4.87</p> <p>APPLICATIONS: Watson Chalin AS-006 (Replaces 7503)</p>
<p>BELLOWS 28</p> <p>CROSS SECTION</p> <p>BEAD PLATE TOP</p> <p>BEAD PLATE BOTTOM</p>	<p>AON W01-358-7271</p> <p>31.67</p> <p>APPLICATIONS: Ridewell 1003587271C</p>
<p>BELLOWS 28</p> <p>CROSS SECTION</p> <p>BEAD PLATE TOP</p> <p>BEAD PLATE BOTTOM</p>	<p>AON W01-358-7512</p> <p>36.33</p> <p>APPLICATIONS: Wilmar Gallenberg</p>

HARDWARE KEY

- Bolt or Stud 1/2-13
- ⊗ Air Inlet 1/4 N.P.T.
- ⊙ Combination Stud/Air Inlet Stud Outside Thread is 3/4-16 Pistons
- ⊕ Exception to Standard Stud/Air Inlet Stud Inside Thread of 1/4 N.P.T.

- ▲ No Alignment Specified-Center Stud Mounting is Standard
- ⊕ Threaded Hole 3/8-16 Blind Nut on Bead Plates 1/2-13 Pistons

<p>BELLOWS 29</p>	<p>AON W01-358-7275</p>	<p>53.18</p>
<p>CROSS SECTION</p>	<p>BEAD PLATE TOP BEAD PLATE BOTTOM</p>	<p>APPLICATIONS: Ridewell 1003587275C</p>
<p>BELLOWS 201</p>	<p>AON W01-358-7244</p>	<p>19.87</p>
<p>(Includes bolts, nuts, & washers)</p> <p>CROSS SECTION</p>	<p>BEAD PLATE TOP BEAD PLATE BOTTOM</p>	<p>APPLICATIONS: Ridewell 1003587271C</p>
<p>BELLOWS 203</p>	<p>AON W01-358-7273</p>	<p>43.21</p>
<p>CROSS SECTION</p>	<p>BEAD PLATE TOP BEAD PLATE BOTTOM</p>	<p>APPLICATIONS: Ridewell 1003587273C Watson & Chalin AS-0045</p>
<p>BELLOWS 205</p>	<p>AON W01-358-7927</p>	<p>22.25</p>
<p>CROSS SECTION</p>	<p>BEAD PLATE TOP BEAD PLATE BOTTOM</p>	<p>APPLICATIONS: Maurice Welding</p>
<p>BELLOWS 215</p>	<p>AON W01-358-7230</p>	<p>41.02</p>
<p>(Includes bolts, nuts, & washers)</p> <p>CROSS SECTION</p>	<p>BEAD PLATE TOP BEAD PLATE BOTTOM</p>	<p>BEAD RING WC1-358-3499</p> <p>APPLICATIONS: Pollard Holland Hitch 6788</p>

<p>BELLOWS 224</p>	<p>AON W01-358-3400</p>	<p>4.92</p>
<p>CROSS SECTION</p>	<p>3450</p> <p>BEAD PLATE TOP</p> <p>3436</p> <p>BEAD PLATE BOTTOM</p>	<p>APPLICATIONS: American Carrier 8003-009</p>
<p>BELLOWS 224</p>	<p>AON W01-358-3402</p>	<p>5.01</p>
<p>CROSS SECTION</p>	<p>3355</p> <p>BEAD PLATE TOP</p> <p>3453</p> <p>BEAD PLATE BOTTOM</p>	<p>APPLICATIONS: American Carrier 8003-026 (supersedes 9455-Bellows 1T47A-1)</p> <p>REPLACES W01-358-3401 AND W01-358-3405</p>
<p>BELLOWS 224</p>	<p>AON W01-358-3406</p>	<p>4.96</p>
<p>CROSS SECTION</p>	<p>3371</p> <p>BEAD PLATE TOP</p> <p>3436</p> <p>BEAD PLATE BOTTOM</p>	<p>APPLICATIONS: Sauer P20-706</p> <p>OBSELETE: NO LONGER AVAILABLE</p>
<p>BELLOWS 228-1.5</p>	<p>AON W01-358-7472</p>	<p>14.10</p>
<p>CROSS SECTION</p>	<p>3210</p> <p>BEAD PLATE TOP</p> <p>3212 or 3183</p> <p>BEAD PLATE BOTTOM</p>	<p>APPLICATIONS: Hendrickson Can. B-12514-005</p>
<p>BELLOWS 228-1.5</p>	<p>AON W01-358-7545</p>	<p>14.86</p>
<p>CROSS SECTION</p>	<p>3271</p> <p>BEAD PLATE TOP</p> <p>3183</p> <p>BEAD PLATE BOTTOM</p>	<p>APPLICATIONS: Hendrickson Aux. 001796 (Paralift Ultra/ High Lift) -lift bag Watson & Chalin AS-0087-1F</p>

HARDWARE KEY

- Bolt or Stud 1/2-13
- ⊗ Air Inlet 1/4 N.P.T.
- ⊗ Combination Stud/Air Inlet Stud Outside Thread is 3/4-16 Pistons
- ⊗ Exception to Standard Stud/Air Inlet Stud Inside Thread of 1/4 N.P.T.

- ▲ No Alignment Specified-Center Stud Mounting is Standard
- ⊗ Threaded Hole 3/8-16 Blind Nut on Bead Plates 1/2-13 Pistons

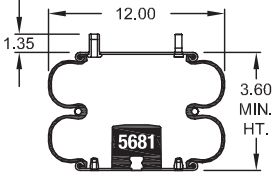
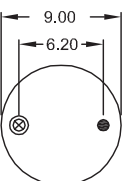
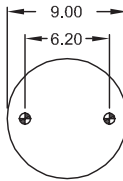
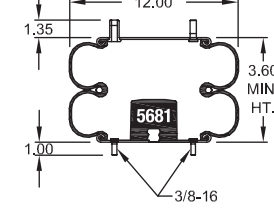
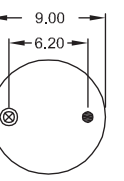
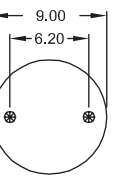
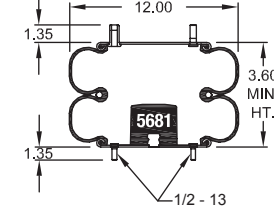
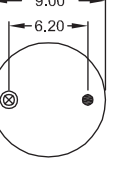
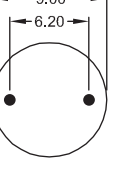
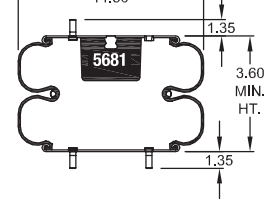
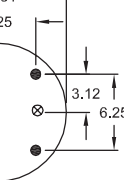
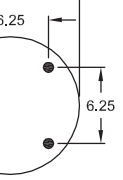
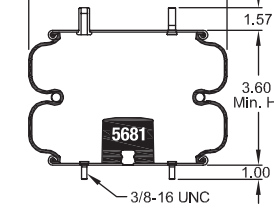
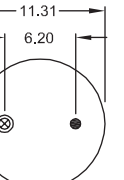
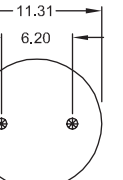
<p>BELLOWS 228-1.5</p>	<p>AON W01-358-7550</p>	<p>14.32</p>
 <p>CROSS SECTION</p>	<p>3271</p>  <p>BEAD PLATE TOP</p>	<p>3183</p>  <p>BEAD PLATE BOTTOM</p> <p>APPLICATIONS: Watson & Chalin AS-0087 Histeer 10315</p>
<p>BELLOWS 228-1.5</p>	<p>AON W01-358-7555</p>	<p>14.49</p>
 <p>CROSS SECTION</p>	<p>3271</p>  <p>BEAD PLATE TOP</p>	<p>3194</p>  <p>BEAD PLATE BOTTOM</p> <p>APPLICATIONS: Reyco 20018-01 (86AR) Binkley XB-SPN-053-37</p>
<p>BELLOWS 228-1.5</p>	<p>AON W01-358-7949</p>	<p>14.84</p>
 <p>CROSS SECTION</p>	<p>3271</p>  <p>BEAD PLATE TOP</p>	<p>3194</p>  <p>BEAD PLATE BOTTOM</p> <p>APPLICATIONS:</p>
<p>BELLOWS 233-2</p>	<p>AON W01-358-6799</p>	<p>21.78</p>
 <p>CROSS SECTION</p>	<p>3132</p>  <p>BEAD PLATE TOP</p>	<p>3122</p>  <p>BEAD PLATE BOTTOM</p> <p>APPLICATIONS: Holland (Neway) 90557203</p>
<p>BELLOWS 233-2</p>	<p>AON W01-358-7557</p>	<p>20.57</p>
 <p>CROSS SECTION</p>	<p>3187</p>  <p>BEAD PLATE TOP</p>	<p>3108</p>  <p>BEAD PLATE BOTTOM</p> <p>APPLICATIONS: Reyco 19983-01 (21AR, 74AR) Watson & Chalin AS-0089 Histeer 10316</p>

AUXILIARY / TAG AXLE

<p>BELLOWS 233-2</p> <p>CROSS SECTION</p> <p>BEAD PLATE TOP</p> <p>BEAD PLATE BOTTOM</p>	<p>AON W01-358-7781</p> <p>APPLICATIONS: Ridewell 1003587781C</p>	<p>23.11</p>
<p>BELLOWS 233-2</p> <p>CROSS SECTION</p> <p>BEAD PLATE TOP</p> <p>BEAD PLATE BOTTOM</p>	<p>AON W01-358-7782</p> <p>APPLICATIONS: Porcupine (replaces 7140) Watson & Chalin AS-0032 (replaces 7240)</p>	<p>22.06</p>
<p>BELLOWS 264</p> <p>CROSS SECTION</p> <p>BEAD PLATE TOP</p> <p>BEAD PLATE BOTTOM</p>	<p>AON W01-358-3420</p> <p>APPLICATIONS: Hendrickson Aux. 004647</p>	<p>5.34</p>
<p>BELLOWS 267-1.5</p> <p>CROSS SECTION</p> <p>BEAD PLATE TOP</p> <p>BEAD PLATE BOTTOM</p>	<p>AON W01-358-6215</p> <p>APPLICATIONS:</p>	<p>3.35</p>
<p>BELLOWS 267-1.5</p> <p>CROSS SECTION</p> <p>BEAD PLATE TOP</p> <p>BEAD PLATE BOTTOM</p>	<p>AON W01-358-6831</p> <p>APPLICATIONS: John Deere AW30683</p>	<p>TANK VALVE WC1-358-0009</p> <p>3.34</p>

- HARDWARE KEY**
- Bolt or Stud 1/2-13
 - ⊗ Air Inlet 1/4 N.P.T.
 - ⊙ Combination Stud/Air Inlet Stud Outside Thread is 3/4-16 Pistons
 - ⊕ Exception to Standard Stud/Air Inlet Stud Inside Thread of 1/4 N.P.T.

- ▲ No Alignment Specified-Center Stud Mounting is Standard
- ⊕ Threaded Hole 3/8-16 Blind Nut on Bead Plates 1/2-13 Pistons

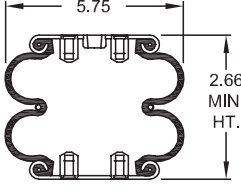
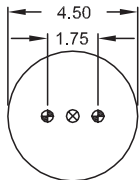
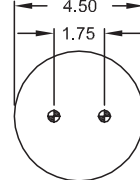
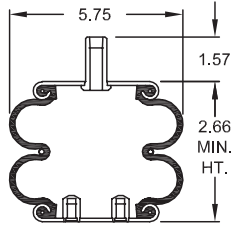
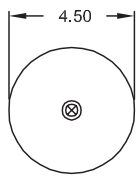
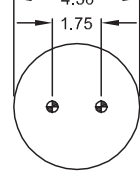
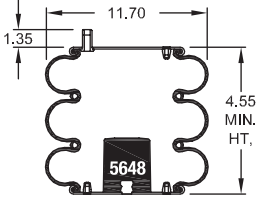
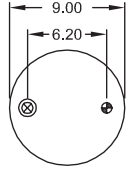
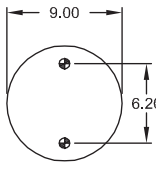
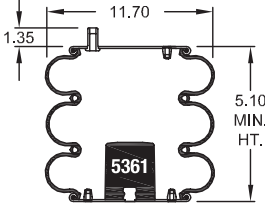
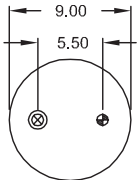
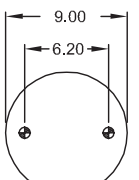
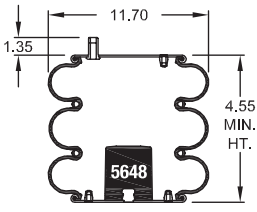
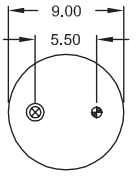
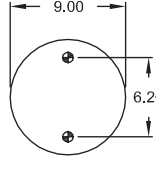
<p>BELLOWS 268</p>	<p>AON W01-358-7025</p>	<p>3.23</p>
 <p>CROSS SECTION</p>	<p>3030</p>  <p>BEAD PLATE TOP</p> <p>3025</p>  <p>BEAD PLATE BOTTOM</p>	<p>APPLICATIONS: WESTERN STAR (Cab Spring)</p>
<p>BELLOWS 268</p>	<p>AON W01-358-7057</p>	<p>3.37</p>
 <p>CROSS SECTION</p>	<p>3065</p>  <p>BEAD PLATE TOP</p> <p>3025</p>  <p>BEAD PLATE BOTTOM</p>	<p>APPLICATIONS: Sauer P10-794</p> <p>OBSOLETE: NO LONGER AVAILABLE</p>
<p>BELLOWS 38</p>	<p>AON W01-358-7990</p>	<p>16.03</p>
 <p>CROSS SECTION</p>	<p>3351</p>  <p>BEAD PLATE TOP</p> <p>3183</p>  <p>BEAD PLATE BOTTOM</p>	<p>APPLICATIONS: Watson & Chalin AS-0048</p>
<p>BELLOWS 38</p>	<p>AON W01-358-7994</p>	<p>16.44</p>
 <p>CROSS SECTION</p>	<p>3210</p>  <p>BEAD PLATE TOP</p> <p>3183</p>  <p>BEAD PLATE BOTTOM</p>	<p>APPLICATIONS: Watson & Chalin AS-0019-1F (ref. W01-358-8008)</p>
<p>BELLOWS 38</p>	<p>AON W01-358-7995</p>	<p>17.49</p>
 <p>CROSS SECTION</p>	<p>3210</p>  <p>BEAD PLATE TOP</p> <p>3183</p>  <p>BEAD PLATE BOTTOM</p>	<p>APPLICATIONS: Watson & Chalin AS-0048-1F (ref. W01-358-8032)</p>







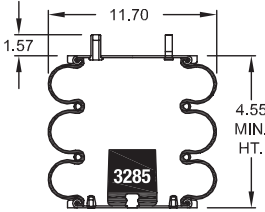
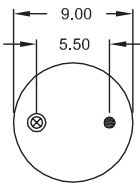
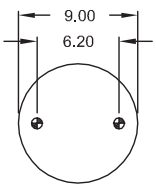

AUXILIARY / TAG AXLE

<p>BELLOWS 38</p>	<p>AON W01-358-7996</p>	<p>15.92</p>
<p>CROSS SECTION</p>	<p>3271</p> <p>BEAD PLATE TOP</p> <p>3183</p> <p>BEAD PLATE BOTTOM</p>	<p>APPLICATIONS: Granning 8221</p>
<p>BELLOWS 38</p>	<p>AON W01-358-8006</p>	<p>14.46</p>
<p>CROSS SECTION</p>	<p>3208</p> <p>BEAD PLATE TOP</p> <p>3212 or 3183</p> <p>BEAD PLATE BOTTOM</p>	<p>APPLICATIONS: Superior</p>
<p>BELLOWS 38</p>	<p>AON W01-358-8008</p>	<p>17.67</p>
<p>CROSS SECTION</p>	<p>3210</p> <p>BEAD PLATE TOP</p> <p>3183</p> <p>BEAD PLATE BOTTOM</p>	<p>APPLICATIONS: EZ Ride Histeer Ridewell 1003588008C Silent Drive Watson & Chalin AS-0019 Hendrickson Trailer S11637</p>
<p>BELLOWS 38</p>	<p>AON W01-358-8010</p>	<p>17.71</p>
<p>CROSS SECTION</p>	<p>3215</p> <p>BEAD PLATE TOP</p> <p>3183</p> <p>BEAD PLATE BOTTOM</p>	<p>APPLICATIONS: Ridewell 1003588010C Tafco Oshkosh (ref.8013)</p>
<p>BELLOWS 38</p>	<p>AON W01-358-8014</p>	<p>16.62</p>
<p>CROSS SECTION</p>	<p>3241</p> <p>BEAD PLATE TOP</p> <p>3183</p> <p>BEAD PLATE BOTTOM</p>	<p>APPLICATIONS: Ridewell 1003588014C</p> <p>OBSELETE: NO LONGER AVAILABLE</p>

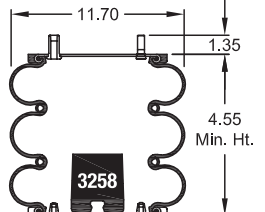
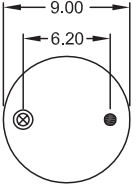
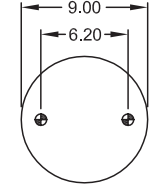
HARDWARE KEY

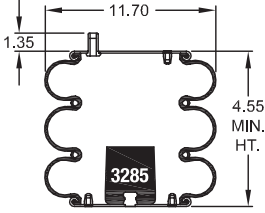
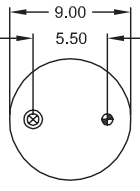
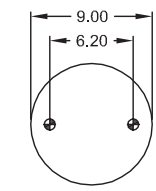
- Bolt or Stud 1/2-13
- ⊗ Air Inlet 1/4 N.P.T.
- ⊗ Combination Stud/Air Inlet Stud Outside Thread is 3/4-16 Pistons
- ⊗ Exception to Standard Stud/Air Inlet Stud Inside Thread of 1/4 N.P.T.

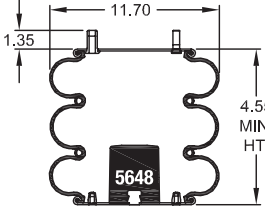
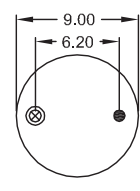
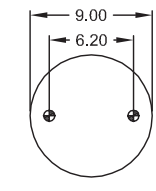
- ▲ No Alignment Specified-Center Stud Mounting is Standard
- ⊗ Threaded Hole 3/8-16 Blind Nut on Bead Plates 1/2-13 Pistons

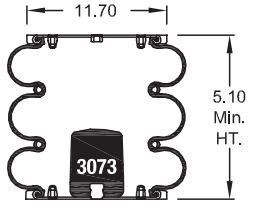
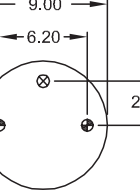
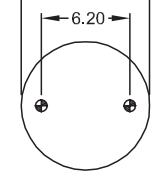
BELLOWS 38	AON W01-358-8016	 13.98
 <p>CROSS SECTION</p>	<div style="display: flex; justify-content: space-around;"> <div data-bbox="560 220 673 451"> <p>3235</p>  <p>BEAD PLATE TOP</p> </div> <div data-bbox="771 220 917 451"> <p>3183</p>  <p>BEAD PLATE BOTTOM</p> </div> </div>	<p>APPLICATIONS: Ridewell 1003588016C</p>
BELLOWS 38	AON W01-358-8018	 17.28
 <p>CROSS SECTION</p>	<div style="display: flex; justify-content: space-around;"> <div data-bbox="560 583 673 814"> <p>3271</p>  <p>BEAD PLATE TOP</p> </div> <div data-bbox="771 583 917 814"> <p>3183</p>  <p>BEAD PLATE BOTTOM</p> </div> </div>	<p>APPLICATIONS: Histeer Reyco 93AR Suspensions Inc. Watson & Chalin</p>
BELLOWS 38	AON W01-358-8025	 17.34
 <p>CROSS SECTION</p>	<div style="display: flex; justify-content: space-around;"> <div data-bbox="560 947 673 1178"> <p>3210</p>  <p>BEAD PLATE TOP</p> </div> <div data-bbox="771 947 917 1178"> <p>3183</p>  <p>BEAD PLATE BOTTOM</p> </div> </div>	<p>APPLICATIONS: Silent Drive Van Raden</p> <p>REPLACES W01-358-8028</p>
BELLOWS 38	AON W01-358-8027	 16.50
 <p>CROSS SECTION</p>	<div style="display: flex; justify-content: space-around;"> <div data-bbox="560 1310 673 1541"> <p>3271</p>  <p>BEAD PLATE TOP</p> </div> <div data-bbox="771 1310 917 1541"> <p>3183</p>  <p>BEAD PLATE BOTTOM</p> </div> </div>	<p>APPLICATIONS: Suspensions Inc. 200117 Histeer (supersedes 8029) Silent Drive</p>
BELLOWS 38	AON W01-358-8030	 18.33
 <p>CROSS SECTION</p>	<div style="display: flex; justify-content: space-around;"> <div data-bbox="560 1673 673 1904"> <p>3215</p>  <p>BEAD PLATE TOP</p> </div> <div data-bbox="771 1673 917 1904"> <p>3183</p>  <p>BEAD PLATE BOTTOM</p> </div> </div>	<p>APPLICATIONS: Ridewell 1003588030C</p>

<p>BELLOWS 38</p> <p>CROSS SECTION</p> <p>BEAD PLATE TOP</p> <p>BEAD PLATE BOTTOM</p>	<p>AON W01-358-8032</p> <p>3210</p> <p>3183</p> <p>APPLICATIONS: Hendrickson Trailer S12405</p>	<p>18.09</p>
<p>BELLOWS 38</p> <p>CROSS SECTION</p> <p>BEAD PLATE TOP</p> <p>BEAD PLATE BOTTOM</p>	<p>AON W01-358-8033</p> <p>3271</p> <p>3292</p> <p>APPLICATIONS: Hendrickson Trailer S14487 (Ride Bag) [Paralift Ultra] [Pararev] Hendrickson Aux. 003316 (metric version)</p>	<p>16.78</p>
<p>BELLOWS 39</p> <p>CROSS SECTION</p> <p>BEAD PLATE TOP</p> <p>BEAD PLATE BOTTOM</p>	<p>AON W01-358-7852</p> <p>3132</p> <p>3122</p> <p>APPLICATIONS: Porcupine Maurice Welding</p>	<p>28.58</p>
<p>BELLOWS 312</p> <p>CROSS SECTION</p> <p>BEAD PLATE TOP</p> <p>BEAD PLATE BOTTOM</p>	<p>AON W01-358-7286</p> <p>3741</p> <p>3472</p> <p>APPLICATIONS: Ridewell 1003587286C Superior</p>	<p>38.18</p>
<p>BELLOWS 312</p> <p>CROSS SECTION</p> <p>BEAD PLATE TOP</p> <p>BEAD PLATE BOTTOM</p> <p>(includes-1.87 lb. bolts, nuts, & washers)</p>	<p>AON W01-358-7761</p> <p>4299</p> <p>4299</p> <p>APPLICATIONS: Superior</p>	<p>24.60</p>

HARDWARE KEY

- Bolt or Stud 1/2-13
- ⊗ Air Inlet 1/4 N.P.T.
- ⊗ Combination Stud/Air Inlet Stud Outside Thread is 3/4-16 Pistons
- ⊗ Exception to Standard Stud/Air Inlet Stud Inside Thread of 1/4 N.P.T.

- ▲ No Alignment Specified-Center Stud Mounting is Standard
- ⊗ Threaded Hole 3/8-16 Blind Nut on Bead Plates 1/2-13 Pistons

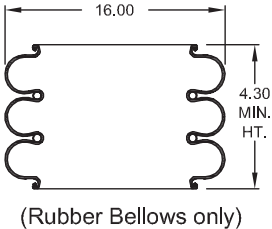
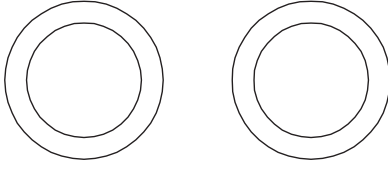
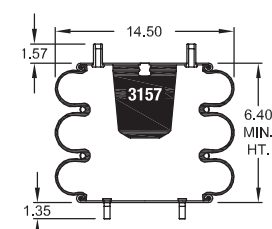
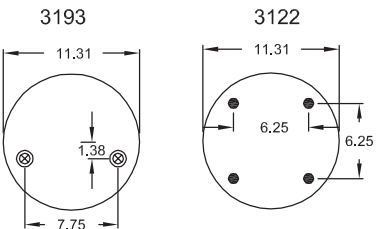
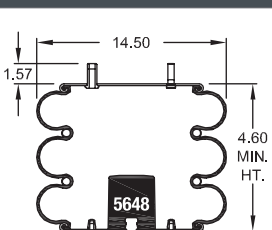
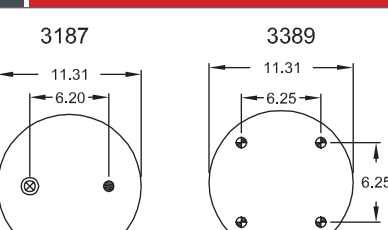
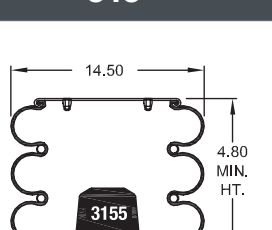
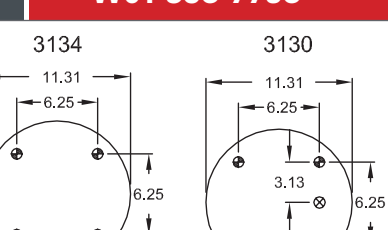
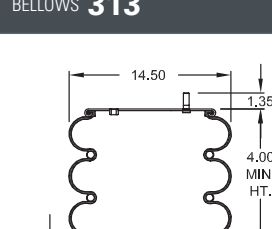
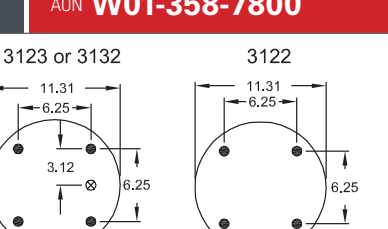
<p>BELLOWS 312</p>	<p>AON W01-358-7915</p>	<p>15.77</p>
 <p>(Rubber Bellows only)</p> <p>CROSS SECTION</p>	 <p>BEAD PLATE TOP</p> <p>BEAD PLATE BOTTOM</p>	<p>APPLICATIONS: Superior</p>
<p>BELLOWS 313</p>	<p>AON W01-358-7796</p>	<p>25.24</p>
 <p>CROSS SECTION</p>	 <p>BEAD PLATE TOP</p> <p>BEAD PLATE BOTTOM</p>	<p>APPLICATIONS: Ridewell 1003587796C</p> <p>OBSOLETE: NO LONGER AVAILABLE</p>
<p>BELLOWS 313</p>	<p>AON W01-358-7797</p>	<p>21.01</p>
 <p>CROSS SECTION</p>	 <p>BEAD PLATE TOP</p> <p>BEAD PLATE BOTTOM</p>	<p>APPLICATIONS: Hendrickson Aux. 001346</p>
<p>BELLOWS 313</p>	<p>AON W01-358-7798</p>	<p>23.90</p>
 <p>CROSS SECTION</p>	 <p>BEAD PLATE TOP</p> <p>BEAD PLATE BOTTOM</p>	<p>APPLICATIONS: Allison Granning 1613 R & S Truck & Body Watson & Chalin AS-0006</p>
<p>BELLOWS 313</p>	<p>AON W01-358-7800</p>	<p>23.97</p>
 <p>CROSS SECTION</p>	 <p>BEAD PLATE TOP</p> <p>BEAD PLATE BOTTOM</p>	<p>APPLICATIONS: Granning 4514 Holland Hitch 4514 Ridewell 1003587800C Silent Drive</p>

AUXILIARY / TAG AXLE

BELLOWS 313	AON W01-358-7808	20.64
 CROSS SECTION	3131 or 3134 BEAD PLATE TOP	3130 BEAD PLATE BOTTOM
APPLICATIONS: Ridewell 1003587808C Truckstell (Marion Mfg.) 63640 EZ Ride 8030170		

BELLOWS 313	AON W01-358-7818	23.70
 CROSS SECTION	3132 BEAD PLATE TOP	3122 BEAD PLATE BOTTOM
APPLICATIONS: EZ Ride 8030180 Granning 1014 Ridewell 1003587818C Superior Watson & Chalin AS-0025		







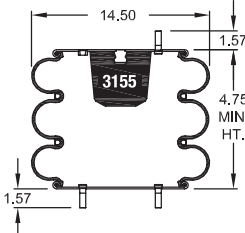
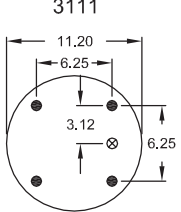
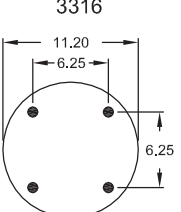

BELLOWS 320	AON W01-358-7276	64.94
 CROSS SECTION	3473 BEAD PLATE TOP	3474 BEAD PLATE BOTTOM
APPLICATIONS: Wabash		

BELLOWS 321	AON W01-358-7304	54.50
 CROSS SECTION (Includes bolts, nuts, & washers)	4311 BEAD PLATE TOP	4311 BEAD PLATE BOTTOM
APPLICATIONS: Ottawa 53500516 Pollard Holland Hitch 6764 REPLACES W01-358-7320		

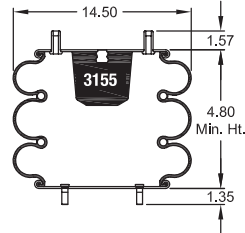
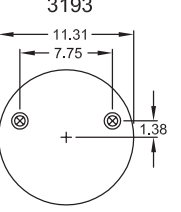
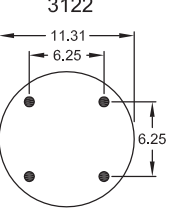
BELLOWS 323	AON W01-358-7274	54.22
 CROSS SECTION	3475 BEAD PLATE TOP	3476 BEAD PLATE BOTTOM
APPLICATIONS: Ridewell 1003587274C		

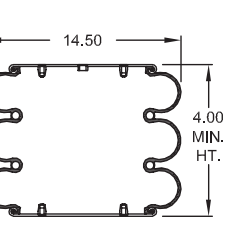
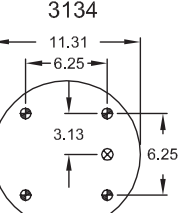
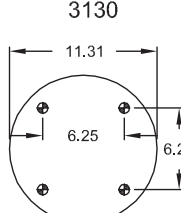
- HARDWARE KEY**
- Bolt or Stud 1/2-13
 - ⊗ Air Inlet 1/4 N.P.T.
 - ⊙ Combination Stud/Air Inlet Stud Outside Thread is 3/4-16 Pistons
 - ⊕ Exception to Standard Stud/Air Inlet Stud Inside Thread of 1/4 N.P.T.

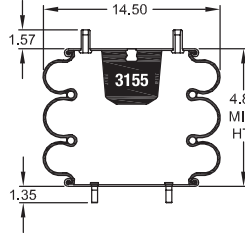
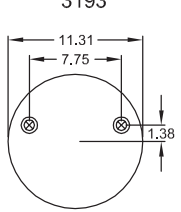
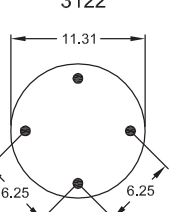
- ▲ No Alignment Specified-Center Stud Mounting is Standard
- ⊕ Threaded Hole 3/8-16 Blind Nut on Bead Plates 1/2-13 Pistons

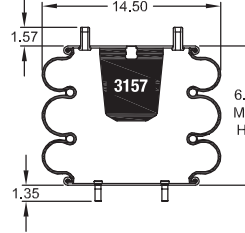
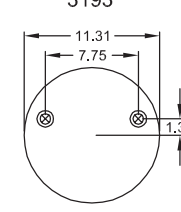
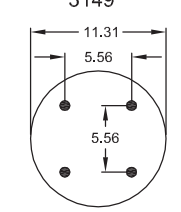





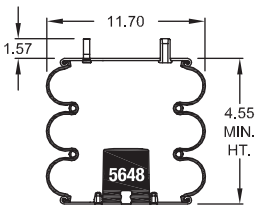
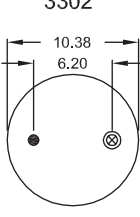
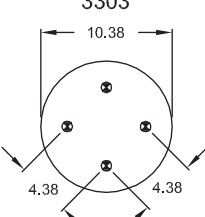

BELLOWS 333	AON W01-358-7839	 28.49
 <p>CROSS SECTION</p>	 <p>3111 BEAD PLATE TOP</p>  <p>3316 BEAD PLATE BOTTOM</p>	<p>APPLICATIONS: Hendrickson Trailer S6861 Histeer 10300 Porcupine (replaces 7818) Ridewell Watson & Chalin AS-0033 Silent Drive Superior</p>
BELLOWS 333	AON W01-358-7843	 28.78
 <p>CROSS SECTION</p>	 <p>3193 BEAD PLATE TOP</p>  <p>3122 BEAD PLATE BOTTOM</p>	<p>APPLICATIONS: Hendrickson Trailer S7100</p>
BELLOWS 333	AON W01-358-7845	 24.38
 <p>CROSS SECTION</p>	 <p>3134 BEAD PLATE TOP</p>  <p>3130 BEAD PLATE BOTTOM</p>	<p>APPLICATIONS: EZ Ride</p>
BELLOWS 333	AON W01-358-7846	 28.40
 <p>CROSS SECTION</p>	 <p>3193 BEAD PLATE TOP</p>  <p>3122 BEAD PLATE BOTTOM</p>	<p>APPLICATIONS: Hendrickson Trailer S7853</p>
BELLOWS 333	AON W01-358-7847	 29.64
 <p>CROSS SECTION</p>	 <p>3193 BEAD PLATE TOP</p>  <p>3149 BEAD PLATE BOTTOM</p>	<p>APPLICATIONS: Hendrickson Trailer S8874</p>

<p>BELLOWS 333</p> <p>CROSS SECTION</p> <p>BEAD PLATE TOP</p> <p>BEAD PLATE BOTTOM</p>	<p>AON W01-358-7848</p> <p>24.68</p> <p>APPLICATIONS: Superior Suspensions Inc.</p>
<p>BELLOWS 333</p> <p>CROSS SECTION</p> <p>BEAD PLATE TOP</p> <p>BEAD PLATE BOTTOM</p>	<p>AON W01-358-7850</p> <p>28.03</p> <p>APPLICATIONS: Histeer 10301 Suspensions Inc. 200177 Watson & Chalin AS-0086 (Replaces 7851 - adapter plates might be required)</p> <p>REPLACES W01-358-7837</p>
<p>BELLOWS 333</p> <p>CROSS SECTION</p> <p>BEAD PLATE TOP</p> <p>BEAD PLATE BOTTOM</p>	<p>AON W01-358-7862</p> <p>25.24</p> <p>APPLICATIONS: Hendrickson Aux. 001795 (Paralift Ultra/ High Lift) -ride bag</p>
<p>BELLOWS 333</p> <p>CROSS SECTION</p> <p>BEAD PLATE TOP</p> <p>BEAD PLATE BOTTOM</p>	<p>AON W01-358-7872</p> <p>25.17</p> <p>APPLICATIONS: Hendrickson Aux. 004828</p>
<p>BELLOWS 352</p> <p>CROSS SECTION</p> <p>BEAD PLATE TOP</p> <p>BEAD PLATE BOTTOM</p>	<p>AON W01-358-7954</p> <p>20.26</p> <p>APPLICATIONS: Hendrickson Aux. 002348</p> <p>OBSOLETE: NO LONGER AVAILABLE</p>

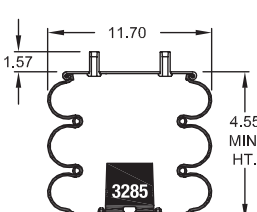
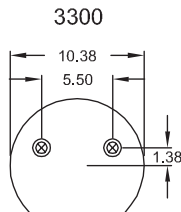
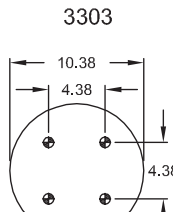
HARDWARE KEY

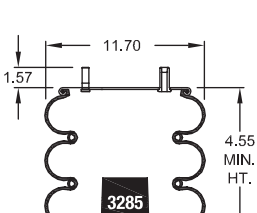
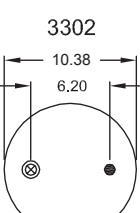
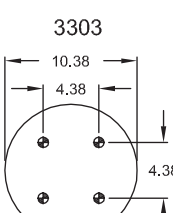
- Bolt or Stud 1/2-13
- ⊗ Air Inlet 1/4 N.P.T.
- ⊗ Combination Stud/Air Inlet Stud Outside Thread is 3/4-16 Pistons
- ⊗ Exception to Standard Stud/Air Inlet Stud Inside Thread of 1/4 N.P.T.

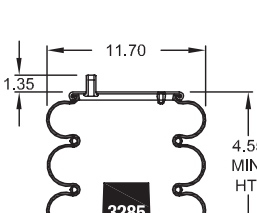
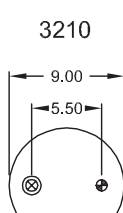
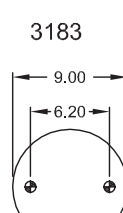
- ▲ No Alignment Specified-Center Stud Mounting is Standard
- ⊗ Threaded Hole 3/8-16 Blind Nut on Bead Plates 1/2-13 Pistons

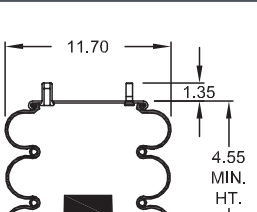
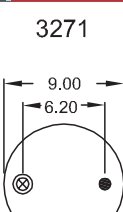
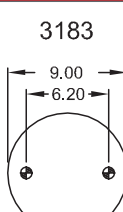
BELLOWS 352	AON W01-358-7956	 19.13
 <p>CROSS SECTION</p>	 <p>3302</p>  <p>3303</p> <p>BEAD PLATE TOP</p> <p>BEAD PLATE BOTTOM</p>	<p>APPLICATIONS: Rowe Truck 0059 ASC 1500</p>
BELLOWS 352	AON W01-358-8042	 19.85
 <p>CROSS SECTION</p>	 <p>3300</p>  <p>3303</p> <p>BEAD PLATE TOP</p> <p>BEAD PLATE BOTTOM</p>	<p>APPLICATIONS: Hendrickson Aux. 001015 Holland (Neway) 90557236 V-Steer II (Ride Bag)</p>
BELLOWS 352	AON W01-358-8043	 20.11
 <p>CROSS SECTION</p>	 <p>3302</p>  <p>3303</p> <p>BEAD PLATE TOP</p> <p>BEAD PLATE BOTTOM</p>	<p>APPLICATIONS: Hendrickson Trailer S14795</p>
BELLOWS 354	AON W01-358-8038	 18.10
 <p>CROSS SECTION</p>	 <p>3210</p>  <p>3183</p> <p>BEAD PLATE TOP</p> <p>BEAD PLATE BOTTOM</p>	<p>APPLICATIONS: Silent Drive Longer Stroke 8008 Hyster 10313</p>
BELLOWS 354	AON W01-358-8039	 16.71
 <p>CROSS SECTION</p>	 <p>3271</p>  <p>3183</p> <p>BEAD PLATE TOP</p> <p>BEAD PLATE BOTTOM</p>	<p>APPLICATIONS: Hyster 10303 (Longer Stroke 8018)</p>



Sleeve style air springs are used for cab and seating applications, creating a smooth, comfortable ride.

READING THE PARTS TABLE

1 LOGO ORANGE	2 AON W02-358-7058	7 1.30	8 Composite
	4 CAP ID NO. NBD-10409 (7042)	9 APPLICATIONS: NATIONAL SEATING 324662-01 (W02-N19-7058)	
5 PISTON ID NO. NBD-12708 (6896)		10 OBSOLETE	
6 BCR \updownarrow 9.00			

1. Logo Color

The Airide spring shield color indicates a very specific construction of the bellows, which helps with the identification process of the air spring.

2. Assembly Order Number (AON)

This number identifies the specific Firestone assembly order number that needs to be used for ordering purposes. It is important that the complete order number is used to avoid any confusion, especially with any type of electronic ordering. The complete order number in this example is W02-358-7058.

3. Cross Section View

Includes dimensional information in inches for **uninflated** diameter, maximum height, and collapsed height, as well as component dimensions.

4. Cap Identification Number

The drawing number is molded into most caps, followed by a 4 digit number in parentheses identifying the internal cap component number. Do not confuse this code with the AON.

5. Piston Identification Number

The piston identification number is molded into most pistons, followed by a 4 digit number in parentheses identifying the internal piston component number. Do not confuse this code with the AON.

6. BCR

This dimension is the measurement taken between the two metal rings on each end of the assembly. Note: BCR measurement will be somewhat shorter than specified in this guide.

7. Weight

The total weight of the spring assembly.

8. Piston Material

Aluminum, Steel, or Composite.

9. Applications

Includes all the information that is known about this specific application (i.e., model number, years of manufacture, part numbers, Firestone reference numbers, and competitor numbers, if known).

10. Assembly Notes

Important information if an assembly has been obsoleted and if there is an exact replacement part available, or if it has replaced other parts.

AIR SPRING IDENTIFICATION

Assembly Order Number (AON) 2

The quickest way to identify the air spring is to read the manufacturer or Firestone assembly order number (AON) on the label adhered to the cap. The complete order number must include the W02 number at the beginning. Use the following pages to find the correct number for your air spring. The complete AON in the diagram is W02-358-7058.

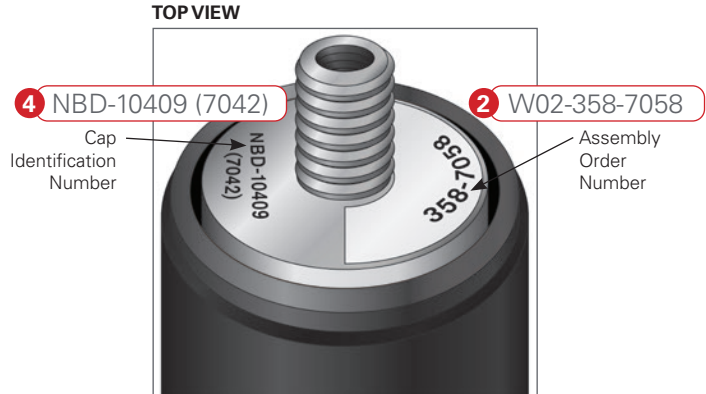

Logo Color 1

The parts tables are sorted by the air spring logo color. If the AON number is not legible, identify the Airide spring shield color to narrow down your search. From there, follow the steps below to identify your air spring.

Cap Identification Number 4

The cap can be used for further part identification in the parts diagrams by matching the drawing number (e.g. NBD-10409) or the cap component number (7042). In addition, the crimp (metal) ring around the cap has a code stamped into it. The last 4 digits of the seven-number string at the beginning of the code reference the cap identification number.



Piston Identification Number 5



The piston drawing (NBD-12708) or internal piston component number (6896) molded into the piston can also be used to narrow down the search for the correct replacement part.

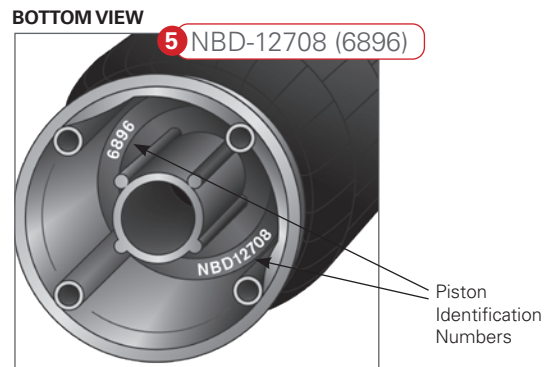

BCR 6



If an additional identifier is needed, measure the distance between the two metal rings – one holding the cap in place and the other holding the bellows on the piston. This measurement is called the BCR, and is identified in the parts diagrams.

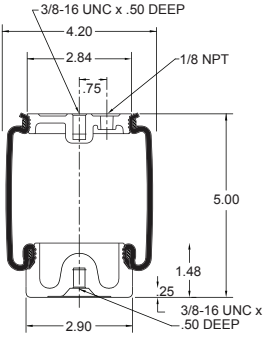



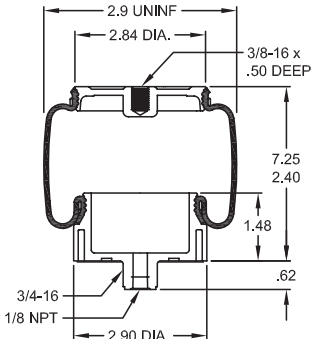

CAB & SEAT

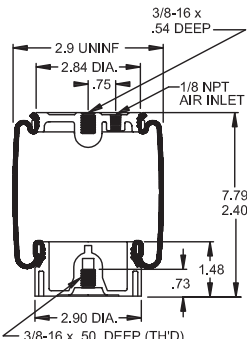

LOGO ORANGE	AON W02-358-7018	 1.02  Aluminum
		<p>APPLICATIONS:</p> <hr/> <p>CAP ID NO. NBD-10183 (7013)</p> <hr/> <p>PISTON ID NO. NBD-10795 (7054)</p> <hr/> <p>BCR \updownarrow 5.00</p>

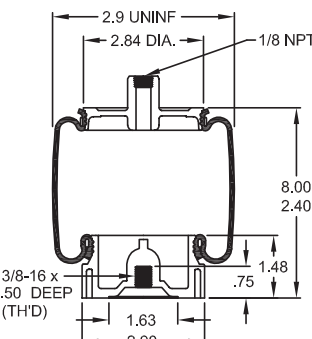

LOGO ORANGE	AON W02-358-7086	 0.61  Composite
		<p>APPLICATIONS:</p> <hr/> <p>LINK MANUFACTURING LTD 1102-0025 (FORD)</p> <hr/> <p>CAP ID NO. NBD-10218 (7018)</p> <hr/> <p>PISTON ID NO. NBD-16538 (6913)</p> <hr/> <p>BCR \updownarrow 5.25</p>

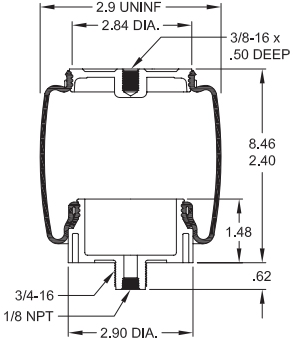

LOGO ORANGE	AON W02-358-7046	 0.70  Composite
		<p>APPLICATIONS:</p> <hr/> <p>LINK MANUFACTURING LTD 1102-0022 (FORD, FRT. GMC, PETE)</p> <hr/> <p>CAP ID NO. NBD-10470 (7068)</p> <hr/> <p>PISTON ID NO. NBD-16537 (6912)</p> <hr/> <p>BCR \updownarrow 6.00</p>

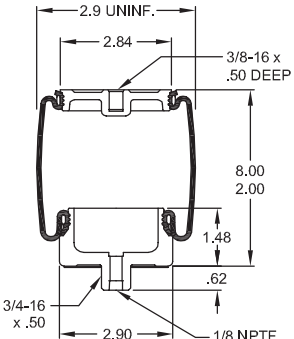
LOGO ORANGE	AON W02-358-7079	 0.65  Composite
		<p>APPLICATIONS:</p> <hr/> <p>LINK MANUFACTURING LTD 1102-0026 (NAV.)</p> <hr/> <p>CAP ID NO. NBD-11636 (7074)</p> <hr/> <p>PISTON ID NO. NBD-16537 (6912)</p> <hr/> <p>BCR \updownarrow 6.00</p>

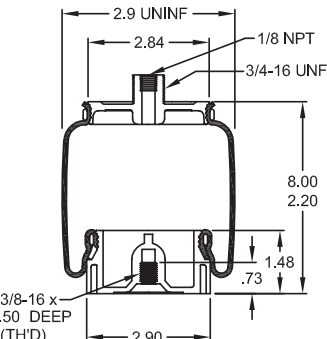

LOGO ORANGE	AON W02-358-7001	 0.69  Composite
		<p>APPLICATIONS:</p> LINK MANUFACTURING LTD 1102-0020 (NAV.) SEE 1102-0023 1102-0023 (FORD, FRT, GMC, KW, NAV., VOLVO) COMFORT RIDE WISE KENWORTH T81-1001
<p>CAP ID NO. NBD-10218 (7018)</p> <hr/> <p>PISTON ID NO. NBD-16538 (6913)</p> <hr/> <p>BCR \updownarrow 6.25</p>		

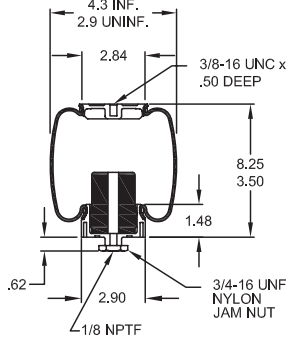

LOGO ORANGE	AON W02-358-7002	 1.04  Aluminum
		<p>APPLICATIONS:</p>
<p>CAP ID NO. NBD-10082 (7014)</p> <hr/> <p>PISTON ID NO. NBD-10549 (7049)</p> <hr/> <p>BCR \updownarrow 6.75</p>		



LOGO ORANGE	AON W02-358-7150	 0.68  Composite
		<p>APPLICATIONS:</p> SEARS / DURAFLEX S13384 (W02-811-7150)
<p>CAP ID NO. NBD-10239 (7015)</p> <hr/> <p>PISTON ID NO. NBD-16537 (6912)</p> <hr/> <p>BCR \updownarrow 7.00</p>		

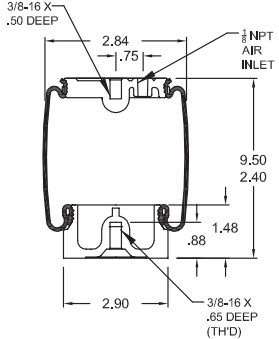

LOGO ORANGE	AON W02-358-7201	 0.89  Composite
		<p>APPLICATIONS:</p> FREIGHTLINER / STERLING 18-45068-000 STERLING DAY CAB OLD FORD # P/N F6HT5C06CAB HN-80 DAY CAB (1996 & LATER)
<p>CAP ID NO. NBD-10218 (7018)</p> <hr/> <p>PISTON ID NO. NBD-16538 (6913)</p> <hr/> <p>BCR \updownarrow 7.25</p>		

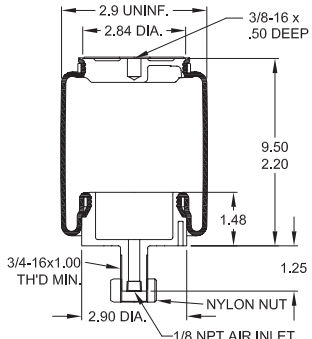

CAB & SEAT

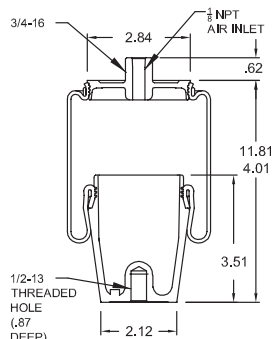

LOGO ORANGE	AON W02-358-7100	 0.71  Composite
		<p>APPLICATIONS: 3-TS W02-T03-7100</p> <hr/> <p>CAP ID NO. NBD-10470 (7068)</p> <hr/> <p>PISTON ID NO. NBD-16537 (6912)</p> <hr/> <p>BCR \updownarrow 7.50</p>

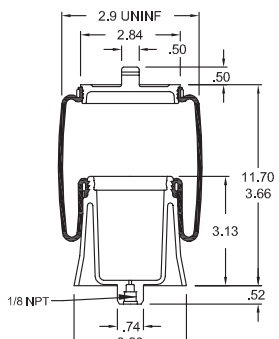

LOGO ORANGE	AON W02-358-7132	 0.76  Composite
		<p>APPLICATIONS: PETERBILT R81-6003</p> <hr/> <p>CAP ID NO. NBD-10218 (7018)</p> <hr/> <p>PISTON ID NO. NBD-16510 (6908)</p> <hr/> <p>BCR \updownarrow 7.50</p>

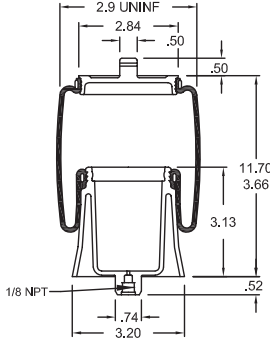

LOGO ORANGE	AON W02-358-7041	 0.90  Composite
		<p>APPLICATIONS: SEARS / DURAFORM S8645 (W02-811-7041)</p> <hr/> <p>CAP ID NO. NBD-10239 (7015)</p> <hr/> <p>PISTON ID NO. FIP-102217 (9636)</p> <hr/> <p>BCR \updownarrow 8.25</p>

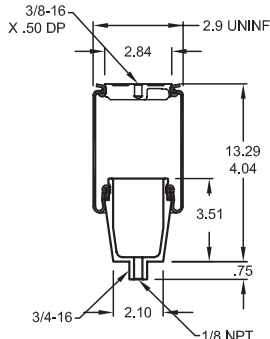
LOGO ORANGE	AON W02-358-7059	 0.90  Composite
		<p>APPLICATIONS: NATIONAL SEATING 324663-01 (W02-N19-7059) 328035-01 (W02-N19-7069) 329666-01 (W02-N19-7084)</p> <hr/> <p>CAP ID NO. NBD-10409 (7042)</p> <hr/> <p>PISTON ID NO. NBD-12708 (6896)</p> <hr/> <p>BCR \updownarrow 8.25</p>

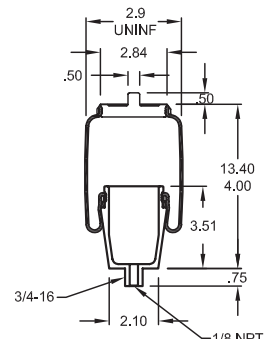

LOGO ORANGE	AON W02-358-7058	 0.94  Composite
		<p>APPLICATIONS: NATIONAL SEATING 324662-01 (W02-N19-7058)</p> <hr/> <p>CAP ID NO. NBD-10409 (7042)</p> <hr/> <p>PISTON ID NO. NBD-12708 (6896)</p> <hr/> <p>BCR \updownarrow 9.00</p>

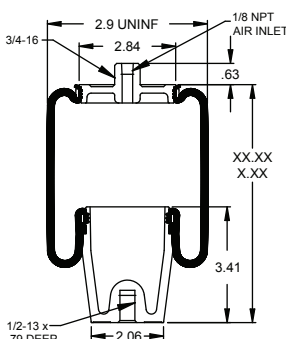

LOGO ORANGE	AON W02-358-7054	 0.90  Composite
		<p>APPLICATIONS: WISE</p> <hr/> <p>CAP ID NO. NBD-10218 (7018)</p> <hr/> <p>PISTON ID NO. FIP-102216 (9638)</p> <hr/> <p>BCR \updownarrow 9.25</p>



LOGO ORANGE	AON W02-358-7098	 0.90  Composite
		<p>APPLICATIONS: LINK MANUFACTURING LTD 1102-0027</p> <hr/> <p>CAP ID NO. NBD-13262 (6997)</p> <hr/> <p>PISTON ID NO. FIP-102216 (9638)</p> <hr/> <p>BCR \updownarrow 9.62</p> <p>OBSELETE: NO LONGER AVAILABLE</p>

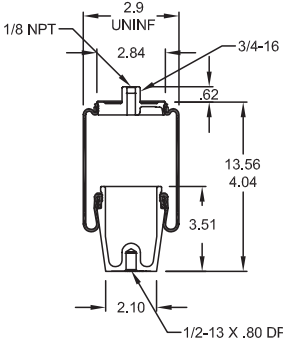

LOGO ORANGE	AON W02-358-7010	 1.44  Aluminum
		<p>APPLICATIONS:</p> <hr/> <p>CAP ID NO. NBD-10010 (7007)</p> <hr/> <p>PISTON ID NO. NBD-10071 (7023)</p> <hr/> <p>BCR \updownarrow 10.00</p>

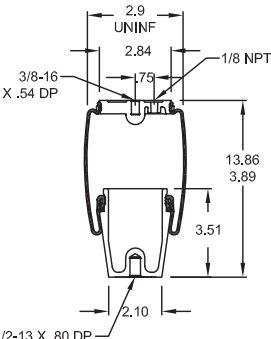
CAB & SEAT

LOGO ORANGE	AON W02-358-7040	 1.06  Composite
		<p>APPLICATIONS: KNOEDLER 7010 AL (USE 7040) (W02-K50-7060) SEARS / DURAFORM S5388 SEATS 707338 AIR FLEX</p>
<hr/> CAP ID NO. NBD-10239 (7015)		
<hr/> PISTON ID NO. FIP-102217 (9636)		
<hr/> BCR \updownarrow 10.00		

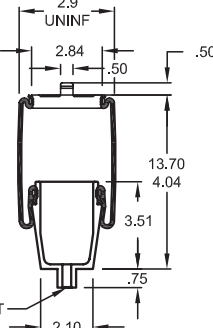
LOGO ORANGE	AON W02-358-7049	 0.98  Composite
		<p>APPLICATIONS: 3-TS W02-T03-7049</p>
<hr/> CAP ID NO. NBD-10470 (7068)		
<hr/> PISTON ID NO. FIP-102217 (9636)		
<hr/> BCR \updownarrow 10.00		
		<p>OBSOLETE: NO LONGER AVAILABLE</p>

LOGO ORANGE	AON W02-358-7055	 0.94  Composite
		<p>APPLICATIONS: NATIONAL SEATING 2112283 7050 PLASTIC (USE 7055)</p>
<hr/> CAP ID NO. NBD-10409 (7042)		
<hr/> PISTON ID NO. FIP-102215 (9637)		
<hr/> BCR \updownarrow 10.00		

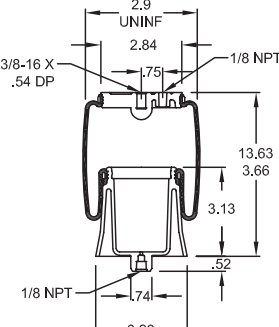
LOGO ORANGE	AON W02-358-7149	 0.97  Composite
		<p>APPLICATIONS: 3-TS W02-T03-7149</p>
<hr/> CAP ID NO. NBD-10470 (7068)		
<hr/> PISTON ID NO. NBD-12708 (6896)		
<hr/> BCR \updownarrow 10.00		

<p>LOGO ORANGE</p>	<p>AON W02-358-7073</p>	<p>1.50 Aluminum</p>
	<p>CAP ID NO. NBD-10183 (7013)</p> <p>PISTON ID NO. NBD-10071 (7023)</p> <p>BCR \updownarrow 11.00</p>	<p>APPLICATIONS: CARE CONCEPT</p> <p>OBSOLETE: NO LONGER AVAILABLE</p>
<p>LOGO GREEN</p>	<p>AON W02-358-7031</p>	<p>1.06 Aluminum</p>
	<p>CAP ID NO. NBD-10082 (7014)</p> <p>PISTON ID NO. NBD-10549 (7049)</p> <p>BCR \updownarrow 7.00</p>	<p>APPLICATIONS: MACK 227QS33 GY 1S4-007</p>
<p>LOGO GREEN</p>	<p>AON W02-358-7209</p>	<p>0.70 Composite</p>
	<p>CAP ID NO. NBD-10409 (7042)</p> <p>PISTON ID NO. FIP-100105 (6979)</p> <p>BCR \updownarrow 7.00</p>	<p>APPLICATIONS: SEATS 708220 NBD-10409 FIP-100105 (W02-812-7209)</p> <p>OBSOLETE: NO LONGER AVAILABLE</p>
<p>LOGO GREEN</p>	<p>AON W02-358-7106</p>	<p>0.90 Composite</p>
	<p>CAP ID NO. NBD-13262 (6997)</p> <p>PISTON ID NO. FIP-102215 (9637)</p> <p>BCR \updownarrow 9.87</p>	<p>APPLICATIONS: LINK MANUFACTURING LTD 1102-0030 (PETE.)</p>

CAB & SEAT

LOGO GREEN	AON W02-358-7085	1.51 Aluminum
		<p>APPLICATIONS: AIR FLEX (W02-A05-7085)</p> <hr/> <p>CAP ID NO. NBD-10183 (7013)</p> <hr/> <p>PISTON ID NO. NBD-10071 (7023)</p> <hr/> <p>BCR \updownarrow 11.50</p>

LOGO RED	AON W02-358-7007	1.06 Aluminum
		<p>APPLICATIONS: MACK 227QS34 GY 1S6-067</p> <hr/> <p>CAP ID NO. NBD-9930 (7005)</p> <hr/> <p>PISTON ID NO. NBD-10549 (7049)</p> <hr/> <p>BCR \updownarrow 6.25</p>

LOGO RED	AON W02-358-7204	2.08 Composite
		<p>APPLICATIONS: FREIGHTLINER / STERLING STERLING ACTERA 18-43472-000</p> <hr/> <p>CAP ID NO. NBD-13706 (6990)</p> <hr/> <p>PISTON ID NO. NBD-16538 (6913)</p> <hr/> <p>BCR \updownarrow 8.00</p>
OBSELETE: NO LONGER AVAILABLE		

LOGO RED	AON W02-358-7080	0.90 Composite
		<p>APPLICATIONS: LINK MANUFACTURING LTD 1102-0031 (FRT.)</p> <hr/> <p>CAP ID NO. NBD-10239 (7015)</p> <hr/> <p>PISTON ID NO. FIP-102217 (9636)</p> <hr/> <p>BCR \updownarrow 10.00</p>

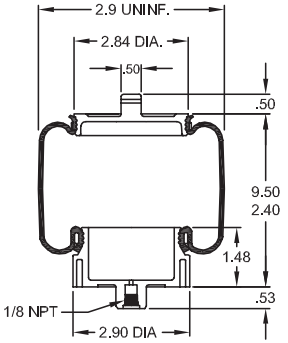
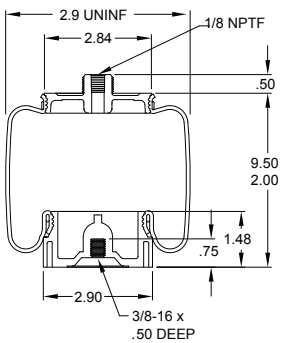
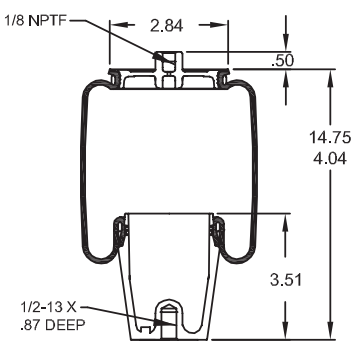
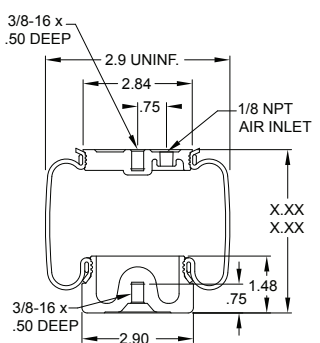
<p>LOGO PINK</p>	<p>AON W02-358-7070</p>	<p>0.69 Composite</p>
	<p>CAP ID NO. NBD-10409 (7042)</p> <p>PISTON ID NO. NBD-16536 (6911)</p> <p>BCR \updownarrow 7.50</p>	<p>APPLICATIONS: NATIONAL SEATING 2123403 (W02-N19-7070) W02-N19-7160</p>
<p>LOGO PINK</p>	<p>AON W02-358-7115</p>	<p>0.70 Composite</p>
	<p>CAP ID NO. NBD-10604 (7050)</p> <p>PISTON ID NO. NBD-16537 (6912)</p> <p>BCR \updownarrow 7.50</p>	<p>APPLICATIONS:</p>
<p>LOGO PINK</p>	<p>AON W02-358-7116</p>	<p>0.95 Composite</p>
	<p>CAP ID NO. NBD-10604 (7050)</p> <p>PISTON ID NO. FIP-102217 (9636)</p> <p>BCR \updownarrow 11.38</p>	<p>APPLICATIONS: LINK MANUFACTURING 1101-0030</p>
<p>LOGO WHITE</p>	<p>AON W02-358-7025</p>	<p>1.08 Aluminum</p>
	<p>CAP ID NO. NBD-10183 (7013)</p> <p>PISTON ID NO. NBD-10795 (7054)</p> <p>BCR \updownarrow 6.50</p>	<p>APPLICATIONS: FREIGHTLINER / WESTERN STAR (STYLE #25 BELLOWS)</p>

CAB & SEAT

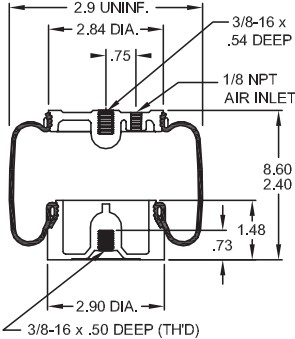
LOGO WHITE	AON W02-358-7035	0.72 Composite
		<p>APPLICATIONS: SEARS / DURAFORM S9383 (W02-811-7035) 7025 AL (USE 7035)</p> <hr/> <p>CAP ID NO. NBD-10470 (7068)</p> <hr/> <p>PISTON ID NO. NBD-16537 (6912)</p> <hr/> <p>BCR \updownarrow 6.50</p>

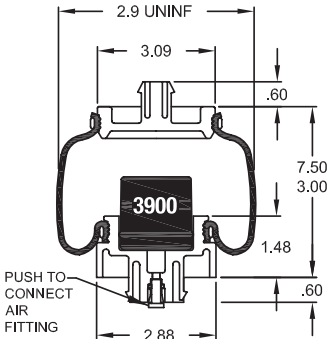

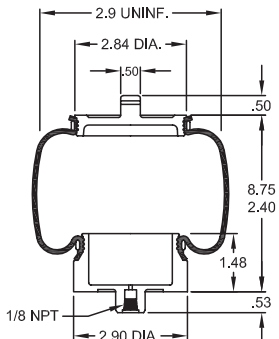
LOGO WHITE	AON W02-358-7206	0.95 Composite
		<p>APPLICATIONS: FREIGHTLINER 18-29919-000 CENTURY CLASS & ARGOSY COE (W02-377-7202) 2002 AND EARLIER</p> <hr/> <p>CAP ID NO. NBD-15430 (6987)</p> <hr/> <p>PISTON ID NO. NBD-15431 (6986)</p> <hr/> <p>BCR \updownarrow 6.50</p> <p style="color: red; font-weight: bold; margin-top: 20px;">REPLACES W02-358-7202</p>

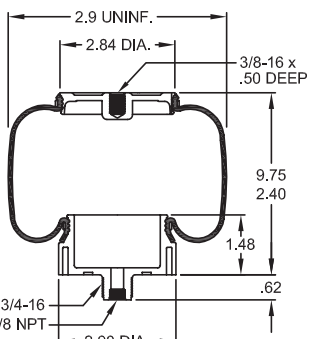

LOGO WHITE	AON W02-358-7087	0.76 Composite
		<p>APPLICATIONS: FREIGHTLINER FLD (1988 & LATER) GY 1S5-040</p> <hr/> <p>CAP ID NO. NBD-10409 (7042)</p> <hr/> <p>PISTON ID NO. NBD-16536 (6911)</p> <hr/> <p>BCR \updownarrow 6.75</p>



LOGO WHITE	AON W02-358-7075	0.71 Composite
		<p>APPLICATIONS: LINK MANUFACTURING LTD 1102-0048</p> <hr/> <p>CAP ID NO. NBD-10218 (7018)</p> <hr/> <p>PISTON ID NO. NBD-16538 (6913)</p> <hr/> <p>BCR \updownarrow 7.75</p>

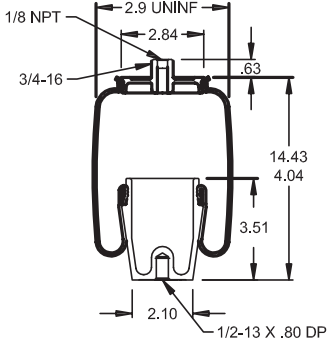

<p>LOGO WHITE</p>	<p>AON W02-358-7037</p>	<p>1.04 Aluminum</p>
	<p>CAP ID NO. NBD-10183 (7013)</p> <p>PISTON ID NO. NBD-10795 (7054)</p> <p>BCR \updownarrow 8.00</p>	<p>APPLICATIONS: AIR FLEX (W02-A05-7037)</p> <p>OBSELETE: NO LONGER AVAILABLE</p>
<p>LOGO WHITE</p>	<p>AON W02-358-7061</p>	<p>0.70 Composite</p>
	<p>CAP ID NO. NBD-10409 (7042)</p> <p>PISTON ID NO. NBD-16538 (6913)</p> <p>BCR \updownarrow 8.00</p>	<p>APPLICATIONS: C. E. WHITE</p>
<p>LOGO WHITE</p>	<p>AON W02-358-7074</p>	<p>0.92 Composite</p>
	<p>CAP ID NO. NBD-13262 (6997)</p> <p>PISTON ID NO. FIP-102216 (9638)</p> <p>BCR \updownarrow 10.12</p>	<p>APPLICATIONS: FREIGHTLINER LINK (1102-0047) LINK MANUFACTURING LTD 1102-0045 1102-0047 (FRT.)</p>
<p>LOGO WHITE</p>	<p>AON W02-358-7012</p>	<p>1.48 Aluminum</p>
	<p>CAP ID NO. NBD-10010 (7007)</p> <p>PISTON ID NO. NBD-10071 (7023)</p> <p>BCR \updownarrow 10.87</p>	<p>APPLICATIONS: LINK MANUFACTURING LTD 1102-0040 RIDE-RITE VANTAGE WHEEL CHAIR</p>

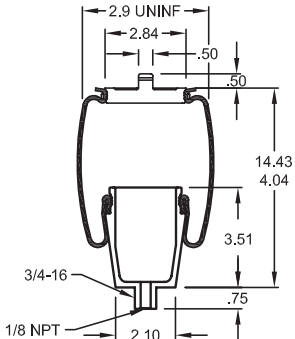
CAB & SEAT

LOGO WHITE	AON W02-358-7042	 1.02  Composite
	<p>CAP ID NO. NBD-10239 (7015)</p> <p>PISTON ID NO. FIP-102217 (9636)</p> <p>BCR \updownarrow 10.87</p>	<p>APPLICATIONS: COMFORT RIDE</p>

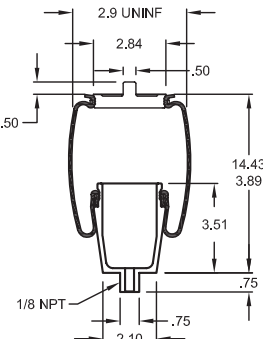
LOGO WHITE	AON W02-358-7045	 0.98  Composite
	<p>CAP ID NO. NBD-10409 (7042)</p> <p>PISTON ID NO. FIP-102216 (9638)</p> <p>BCR \updownarrow 10.87</p>	<p>APPLICATIONS: LINK MANUFACTURING LTD 1102-0042 (WESTERN STAR)</p> <p>OBSELETE: NO LONGER AVAILABLE</p>

LOGO WHITE	AON W02-358-7056	 1.00  Composite
	<p>CAP ID NO. NBD-13262 (6997)</p> <p>PISTON ID NO. FIP-102215 (9637)</p> <p>BCR \updownarrow 10.87</p>	<p>APPLICATIONS: LINK MANUFACTURING LTD 1102-0043 (FRT. KW, MACK)</p>

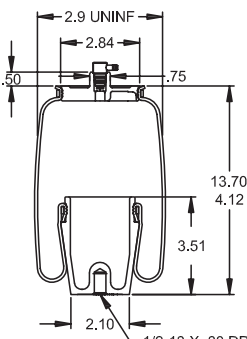
LOGO WHITE	AON W02-358-7208	 0.94  Composite
	<p>CAP ID NO. FIP-100102 (6978)</p> <p>PISTON ID NO. FIP-102217 (9636)</p> <p>BCR \updownarrow 11.12</p>	<p>APPLICATIONS: SEATS 708015 (W02-812-7208)</p>

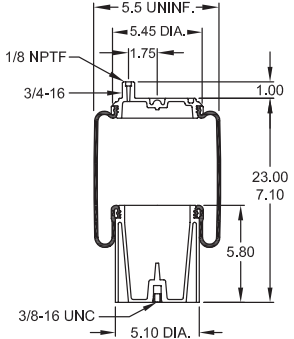
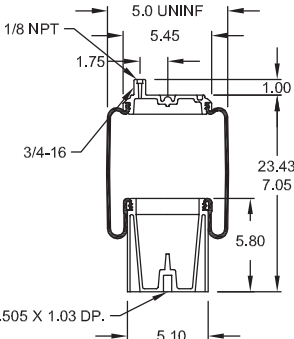
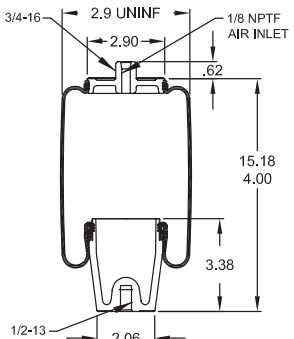
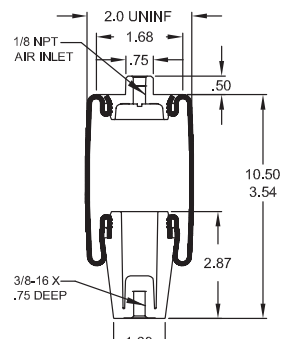
<p>LOGO WHITE</p>	<p>AON W02-358-9904</p>	<p>3.89 Composite</p>
	<p>CAP ID NO. NAD-25400 (7066)</p> <p>PISTON ID NO. NBD-15764 (6980)</p> <p>BCR \updownarrow 16.37</p>	<p>APPLICATIONS: LINK 1103-0504</p>
<p>LOGO WHITE</p>	<p>AON W02-358-9901</p>	<p>3.16 Composite</p>
	<p>CAP ID NO. NAD-25400 (7066)</p> <p>PISTON ID NO. NBD-11340 (7059)</p> <p>BCR \updownarrow 16.67</p>	<p>APPLICATIONS: PETERBILT 02-02031 FRONT AXLE AIR SPRING (PRODUCTION-1989 TO 1992)</p>
<p>LOGO MAROON</p>	<p>AON W02-358-7017</p>	<p>1.54 Aluminum</p>
	<p>CAP ID NO. NBD-10010 (7007)</p> <p>PISTON ID NO. NBD-10071 (7023)</p> <p>BCR \updownarrow 11.50</p>	<p>APPLICATIONS: MACK 227QS38</p>
<p>LOGO YELLOW</p>	<p>AON W02-358-4003</p>	<p>1.01 Aluminum</p>
	<p>CAP ID NO. NBD-10049 (7009)</p> <p>PISTON ID NO. NBD-10514 (7044)</p> <p>BCR \updownarrow 7.25</p>	<p>APPLICATIONS: COMFORT RIDE SEARS / DURAFORM S6197 (W02-811-4003)</p>

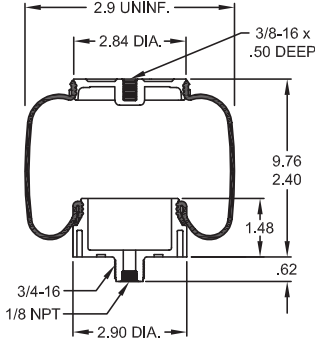

CAB & SEAT

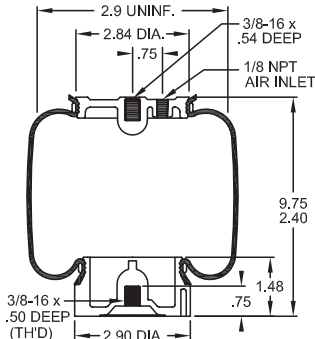

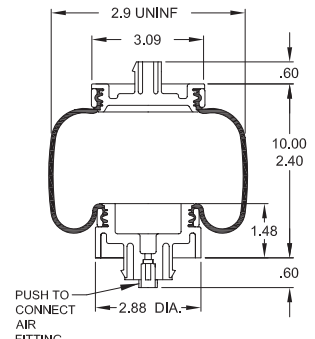
LOGO YELLOW	AON W02-358-7064	0.72 Composite
		<p>APPLICATIONS:</p> <p>KENWORTH KW AEROCAB (MID 1999 & EARLIER) LINK (1102-0074) LINK MANUFACTURING LTD 1102-0074 (KW, MARMON)</p>
CAP ID NO. NBD-10218 (7018)		
PISTON ID NO. NBD-16538 (6913)		
BCR \updownarrow 7.75		

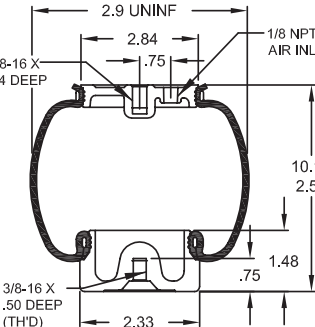

LOGO YELLOW	AON W02-358-7108	0.72 Composite
		<p>APPLICATIONS:</p> <p>LINK MANUFACTURING LTD 1102-0075 (NAV.) MILSCO 07067A GY 1S5-057</p>
CAP ID NO. NBD-10470 (7068)		
PISTON ID NO. NBD-16537 (6912)		
BCR \updownarrow 7.75		

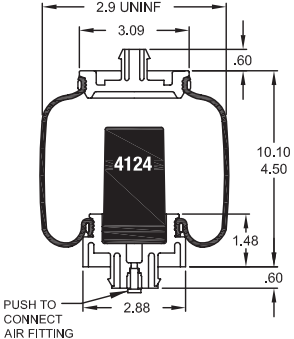

LOGO YELLOW	AON W02-358-7109	0.80 Composite
		<p>APPLICATIONS:</p> <p>KENWORTH KW AEROCAB (MID 1999 & LATER) LINK (1102-0077) LINK MANUFACTURING LTD 1102-0077 (KW) T81-1000 KENWORTH</p>
CAP ID NO. NBD-13706 (6990)		
PISTON ID NO. NBD-14218 (6894)		
BCR \updownarrow 7.87		

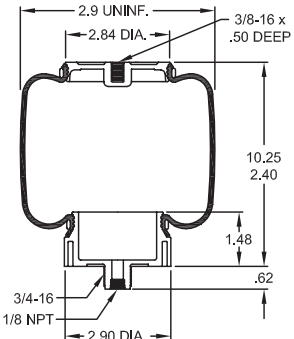
LOGO YELLOW	AON W02-358-7038	1.12 Aluminum
		<p>APPLICATIONS:</p> <p>AIR FLEX 7048 AL (USE 7038) DONVEL</p>
CAP ID NO. NBD-10183 (7013)		
PISTON ID NO. NBD-10795 (7054)		
BCR \updownarrow 8.00		

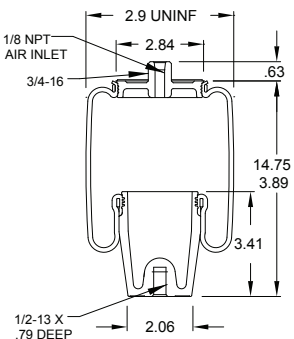

LOGO YELLOW	AON W02-358-7205	 1.10  Composite
		<p>APPLICATIONS: FREIGHTLINER / WESTERN STAR CONSTELLATION</p> <hr/> <p>CAP ID NO. NBD-15430 (6987)</p> <hr/> <p>PISTON ID NO. NBD-15431 (6986)</p> <hr/> <p>BCR \updownarrow 8.00</p> <hr/> <p style="color: red;">REPLACES W02-358-7203</p>

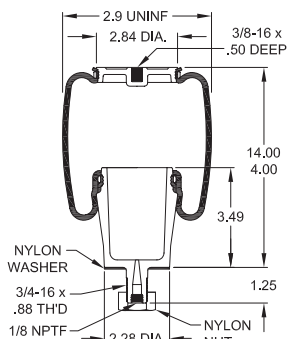

LOGO YELLOW	AON W02-358-7082	 0.82  Composite
		<p>APPLICATIONS: FREIGHTLINER / WESTERN STAR</p> <hr/> <p>CAP ID NO. NBD-10218 (7018)</p> <hr/> <p>PISTON ID NO. NBD-16538 (6913)</p> <hr/> <p>BCR \updownarrow 8.25</p> <hr/>



LOGO YELLOW	AON W02-358-7024	 1.50  Aluminum
		<p>APPLICATIONS: LINK MANUFACTURING LTD 1102-0071</p> <hr/> <p>CAP ID NO. NBD-10010 (7007)</p> <hr/> <p>PISTON ID NO. NBD-10071 (7023)</p> <hr/> <p>BCR \updownarrow 10.00</p> <hr/>

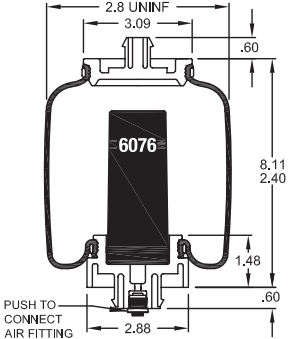

LOGO YELLOW	AON W02-358-7036	 1.53  Aluminum
		<p>APPLICATIONS: PETERBILT 29-03200 UNI-BUILT - HIGHWAY CAB/ SLEEPER 1993 & LATER UNI-BUILT FT SUPPORT SPRING 7155 PETERBILT T81-6000</p> <hr/> <p>CAP ID NO. NBD-10082 (7014)</p> <hr/> <p>PISTON ID NO. NBD-16484 (6906)</p> <hr/> <p>BCR \updownarrow 10.00</p> <hr/>

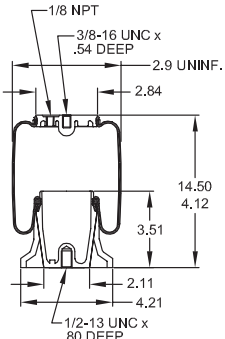
CAB & SEAT

LOGO YELLOW	AON W02-358-7215	 1.31  Composite
		<p>APPLICATIONS: FREIGHTLINER 18-40977-000 CENTURY CLASS ST</p> <hr/> <p>CAP ID NO. NBD-15430 (6987)</p> <hr/> <p>PISTON ID NO. NBD-15431 (6986)</p> <hr/> <p>BCR \updownarrow 10.43</p> <hr/> <p style="color: red; font-weight: bold;">REPLACES W02-358-7111</p>

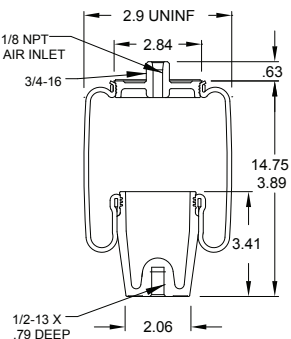
LOGO YELLOW	AON W02-358-7151	 1.30  Composite
		<p>APPLICATIONS: SEARS / DURAFORM S16894 PISTON ADAPTOR 7802/NBD 14989</p> <hr/> <p>CAP ID NO. NBD-10470 (7068)</p> <hr/> <p>PISTON ID NO. FIP-102217 (9636)</p> <hr/> <p>BCR \updownarrow 10.88</p> <hr/> <p style="color: red; font-weight: bold;">OBSOLETE: NO LONGER AVAILABLE</p>

LOGO YELLOW	AON W02-358-7014	 1.52  Aluminum
		<p>APPLICATIONS:</p> <hr/> <p>CAP ID NO. NBD-10010 (7007)</p> <hr/> <p>PISTON ID NO. NBD-10071 (7023)</p> <hr/> <p>BCR \updownarrow 11.50</p> <hr/>

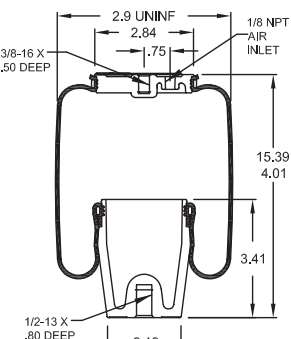
LOGO YELLOW	AON W02-358-7043	 1.48  Aluminum
		<p>APPLICATIONS: DONVEL</p> <hr/> <p>CAP ID NO. NBD-10183 (7013)</p> <hr/> <p>PISTON ID NO. NBD-10071 (7023)</p> <hr/> <p>BCR \updownarrow 11.50</p> <hr/> <p style="color: red; font-weight: bold;">OBSOLETE: NO LONGER AVAILABLE</p>

LOGO YELLOW	AON W02-358-7081	0.92 Composite
		<p>APPLICATIONS:</p> <ul style="list-style-type: none"> NAVISTAR LINK 1102-0076 LINK 1101-0043 GY 1S5-038 LINK MANUFACTURING LTD 1102-0076 (NAV.) NAVISTAR 2501300C1
<p>CAP ID NO. NBD-10604 (7050)</p> <hr/> <p>PISTON ID NO. FIP-102217 (9636)</p> <hr/> <p>BCR \updownarrow 11.50</p>		

LOGO YELLOW	AON W02-358-7139	1.20 Aluminum
		<p>APPLICATIONS:</p>
<p>CAP ID NO. NBD-10082 (7014)</p> <hr/> <p>PISTON ID NO. NBD-16484 (6906)</p> <hr/> <p>BCR \updownarrow 11.50</p>		

LOGO BLUE	AON W02-358-7092	0.78 Composite
		<p>APPLICATIONS:</p> <ul style="list-style-type: none"> KENWORTH KWCSA (LINK 1102-0083) LINK MANUFACTURING LTD 1102-0083 (KW)
<p>CAP ID NO. NBD-10218 (7018)</p> <hr/> <p>PISTON ID NO. NBD-16538 (6913)</p> <hr/> <p>BCR \updownarrow 8.75</p>		

LOGO BLUE	AON W02-358-7093	1.45 Composite
		<p>APPLICATIONS:</p> <ul style="list-style-type: none"> PETERBILT 29-06016 MODEL 387 (NEW IN 1999)
<p>CAP ID NO. NBD-14314 (6991)</p> <hr/> <p>PISTON ID NO. NBD-14589 (6891)</p> <hr/> <p>BCR \updownarrow 10.00</p>		

CAB & SEAT

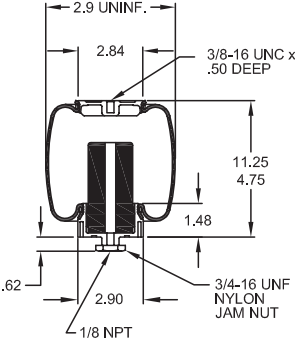
LOGO BLUE	AON W02-358-7200	1.14 Composite
		<p>APPLICATIONS: FREIGHTLINER / STERLING 18-42609-000 STERLING SLEEPER OLD FORD # P/N F6HT5C063BA HN-80 SLEEPER (1996 & LATER)</p>
CAP ID NO. NBD-10218 (7018)		
PISTON ID NO. NBD-16538 (6913)		
BCR \updownarrow 10.25		

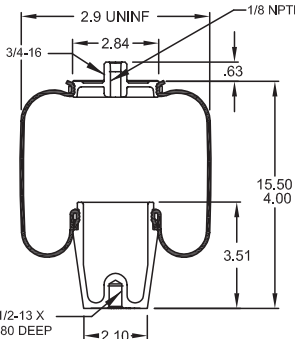
LOGO BLUE	AON W02-358-7083	1.01 Composite
		<p>APPLICATIONS: LINK MANUFACTURING LTD 1102-0081 (FRT.)</p>
CAP ID NO. NBD-10239 (7015)		
PISTON ID NO. FIP-102217 (9636)		
BCR \updownarrow 11.50		

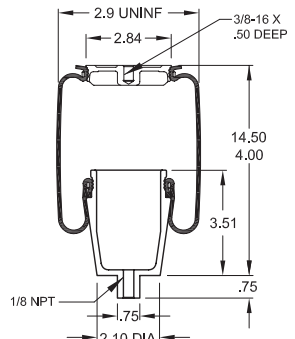
LOGO BLUE	AON W02-358-7110	1.22 Composite
		<p>APPLICATIONS: KENWORTH T2000-1998 & LATER LINK (1102-0082) LINK MANUFACTURING LTD 1102-0082 (KW) 1102-K082 KENWORTH R81-1002</p>
CAP ID NO. NBD-10218 (7018)		
PISTON ID NO. FIP-102215 (9637)		
BCR \updownarrow 11.75		



Steering axle air springs improve handling and stability, reduce wear and fatigue on other components, and enhance ride comfort. Available exclusively from Firestone.

READING THE PARTS TABLE

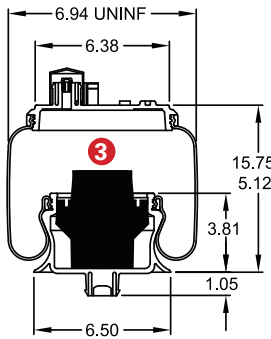
1 CAP COLOR BLUE	2 AON W26-358-9913	6 12.79	7 Composite
	4 CAP ID NO. NAD-30942 (6713)	8 APPLICATIONS: HENDRICKSON TRUCK 60750-2 VOLVO / MACK	
	5 PISTON ID NO. NAD-31336 (6888)		

1. Cap Color

Color of material used on assembly cap.

2. Assembly Order Number (AON)

Located on the label adhered to the assembly cap. This number is used for ordering purposes. It is important that the complete order number is used to avoid any confusion, especially with any type of electronic ordering. The complete order number in this example is W26-358-9913.

3. Cross Section View

Includes dimensional information in inches for **uninflated** diameter and height, as well as component dimensions.

4. Cap Identification Number

Includes the 8-digit cap drawing number and 4-digit cap component number. The 4 digit cap component number might be molded into the perimeter or the top of the air spring cap.

5. Piston Identification Number

Includes the 8-digit piston drawing number and the 4-digit piston component number. The 4 digit piston component number might be molded into the piston, aiding in identification.

6. Weight

The total weight of the spring assembly.

7. Piston Material

Aluminum, Steel, or Composite.

8. Applications

Includes all the information that is known about this specific application (i.e., model number, years of manufacture, part numbers, Firestone reference numbers, and competitor numbers, if known). If you know the vehicle your part came from, this is often the fastest way to identify the Firestone replacement part.

AIR SPRING IDENTIFICATION

Cap Color 1

Identify the cap color to help you narrow down your selections. If no other information is available, visually refer to the part diagrams to identify your part.

Assembly Order Number (AON) 2

The quickest way to identify the air spring is to read the manufacturer or Firestone assembly order number on the label adhered to the bead plate. Do not confuse this with the stamped 8-digit bead plate number.

Cap Identification Number 4

The 4 digit cap component number might be molded into the perimeter or the top of the air spring cap. Do not confuse this 4 digit code with the OE part number, which is also molded onto the perimeter or cap.

OE Part Number 8

The OE part number is stamped on the cap. Reference the Applications section of the part charts to match the OE part number and identify the Firestone AON.

Piston Identification Number 5

The 4 digit piston component number might be molded into the piston, aiding in identification.



BOTTOM VIEW

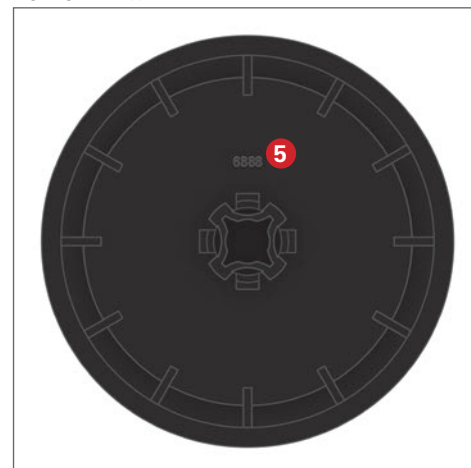

INDUSTRY-LEADING STEERING AXLE SUPPORT
ONLY FROM FIRESTONE



**STEERING AXLE
AIR SPRINGS**

SAFE

Improved handling and stability of the truck/trailer unit via steering axle air suspension.

COMFORTABLE

Enhanced ride for truck driver as air springs absorb road and vehicle vibrations better than standard steel suspension.

EASY

Less maintenance, as air springs reduce overall wear and tear on the suspension and its components.

<p>CAP COLOR ALUMINUM</p>	<p>AON W02-358-9901</p>	<p> 3.20 Composite</p>
	<p>CAP ID NO. NAD-25400 (7066)</p> <p>PISTON ID NO. NBD-11340 (7059)</p>	<p>APPLICATIONS: PETERBILT 02-02031 FRONT AXLE AIR SPRING (PRODUCTION 1989-1992)</p>
<p>CAP COLOR ALUMINUM</p>	<p>AON W26-358-9902</p>	<p> 4.40 Aluminum</p>
	<p>CAP ID NO. NBD-13938 (6700)</p> <p>PISTON ID NO. NBD-13939 (6897)</p>	<p>APPLICATIONS: LINK MANUFACTURING LTD 1102-0080</p>

ABBREVIATIONS INF. - Inflated (Max.) / UNINF. - Uninflated / (P) - Plastic/Composite / (AL) - Aluminum / BCR - Between Clamp Rings / N/A - Not Available

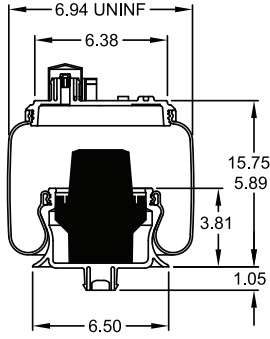
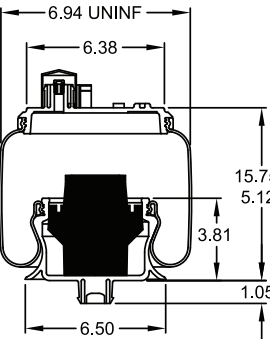
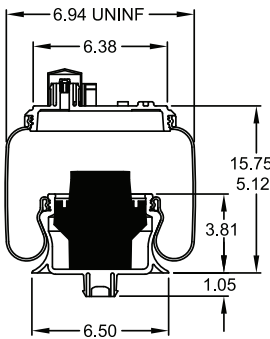
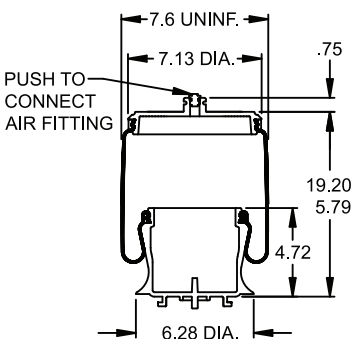
<p>CAP COLOR BLACK</p>	<p>AON W26-358-9911</p>	<p>5.50 Composite</p>
	<p>CAP ID NO. NAD-30942 (6711)</p> <p>PISTON ID NO. NAD-30940 (6890)</p>	<p>APPLICATIONS: HENDRICKSON TRUCK 59823-2 FREIGHTLINER / WESTERN STAR</p>
<p>CAP COLOR BEIGE</p>	<p>AON W26-358-9912</p>	<p>4.90 Composite</p>
	<p>CAP ID NO. NAD-30942 (6714)</p> <p>PISTON ID NO. NAD-31336 (6888)</p>	<p>APPLICATIONS: HENDRICKSON TRUCK 64075-2 BLUE BIRD BUS</p>
<p>CAP COLOR BLUE</p>	<p>AON W26-358-9913</p>	<p>4.90 Composite</p>
	<p>CAP ID NO. NAD-30942 (6713)</p> <p>PISTON ID NO. NAD-31336 (6888)</p>	<p>APPLICATIONS: HENDRICKSON TRUCK 60750-2 VOLVO / MACK</p>
<p>CAP COLOR BLACK</p>	<p>AON W26-358-9933</p>	<p>4.70 Composite</p>
	<p>CAP ID NO. FIP-100913 (6975)</p> <p>PISTON ID NO. FIP-100912 (6885)</p>	<p>APPLICATIONS: PACCAR B81-6023</p>

PRIMARY TRUCK & TRAILER, AUXILIARY /TAG AXLE

MANUFACTURER TO FIRESTONE NUMBER

MANUFACTURER/ PART NO.	FIRESTONE ASSEMBLY ORDER NO.	PAGE NO.
3TS		
	W02-358-7103	Call us
AG CHEM		
24869	W01-358-9036	34
50026	W01-358-7512	114
50069	W01-358-7146	106
522285	W01-358-8092	89
AGCO		
24869	W01-358-9036	34
50026	W01-358-7512	114
50069	W01-358-7146	106
522285	W01-358-8092	89
AIR AX (ROELOFS)		
	W01-358-9953	32
AMERICAN CARRIER		
8003001	W01-358-5310	12
8003003	W01-358-9421	66
8003005	W01-358-7146	106
8003006	W01-358-7325	113
8003007	W01-358-7105	Call us
8003009	W01-358-3400	116
8003011	W01-358-5412	14
8003013	W01-358-7093	97
8003023	W01-358-5766	65
8003024	W01-358-5765	Call us
8003025	W01-358-9290	30
8003026	W01-358-3402	116
BELLE TRAILERS		
BT0094	WC1-358-9454	Call us
BT0319	W01-358-9082	46
BT0321	W01-358-9039	34
BELOIT		
274833011	W01-358-9149	83
274852004	W01-358-7103	97
274853D0010019	W01-358-7230	115
274853D0020001	W01-358-7271	114
274853D0020002	W01-358-7276	124
274855D0010005	W01-358-7230	115
274855D0010008	W01-358-7761	122

MANUFACTURER/ PART NO.	FIRESTONE ASSEMBLY ORDER NO.	PAGE NO.
274855D0010009	W01-358-7304	124
274855D0010010	W01-358-7761	122
274855D0020002	W01-358-7276	124
52204-007	W01-358-7180	108
52204-008	W01-358-7185	109
52204-019	W01-358-7145	106
52204-025	W01-358-6910	100
52206-008	W01-358-7304	124
P4-13664-0-1	W01-358-7001	96
P4-13664-0-2	W01-358-7011	97
P4-13664-0-3	W01-358-6900	99
P4-13664-1-10	W01-358-7025	119
P4-13664-1-17	W01-358-7325	113
P4-13664-2-21	W01-358-7008	96
P4-13664-2-24	W01-358-3400	116
P4-13664-3-46	W01-358-7325	113
BERTOJA		
45402002	W01-M58-8775	88
BINKLEY		
XBSPN05337	W01-358-7555	117
XBSPN05360	W01-358-8204	36
BLUE BIRD		
990671	W01-358-9073	29
1263581	W01-358-8997	19
1286814	W01-358-9457	21
300091425	W01-358-8997	19
300961250	W01-358-9039	34
590312B	W01-358-9641	54
BRAKE & WHEEL		
M3500	W01-358-6902	99
M3501	W01-358-6910	100
M3502	W01-358-7135	106
M3503	W01-358-7136	106
M3505	W01-358-7145	106
M3506	W01-358-7400	109
M3507	W01-358-7403	110
M3508	W01-358-7410	111
M3509	W01-358-7424	111
M3510	W01-358-8050	91
M3511	W01-358-9039	34

PRIMARY TRUCK & TRAILER, AUXILIARY / TAG AXLE
MANUFACTURER TO FIRESTONE NUMBER

MANUFACTURER/ PART NO.	FIRESTONE ASSEMBLY ORDER NO.	PAGE NO.
M3512	W01-358-9069	42
M3513	W01-358-9082	46
M3514	W01-358-9083	46
M3515	W01-358-9101	57
M3516	W01-358-9105	38
M3517	W01-358-9121	82
M3518	W01-358-9122	85
M3519	W01-358-9130	57
M3520	W01-358-9158	86
M3521	W01-358-9177	83
M3522	W01-358-9213	48
M3523	W01-358-9241	58
M3524	W01-358-9265	61
M3525	W01-358-9422	19
M3526	W01-358-9466	49
M3527	W01-358-6994	96
M3528	W01-358-6897	99
M3530	WC1-358-0361	Call us
M3531	W01-358-7555	117
M3533	W01-358-7808	124
M3534	W01-358-5410	14
M3535	W01-358-8052	91
M3536	W01-358-9075	Call us
M3538	W01-358-9192	57
M3539	W01-358-9194	47
M3540	W01-358-9219	48
M3541	W01-358-9243	58
M3542	W01-358-9270	71
M3543	W01-358-9293	32
M3544	W01-358-9295	33
M3545	W01-358-9321	60
M3546	W01-358-9394	59
M3547	W01-358-9421	66
M3548	W01-358-9923	51
M3550	W01-358-9780	72
CAPACITY OF TEXAS		
	W01-358-5712	17
CATERPILLAR		
1029283	W01-358-9278	64
1416046	W01-358-8235	Call us
	W01-358-9278	64

MANUFACTURER/ PART NO.	FIRESTONE ASSEMBLY ORDER NO.	PAGE NO.
CHALMERS		
07R00005	W01-358-9342	50
	W01-358-7094	98
CHANCE MFG		
23891728	W01-358-9459	22
27003376	W01-358-8990	Call us
27003377	W01-358-9105	38
CIRCLE R		
	W01-358-5422	14
DANA		
SR1VA101	W01-358-8539	80
SR1VA105	W01-358-8539	80
DART		
214048	W01-358-9135	82
1001404	W01-358-7244	115
1016031	W01-358-7294	Call us
1016034	W01-358-9135	82
2140057	W01-358-7244	115
2140061	W01-358-7294	Call us
DAYTON PARTS		
3528050	W01-358-8050	91
3529010	W01-358-9010	41
3529011	W01-358-9011	Call us
3529039	W01-358-9039	34
3529053	W01-358-9053	38
3529069	W01-358-9069	42
3529082	W01-358-9082	46
3529083	W01-358-9083	46
3529096	W01-358-9096	47
3529101	W01-358-9101	57
3529105	W01-358-9105	38
3529121	W01-358-9121	82
3529122	W01-358-9122	85
3529130	W01-358-9130	57
3529148	W01-358-9148	83
3529149	W01-358-9149	83
3529158	W01-358-9158	86
3529177	W01-358-9177	83
3529192	W01-358-9192	57

PRIMARY TRUCK & TRAILER, AUXILIARY /TAG AXLE

MANUFACTURER TO FIRESTONE NUMBER

MANUFACTURER/ PART NO.	FIRESTONE ASSEMBLY ORDER NO.	PAGE NO.
3529194	W01-358-9194	47
3529200	W01-358-9200	80
3529203	W01-358-9203	57
3529213	W01-358-9213	48
3529215	W01-358-9215	81
3529227	W01-358-9227	48
3529238	W01-358-9238	58
3529321	W01-358-9321	60
3529349	W01-358-9349	Call us
3529415	W01-358-9415	24
3529422	W01-358-9422	19
3546801	W01-358-6801	107
3546803	W01-358-6803	107
3546902	W01-358-6902	99
3546905	W01-358-6905	100
3546910	W01-358-6910	100
3546947	W01-358-6947	105
3547112	W01-358-7112	98
3547123	W01-358-7123	105
3547135	W01-358-7135	106
3547136	W01-358-7136	106
3547140	W01-358-7140	106
3547145	W01-358-7145	106
3547146	W01-358-7146	106
3547181	W01-358-7181	108
3547400	W01-358-7400	109
3547403	W01-358-7403	110
3547404	W01-358-7404	110
3547405	W01-358-7405	110
3547410	W01-358-7410	111
3547424	W01-358-7424	111
3547429	W01-358-7429	111
3547437	W01-358-7437	111
3547443	W01-358-7443	112
3547446	W01-358-7446	112
3547447	W01-358-7447	112
3547798	W01-358-7798	123
3547800	W01-358-7800	123
3547808	W01-358-7808	124

MANUFACTURER/ PART NO.	FIRESTONE ASSEMBLY ORDER NO.	PAGE NO.
3547818	W01-358-7818	124
3547839	W01-358-7839	125
3547843	W01-358-7843	125
3547846	W01-358-7846	125
3547847	W01-358-7847	125
3548008	W01-358-8008	120
DINA		
A1812719	W01-358-6900	99
A1Z812719	W01-358-6900	99
A812719	W01-358-6910	100
AZ812719	W01-358-6910	100
DUNLOP		
D12B17	W01-M58-7074	62
D13B02	W01-M58-6339	86
D13B26	W01-M58-6348	89
PNP311770000	W01-M58-6339	86
PNP311780000	W01-M58-8775	88
DURA FORM		
S5388	W02-358-7010	133
E.R.F.		
1392754	W01-358-9101	57
1398550	W01-358-9580	79
1398567	W01-358-7325	113
1426481	W01-358-7403	110
1439083	W01-M58-6339	86
ELDORADO BUS		
7089E000	W01-358-9448	21
71040301	W01-358-8997	19
7113D000	W01-358-5414	14
EZ RIDE		
8030120	W01-358-6905	100
8030150	W01-358-7447	112
8030155	W01-358-8008	120
8030160	W01-358-6801	107
8030170	W01-358-7808	124
8030180	W01-358-7818	124
8030190	W01-358-7180	108
8030192	W01-358-9053	38

PRIMARY TRUCK & TRAILER, AUXILIARY / TAG AXLE
MANUFACTURER TO FIRESTONE NUMBER

MANUFACTURER/ PART NO.	FIRESTONE ASSEMBLY ORDER NO.	PAGE NO.
FAB TEK		
40080	W01-358-7400	109
101243	W01-358-9072	Call us
101357	W01-358-9071	42
101827	W01-358-9039	34
FLXIBLE		
63362	W01-358-5310	12
63367	W01-358-9410	Call us
63791	W01-358-5311	12
63792	W01-358-9031	34
633611	W01-358-5406	13
6304156	W01-358-5710	17
6304156	W01-358-5730	16
6336175	W01-358-5710	17
6336175	W01-358-5730	16
6336195	W01-358-8990	Call us
6336196	W01-358-8997	19
6336200	W01-358-9441	24
6336202	W01-358-9039	34
6336205	W01-358-9105	38
6336212	W01-358-9073	29
6336215	W01-358-9230	Call us
6336217	W01-358-9280	83
97240153	W01-358-9017	29
97999902185	W01-358-9306	35
FODEN		
1300248000	W01-358-9069	42
1300335000	W01-358-9402	65
FORD		
E9HZ5580A	W01-358-9466	49
F2HZ5580A	W01-358-9287	53
F3HS5580AA	W01-358-9335	43
FOHZ5580A	W01-358-9287	53
FREIGHTLINER		
161673000	W01-358-9780	72
161975800	W01-358-9780	72
1610796000	W01-358-7400	109
1611378000	W01-358-7410	111
1613810000	W01-358-9780	72

MANUFACTURER/ PART NO.	FIRESTONE ASSEMBLY ORDER NO.	PAGE NO.
1613810001	W01-358-9780	72
1613810001	W01-358-9782	72
1613810002	W01-358-9780	72
1613810002	W01-358-9780	72
1613840000	W01-358-9781	72
1614263000	W01-358-9634	63
1614263001	W01-358-9634	63
1614377000	W01-358-9780	72
1615443000	W01-358-9634	63
1615443001	W01-358-9634	63
1615444000	W01-358-9634	63
1615762000	W01-358-9774	Call us
1616019000	W01-358-8207	Call us
1616773000	W01-358-9781	72
1616773000	W01-358-9782	72
1619465000	W01-358-9781	72
1619466000	W01-358-9781	72
1619467000	W01-358-9780	72
1619468000	W01-358-9780	72
1619469000	W01-358-9782	72
1619470000	W01-358-9634	63
1619471000	W01-358-9774	Call us
1619769000	W01-358-9780	72
6813200017	W01-358-9781	72
16-10769-000	W01-358-7400	109
16-11378-000	W01-358-7410	111
16-13810-000	W01-358-9780	72
16-13810-000 / 16-13810-001 / 16-13810-002 / 681-320-0017 / A16-14004-000 / A16-14004-001	W01-358-9780	72
16-13810-001	WC1-358-3900	92
16-13810002	WC1-358-3901	92
16-14365-001	WC1-358-3901	92
16-15443-000	W01-358-9634	63
16-15762-000	W01-358-9774	Call us
681-320-0017	W01-358-9780	72
681-320-0017	W01-358-9781	72

PRIMARY TRUCK & TRAILER, AUXILIARY /TAG AXLE

MANUFACTURER TO FIRESTONE NUMBER

MANUFACTURER/ PART NO.	FIRESTONE ASSEMBLY ORDER NO.	PAGE NO.
681-320-0017, A16-14004-000 (aluminum) Freightliner Piston 16-13840-000 (plastic) - See W01-358-9780 Freightliner Piston 16-16773-000 (steel) - See W01-358-9782	W01-358-9781	72
A16-14004-000	WC1-358-3900	92
A16-14004-001	WC1-358-3901	92
A1613668002	W01-358-9780	72
A1614004000	W01-358-9782	72
A1614004001	W01-358-9780	72
A1617574000	W01-358-9781	72
A1617574001	W01-358-9781	72
A1617574002	W01-358-9781	72
A1617592000	W01-358-9782	72
A1618333000	W01-358-9634	63
A1618333001	W01-358-9634	63
A1618334000	W01-358-9774	Call us
A1618334001	W01-358-9774	Call us
A1618335000	W01-358-9780	72
A1618335001	W01-358-9780	72
A1620111000	W01-358-9780	72
A1620111001	W01-358-9780	72
FRUEHAUF		
8030160	W01-358-6801	107
8030170	W01-358-7808	124
8030180	W01-358-7818	124
8030190	W01-358-7180	108
8030192	W01-358-9053	38
003615E	W01-M58-6339	86
MFR022354	W01-358-9077	Call us
MFR022355	W01-358-9078	38
UAB5620	W01-358-7181	108
UCA0112	W01-358-7183	109
UCA0112B	W01-358-7183	109
UCB44531	W01-358-9077	Call us
UCB96681	W01-358-9078	38

MANUFACTURER/ PART NO.	FIRESTONE ASSEMBLY ORDER NO.	PAGE NO.
UCC30541	W01-358-7181	108
UCD93932	W01-358-9394	59
UCE12304001	W01-358-9096	47
UCE13041	W01-358-9096	47
UCE13042	W01-358-9053	38
UCE93931	W01-358-9130	57
UCE93932	W01-358-9394	59
UCE93933	W01-358-9394	59
UCE93934	W01-358-9394	59
GENERAL COACH		
	W01-358-5335	15
	W01-358-9592	30
GILLIG		
5313187	W01-358-9441	24
5314006	W01-358-9441	24
5314007	W01-358-9230	Call us
5320415	W01-358-8053	91
5502168	W01-358-7001	96
8717289	W01-358-9325	39
5309611001	W01-358-9070	42
5317602001	W01-358-9082	46
53204150001	W01-358-8053	91
0837209O00N	W01-358-5298	18
GMC		
661755	W01-358-5710	17
661755	W01-358-5730	16
661758	W01-358-5710	17
662743	W01-358-5406	13
665260	W01-358-5730	16
665621	W01-358-9017	29
667302	W01-358-9017	29
684192	W01-358-9017	29
684193	W01-358-9017	29
693230	W01-358-7400	109
698634	W01-358-5730	16
698934	W01-358-5730	16
698935	W01-358-9017	29
711954	W01-358-7401	109
716111	W01-358-5406	13
2076095	W01-358-7401	109

PRIMARY TRUCK & TRAILER, AUXILIARY / TAG AXLE
MANUFACTURER TO FIRESTONE NUMBER

MANUFACTURER/ PART NO.	FIRESTONE ASSEMBLY ORDER NO.	PAGE NO.
2354547	WC1-358-3622	Call us
2354549	WC1-358-3626	Call us
2376039	W01-358-5710	17
2376039	W01-358-5730	16
2383256	W01-358-5730	16
2383257	W01-358-9017	29
8865456	W01-358-5406	13
8870484	W01-358-5710	17
8870484	W01-358-5730	16
15963160	W01-358-9287	53
661758A	W01-358-5730	16
661758C	W01-358-5730	16
661759A	W01-358-9017	29
661759C	W01-358-9017	29
68419C	W01-358-9017	29
684242C	W01-358-9017	29
G5008051	W01-358-5730	16
G5008052	W01-358-9017	29
HAGIE MANUFACTURING / WAGGONER'S TRUCK		
	W01-358-9439	24
HENDRICKSON		
1015	W01-358-8042	127
1285	W01-358-7859	Call us
1346	W01-358-7797	123
1347	W01-358-7505	114
1475	W01-358-7790	113
1503	W01-358-6789	Call us
1795	W01-358-7862	126
1796	W01-358-7545	116
2286	W01-358-8971	33
2348	W01-358-7954	126
2873	W01-358-7897	103
2878	W01-358-7897	103
3316	W01-358-8033	122
3317	W01-358-7795	102
3318	W01-358-6935	101
3319	W01-358-9367	60
4647	W01-358-3420	118
4828	W01-358-7872	126
5079	W01-358-7659	114

MANUFACTURER/ PART NO.	FIRESTONE ASSEMBLY ORDER NO.	PAGE NO.
5360	W01-358-7891	102
20716	W01-358-9299	64
28929	W01-358-8708	78
48195	W01-358-9227	48
49048	W01-358-9466	49
49207	W01-358-9466	49
49674	W01-358-9466	49
50405	W01-358-9287	53
50898	W01-358-9297	53
50899	W01-358-9375	54
56916	W01-358-9284	Call us
56917	W01-358-9335	43
57140	W01-358-9339	39
57839	W01-358-8868	16
59319	W01-M58-8712	78
365141	W01-358-7403	110
365143	W01-358-9302	Call us
365144	W01-358-9158	86
365145	W01-358-7472	116
365147	W01-358-9082	46
365148	W01-358-9122	85
481951	W01-358-9227	48
490482	W01-358-9466	49
496741	W01-358-9466	49
496742	W01-358-9466	49
504051	W01-358-9287	53
504052	W01-358-9287	53
508981	W01-358-9297	53
508982	W01-358-9297	53
508991	W01-358-9375	54
508992	W01-358-9375	54
568082	W01-358-9339	39
569162	W01-358-9284	Call us
569171	W01-358-9335	43
569172	W01-358-9335	43
571222	W01-358-9373	53
579202	W01-358-8868	16
579652	W01-358-8868	16
585202	W01-M58-9372	55
587862	W01-358-9647	54

PRIMARY TRUCK & TRAILER, AUXILIARY /TAG AXLE

MANUFACTURER TO FIRESTONE NUMBER

MANUFACTURER/ PART NO.	FIRESTONE ASSEMBLY ORDER NO.	PAGE NO.
588492	W01-358-8938	37
589832	W01-358-8942	Call us
589952	W01-358-9643	64
590312	W01-358-8941	23
593192	W01-M58-8712	78
594842	W01-358-8971	33
596012	W01-358-8972	Call us
602712	W01-358-9663	55
607162	W01-358-9554	28
609252	W01-358-8817	41
609292	W01-358-8816	41
644892	W01-M58-9372	55
646512	W01-M58-9656	55
649172	W01-358-9647	54
650322	W01-358-9654	54
650862	W01-M58-9851	60
657902	W01-358-8597	28
666432	W01-358-8673	76
670432	W01-358-9865	71
672342	W01-358-8109	77
673912	W01-358-9866	71
698132	W01-358-8723	74
3651410	W01-358-9122	85
3651411	W01-358-9158	86
3651412	W01-358-8052	91
3651413	W01-358-8050	91
20462941	W01-358-9554	28
25158024	W01-358-9375	54
25173621	W01-M58-9656	55
49048000	W01-358-9466	49
58541002	W01-358-8916	23
59484002	W01-358-8971	33
64489002	W01-M58-9372	55
67234002	W01-358-8109	77
98734003	W01-358-9249	68
98734016	W01-358-9017	29
002286/594842	W01-358-8971	33
1R12275	W01-358-9240	58
1R12365	W01-358-9466	49

MANUFACTURER/ PART NO.	FIRESTONE ASSEMBLY ORDER NO.	PAGE NO.
1R12366	W01-358-8944	61
1R12375	W01-358-9265	61
1R13039	W01-358-9228	Call us
1R13118	W01-358-9580	79
1R14172	W01-358-8774	90
1S12027	W01-358-9287	53
1S12030	W01-358-9373	53
2B10226	W01-358-7795	102
45843-1	W01-358-6905	100
45843-3	W01-358-6910	100
48195-2	W01-358-9223	48
57122-2	W01-358-9373	53
57140LH	W01-358-9339	39
57150RH	W01-358-9339	39
57QL411M	W01-358-9466	49
57QL414M	W01-358-9375	54
57QL53M	W01-M58-9656	55
57QL57M	W01-358-9663	55
585202D	W01-M58-9372	55
586542B	W01-M58-9372	55
590102B	W01-358-9641	54
59319-2	W01-M58-8712	78
609252C	W01-358-8817	41
64651-2	W01-358-9297	53
B-12514-013	W01-358-8051	Call us
B-12514-013 (Canada)	W01-358-5523	90
B12514001	W01-358-7403	110
B12514003	W01-358-9302	Call us
B12514004	W01-358-9158	86
B12514005	W01-358-7472	116
B12514007	W01-358-9082	46
B12514008	W01-358-9122	85
B12514010	W01-358-9122	85
B12514011	W01-358-9158	86
B12514012	W01-358-8052	91
B12514013	W01-358-8050	91
B12514014	W01-358-7135	106
B13161	W01-358-9130	57
B2063	W01-M58-6339	86

PRIMARY TRUCK & TRAILER, AUXILIARY / TAG AXLE
MANUFACTURER TO FIRESTONE NUMBER

MANUFACTURER/ PART NO.	FIRESTONE ASSEMBLY ORDER NO.	PAGE NO.
B2065	W01-M58-8775	88
B2827	W01-358-9010	41
B3411	W01-358-9228	Call us
B3842	W01-358-9101	57
C20127	W01-358-9580	79
C20223	W01-358-9640	63
C20413	W01-358-9265	61
C21623	W01-358-8755	75
C21624	W01-358-8756	Call us
D22697	W01-358-8724	76
HA100095	W01-358-7472	116
HA360	W01-358-9466	49
HA400	W01-358-9466	49
HA460	W01-358-9466	49
HS506500	W01-358-9580	79
HT-250T	W01-358-9265	61
HT-250U	W01-358-9265	61
HT-250U-Y	W01-358-9265	61
HT250U	W01-358-9580	79
HT250UY	W01-358-9580	79
NA1060	W01-358-7403	110
NA1816	W01-358-7180	108
NA1817	W01-358-9130	57
NA1821	W01-358-7325	113
NA1825	W01-358-7472	116
NA1827	W01-358-7447	112
NS501304	W01-358-9321	60
NS501690	W01-358-8008	120
NS502049	W01-358-9287	53
S-4771 (trailer)	W01-358-5523	90
S1013	W01-358-7400	109
S10170	W01-358-7410	111
S10352	W01-358-9240	58
S10352	W01-358-9394	59
S10443	W01-358-9101	57
S1080	W01-358-7136	106
S11566	W01-358-9010	41
S1159	W01-358-7403	110
S11637	W01-358-8008	120
S11650	W01-358-9039	34

MANUFACTURER/ PART NO.	FIRESTONE ASSEMBLY ORDER NO.	PAGE NO.
S11651	W01-358-9082	46
S12335	W01-358-7472	116
S12353	W01-358-9092	46
S12405	W01-358-8032	122
S12437	W01-358-9122	85
S1245	W01-358-9105	38
S13031	W01-358-9069	42
S13032	W01-358-9422	19
S13033	W01-358-9213	48
S13034	W01-358-7135	106
S13035	W01-358-7443	112
S13036	W01-358-7410	111
S13037	W01-358-7437	111
S13038	W01-358-7145	106
S13039	W01-358-7798	123
S13040	W01-358-9073	29
S13040	W01-358-9415	24
S13041	W01-358-7818	124
S13042	W01-358-9083	46
S13043	W01-358-7424	111
S13044	W01-358-7112	98
S13045	W01-358-9149	83
S13046	W01-358-7146	106
S13047	W01-358-7800	123
S13047	W01-358-7848	126
S13048	W01-358-7123	105
S13049	W01-358-9096	47
S13050	W01-358-7181	108
S13052	W01-358-7429	111
S13053	W01-358-9148	83
S13055	W01-358-7443	112
S13122	W01-358-9264	88
S13154	W01-358-5311	12
S13155	W01-358-5414	14
S13157	W01-358-7808	124
S13158	W01-358-9053	38
S13160	W01-358-9121	82
S13161	W01-358-9130	57
S13163	W01-358-9194	47
S1345	W01-358-7404	110

PRIMARY TRUCK & TRAILER, AUXILIARY /TAG AXLE

MANUFACTURER TO FIRESTONE NUMBER

MANUFACTURER/ PART NO.	FIRESTONE ASSEMBLY ORDER NO.	PAGE NO.
S14147	W01-358-9652	31
S14249	W01-358-9367	60
S14318	W01-358-6935	101
S14395	W01-358-7325	113
S14486	W01-358-7795	102
S14487	W01-358-8033	122
S14795	W01-358-8043	127
S1561	W01-358-9083	46
S20010	W01-358-9270	71
S20124	W01-358-9265	61
S20127	W01-358-9580	79
S20157	W01-358-9928	88
S20217	W01-358-8944	61
S20223	W01-358-9640	63
S20413	W01-358-9265	61
S20414	W01-358-9581	79
S2063	W01-358-9158	86
S2064	W01-358-9039	34
S2064/S11650	W01-358-9039	34
S2065	W01-358-9177	83
S2066	W01-358-9082	46
S20716	W01-358-9299	64
S20900	W01-358-8709	78
S20901	W01-358-8091	89
S21208	W01-358-8800	71
S21323	W01-358-6962	105
S21623	W01-358-8755	75
S21624	W01-358-8710	79
S21784	W01-358-8091	89
S21800	W01-358-8709	78
S21966	W01-358-8708	78
S22045	W01-358-8755	75
S22046	W01-358-8710	79
S22173	W01-358-5511	87
S22697	W01-358-8724	76
S22948	W01-358-8713	78
S2307	W01-358-9011	Call us
S23114	W01-358-7897	103
S23321	WC1-358-1694	Call us
S23611	W01-358-9646	61

MANUFACTURER/ PART NO.	FIRESTONE ASSEMBLY ORDER NO.	PAGE NO.
S23612	W01-358-9645	61
S23613	W01-358-9621	27
S23614	W01-358-9619	28
S23720	W01-358-9626	25
S23721	W01-358-9644	61
S23748	W01-358-8093	89
S2394	W01-358-2119	12
S24443	W01-358-8093	89
S25559	W01-358-9270	71
S25873	W01-358-8774	90
S2630	W01-358-6902	99
S26773	W01-358-8614	78
S2694	W01-358-9203	57
S2734	W01-358-6801	107
S27341	W01-358-8774	90
S2827	W01-358-9010	41
S2883	W01-358-7403	110
S28929	W01-358-9978	44
S2924	W01-358-9227	48
S29892	W01-358-8539	80
S29928	W01-358-9978	44
S3184	W01-358-7140	106
S3411	W01-358-9228	Call us
S3467	W01-358-8792	85
S3467	W01-358-9122	85
S3518	W01-358-6905	100
S3648	W01-358-9215	81
S3798	W01-358-7446	112
S3830	W01-358-9122	85
S3839	W01-358-9200	80
S3842	W01-358-9240	58
S4041	W01-358-9082	46
S4375	W01-358-9367	60
S4771	W01-358-8050	91
S4773	W01-358-9392	49
S5060	W01-358-9238	58
S5270	W01-358-6905	100
S5468	W01-358-7404	110
S6195	W01-358-9192	57
S6242	W01-358-7447	112

PRIMARY TRUCK & TRAILER, AUXILIARY / TAG AXLE
MANUFACTURER TO FIRESTONE NUMBER

MANUFACTURER/ PART NO.	FIRESTONE ASSEMBLY ORDER NO.	PAGE NO.
S6412	W01-358-6803	107
S6861	W01-358-7839	125
S7100	W01-358-7843	125
S7128	W01-358-9156	85
S7193	W01-358-9073	29
S7364	W01-358-9285	30
S7853	W01-358-7846	125
S8701	W01-358-6947	105
S8768	W01-358-6910	100
S8832	W01-358-5310	12
S8874	W01-358-7847	125
S8988	W01-358-9349	Call us
S9346	W01-358-5405	13
S9830	W01-358-7444	112
XDB1561	W01-358-9083	46
Y505801	W01-M58-6339	86
Y505859	W01-M58-6339	86
Y506201	W01-M58-8775	88
Y506243	W01-M58-8775	88
Y50624301	W01-M58-8775	88
HISTEER		
10300	W01-358-7839	125
10301	W01-358-7850	126
10302	W01-358-6941	101
10303	W01-358-8039	127
10305	W01-358-6940	101
10307	W01-358-6944	104
10313	W01-358-8038	127
10315	W01-358-7550	117
10316	W01-358-7557	117
HUTCHENS		
1914101	W01-358-5766	65
H1038401	W01-358-7405	110
H19131	W01-358-9059	42
H2007	W01-358-9075	
H936001	W01-358-9082	46
H942401	W01-358-9039	34
H963001	W01-358-9082	46

MANUFACTURER/ PART NO.	FIRESTONE ASSEMBLY ORDER NO.	PAGE NO.
INGERSOLL RAND		
59302786	W01-358-6910	100
IVECO		
504035755	W01-358-5343	13
JET CO.		
	W01-358-9260	64
JOHN DEERE		
AH160823	W01-358-5336	15
AN205362	W01-358-8931	37
AN205761	W01-M58-8798	89
AW30683	W01-358-6831	118
AW34652	W01-358-6831	118
KASSBOHRER		
4731033000	W01-M58-6339	86
KENWORTH		
C811003	W01-358-8813	41
C811004	W01-358-9547	25
C811005	W01-358-9541	26
K-303-15	W01-358-9422	19
K-303-18	W01-358-9617	25
K-303-22	W01-358-9622	26
K-303-25	W01-358-9625	26
K-303-28	W01-358-9675	26
K-303-5	W01-358-9415	24
K102A	W01-358-9073	29
K30314	W01-358-9422	19
K30315	W01-358-9422	19
K30316	W01-358-9616	20
K30318	W01-358-9617	25
K30319	W01-358-9618	26
K30319	W01-358-9622	26
K30322	W01-358-9622	26
K30323	W01-358-9625	26
K30325	W01-358-9625	26
K30325	W01-358-9625	26
K30328	W01-358-9675	26
K3035	W01-358-9415	24
K3036	W01-358-9422	19

PRIMARY TRUCK & TRAILER, AUXILIARY /TAG AXLE

MANUFACTURER TO FIRESTONE NUMBER

MANUFACTURER/ PART NO.	FIRESTONE ASSEMBLY ORDER NO.	PAGE NO.
KNOEDLER		
9212	W02-358-7010	133
KWIC LOCK		
53671	W01-358-7123	105
CP5125	W01-358-9082	46
CP5223	W01-358-7429	111
LEYLAND		
SC2010	W01-358-6902	99
SC2011	W01-358-6910	100
SC2012	W01-358-7112	98
SC2013	W01-358-7135	106
SC2014	W01-358-7136	106
SC2015	W01-358-7140	106
SC2016	W01-358-7145	106
SC2017	W01-358-7146	106
SC2018	W01-358-7181	108
SC2019	W01-358-7183	109
SC2020	W01-358-7400	109
SC2021	W01-358-7403	110
SC2022	W01-358-7404	110
SC2023	W01-358-7410	111
SC2024	W01-358-7424	111
SC2025	W01-358-7437	111
SC2026	W01-358-7443	112
SC2027	W01-358-7446	112
SC2028	W01-358-7447	112
SC2029	W01-358-7798	123
SC2030	W01-358-7800	123
SC2030	W01-358-7848	126
SC2031	W01-358-7808	124
SC2032	W01-358-7818	124
SC2032	W01-358-7839	125
SC2033	W01-358-9039	34
SC2034	W01-358-9069	42
SC2035	W01-358-9082	46
SC2036	W01-358-9083	46
SC2038	W01-358-9101	57
SC2039	W01-358-9105	38
SC2040	W01-358-9121	82

MANUFACTURER/ PART NO.	FIRESTONE ASSEMBLY ORDER NO.	PAGE NO.
SC2041	W01-358-9122	85
SC2042	W01-358-9148	83
SC2043	W01-358-9149	83
SC2044	W01-358-9156	85
SC2045	W01-358-9158	86
SC2046	W01-358-9177	83
SC2047	W01-358-9215	81
SC2048	W01-358-9213	48
SC2050	W01-358-9422	19
SC2051	W01-358-9096	47
SC2052	W01-358-8050	91
SC2070	W01-358-9219	48
SC2071	W01-358-6905	100
SC2072	W01-358-6927	104
SC2073	W01-358-7405	110
SC2074	W01-358-7409	110
SC2075	W01-358-7180	108
SC2076	W01-358-7406	Call us
SC2077	W01-358-7429	111
SC2078	W01-358-7473	112
SC2079	W01-358-6801	107
SC2080	W01-358-7123	105
SC2098	W01-358-9122	85
SC2102	W01-358-9192	57
SC2108	W01-358-9241	58
SC2109	W01-358-9238	58
SC2110	W01-358-9379	27
SC2116	W01-358-9200	80
SC2119	W01-358-8010	120
SC2120	W01-358-9321	60
SC2121	W01-358-8052	91
SC2122	W01-358-6943	104
SC2123	W01-358-6948	105
SC2124	W01-358-6944	104
SC2125	W01-358-6945	104
SC2126	W01-358-6946	104
SC2127	W01-358-6947	105
SC2129	W01-358-6803	107
SC2130	W01-358-8008	120

PRIMARY TRUCK & TRAILER, AUXILIARY / TAG AXLE
MANUFACTURER TO FIRESTONE NUMBER

MANUFACTURER/ PART NO.	FIRESTONE ASSEMBLY ORDER NO.	PAGE NO.
SC2131	W01-358-8018	121
SC2132	W01-358-8006	120
SC2134	W01-358-9203	57
SC2135	W01-358-7843	125
SC2136	W01-358-7847	125
SC2457	W01-358-9053	38
SC2464	W01-358-9130	57
LINK		
(see 5789)	W01-358-5772	66
11020020	W02-358-7002	131
11020023	W02-358-7001	131
11030019	W01-358-6884	99
11030056	W01-358-7996	120
11030058	W01-358-8842	55
11030059	W01-358-5900	103
11030500	W01-358-5439	16
11030501	W01-358-9562	22
11030503	W01-358-5789	67
11030510	W01-358-8492	29
1102K023	W02-358-7001	131
R811001	W02-358-7001	131
LOAD AIR		
P10755C	W01-358-7344	109
P10794	W01-358-7057	119
P10872A	W01-358-6949	101
P60733	W01-358-9221	83
MACK		
227QS32	W01-358-7325	113
364QS27	W01-358-9375	54
364QS28	W01-358-9466	49
57QK1113	W01-358-7325	113
57QL1115	W01-358-9652	31
57QL239	W01-358-7145	106
57QL310	W01-358-9082	46
57QL411M	W01-358-9466	49
57QL414M	W01-358-9375	54
57QL417M	W01-358-9647	54
57QL46	W01-358-7135	106
57QL53M	W01-M58-9656	55
57QL57M	W01-358-9663	55

MANUFACTURER/ PART NO.	FIRESTONE ASSEMBLY ORDER NO.	PAGE NO.
MASA		
227002002	W01-358-7400	109
227138412	W01-358-6900	99
K27137295	W01-358-9105	38
T27129063	W01-358-9010	41
MAURICE WELDING		
	W01-358-7852	122
	W01-358-7927	115
MCI		
393902468	W01-358-5770	66
MCMMASTER-CARR		
9538K62	W02-358-7002	131
9551K64	W01-358-7845	125
9551K82	W01-358-7180	108
MERITOR		
8619	W01-358-9376	20
200041	W01-358-9241	58
200042	W01-358-6902	99
200117	W01-358-8027	121
200118	W01-358-6944	104
200154	W01-358-9105	38
200175	W01-358-7088	Call us
200177	W01-358-7850	126
200180	W01-358-6946	104
200182	W01-358-9251	Call us
200183	W01-358-6949	101
200448	W01-358-7403	110
200457	W01-358-9039	34
200458	W01-358-9200	80
200504	W01-358-5503	86
200620	W01-358-8006	120
200793	W01-358-5311	12
200981	W01-358-7405	110
201150	W01-358-9249	68
201222	W01-358-9218	81
201293	W01-358-7043	97
201339	W01-358-7446	112
201364	W01-358-7446	112
201377	W01-358-6801	107

PRIMARY TRUCK & TRAILER, AUXILIARY /TAG AXLE

MANUFACTURER TO FIRESTONE NUMBER

MANUFACTURER/ PART NO.	FIRESTONE ASSEMBLY ORDER NO.	PAGE NO.
201498	W01-358-7848	126
201548	W01-358-6935	101
201602	W01-358-7499	Call us
201680	W01-358-8050	91
201847	W01-358-7794	Call us
201869	W01-358-9082	46
202035	W01-358-9192	57
202219	W01-358-9093	47
202263	W01-358-9928	88
202394	W01-358-8018	121
202796	W01-358-8617	79
202796	W01-358-8729	76
203022	W01-358-7843	125
17204517	W01-M58-8775	88
21208082	W01-M58-8775	88
21208939	W01-358-9039	34
21215632	W01-M58-8775	88
21215633	W01-M58-6339	86
21216135	W01-358-9039	34
21222442	W01-M58-7074	62
21227742	W01-358-6231	62
21227742	W01-358-6262	62
21227892	W01-358-6258	71
22581451	W01-358-9459	22
000L21223269	W01-358-9391	24
21227742 FS25	W01-358-6262	62
21227742FS25	W01-358-6231	62
21227892 FS25	W01-358-6258	71
2258A1483	W01-358-8878	37
2258C1459	W01-358-8203	36
2258G1489	W01-358-6392	103
2258J1466	W01-358-9553	Call us
2258N1470	W01-358-9249	68
2258P1576	W01-358-8091	89
2258U1451	W01-358-9459	22
A-2258-C-1459	W01-358-8203	36
A-2258-U-1451	W01-358-9459	22
A22581451	W01-358-9459	22
A2258A1457	W01-358-8171	107

MANUFACTURER/ PART NO.	FIRESTONE ASSEMBLY ORDER NO.	PAGE NO.
A2258A1483	W01-358-8878	37
A2258C1459	W01-358-8203	36
A2258E1461	W01-358-8617	79
A2258F1410	W01-358-8729	76
A2258G1489	W01-358-6392	103
A2258J1466	W01-358-9553	Call us
A2258N1470	W01-358-9249	68
A2258P1576	W01-358-8091	89
MONACO COACH		
8618	W01-358-5319	18
8619	W01-358-9376	20
14002	W01-358-9376	20
1804591	W01-358-8897	20
1806160	W01-358-9651	65
NATIONAL SEATING		
2112283	W02-358-7050	Call us
2123403	W02-358-7001	131
2123403	W02-358-7002	131
NAVISTAR		
1622372C1	W01-358-9287	53
1660581C1	W01-358-9213	48
1660694C1	W01-358-9379	27
1670043C1	W01-358-9371	53
1670073C1	W01-358-9371	53
1672401C1	W01-358-9566	27
1675495C1	W01-358-9568	28
1681579C1	W01-358-9241	58
1681737C1	W01-358-9238	58
1681738C1	W01-358-9192	57
1681739C1	W01-358-9219	48
1681740C1	W01-358-9192	57
1681741C1	W01-358-9149	83
1681742C1	W01-358-9156	85
1681743C1	W01-358-9148	83
1681745C1	W01-358-9158	86
1681746C1	W01-358-9200	80
1681747C1	W01-358-8052	91
1681748C1	W01-358-9144	82
1681749C1	W01-358-9122	85

PRIMARY TRUCK & TRAILER, AUXILIARY / TAG AXLE
MANUFACTURER TO FIRESTONE NUMBER

MANUFACTURER/ PART NO.	FIRESTONE ASSEMBLY ORDER NO.	PAGE NO.
1681750C1	W01-358-7423	111
1681751C1	W01-358-7472	116
1685174C1	W01-358-8050	91
1685175C1	W01-358-6905	100
1685177C1	W01-358-7405	110
1685178C1	W01-358-7409	110
1685179C1	W01-358-7180	108
1685180C1	W01-358-7406	Call us
1685181C1	W01-358-7429	111
1685182C1	W01-358-7473	112
1685183C1	W01-358-6801	107
1685184C1	W01-358-7123	105
1686386C1	W01-358-9371	53
1R12523	W01-358-1190	73
2027911C1	W01-358-9371	53
2027911C1	W01-358-9648	73
2027911C2	W01-358-9648	73
2027911C3	W01-358-9648	73
2027912C1	W01-358-9565	27
2027913C1	W01-358-9567	27
2027913C1	W01-358-9568	28
202791C1	W01-358-9566	27
3541731C1	W01-358-1191	73
3541732C1	W01-358-1190	73
3541732C1	W01-358-1190	73
3691773C1	W01-358-1192	73
501559C1	W01-358-9213	48
501559C2	W01-358-9213	48
517096C91	W01-358-9092	46
517559C9	W01-358-9082	46
554761C1	W01-358-9415	24
554762C1	W01-358-9422	19
554763C1	W01-358-9083	46
554764C1	W01-358-9069	42
554766C1	W01-358-9039	34
554770C1	W01-358-9105	38
554771C1	W01-358-9096	47
554772C1	W01-358-9122	85

MANUFACTURER/ PART NO.	FIRESTONE ASSEMBLY ORDER NO.	PAGE NO.
554773C1	W01-358-9121	82
554776C1	W01-358-9149	83
554777C1	W01-358-9156	85
554778C1	W01-358-9148	83
554779C1	W01-358-9177	83
554780C1	W01-358-9158	86
554781C1	W01-358-9215	81
554782C1	W01-358-7112	98
554783C1	W01-358-6910	100
554784C1	W01-358-6902	99
554785C1	W01-358-7424	111
554786C1	W01-358-7443	112
554787C1	W01-358-7403	110
554788C1	W01-358-7400	109
554789C1	W01-358-7401	109
554789C1	W01-358-7437	111
554790C1	W01-358-7447	112
554791C1	W01-358-7446	112
554792C1	W01-358-7410	111
554793C1	W01-358-7404	110
554794C1	W01-358-7181	108
554795C1	W01-358-7183	109
554796C1	W01-358-7145	106
554797C1	W01-358-7146	106
554798C1	W01-358-7136	106
554799C1	W01-358-7140	106
554800C1	W01-358-7135	106
554801C1	W01-358-7808	124
NEOPLAN		
BJ1003010	W01-358-9280	83
KH1003010	W01-358-8980	82
MD1003009	W01-358-9105	38
NEW FLYER		
5920815	W01-358-5406	13
NEWLITE		
NS19016	W01-358-8204	36

PRIMARY TRUCK & TRAILER, AUXILIARY /TAG AXLE

MANUFACTURER TO FIRESTONE NUMBER

MANUFACTURER/ PART NO.	FIRESTONE ASSEMBLY ORDER NO.	PAGE NO.
NOVABUS		
G1012381	W01-358-9017	29
G1019358	W01-358-9017	29
G1019449	W01-358-9017	29
G1019450	W01-358-9017	29
G1020957	W01-358-9017	29
G5001705	W01-358-5730	16
G5001706	W01-358-9017	29
N15558	W01-358-9017	29
N16374	W01-358-9441	24
N17842	W01-358-8828	62
NUMATICS		
ASND3161	W01-358-6900	99
ASND8271	W01-358-9529	108
ASNS5131	W01-358-7011	97
ORION		
10132404	W01-358-9306	35
50232501	W01-358-8970	35
101324014	W01-358-9039	34
OSHKOSH		
8013	W01-358-8010	120
3620210	W01-358-8781	84
RX0803	W01-358-9269	Call us
OTTAWA		
7131503	W01-358-8616	77
50232501	W01-358-8970	35
53500516	W01-358-7304	124
PACCAR		
C811011	W01-358-8864	56
C811012	W01-358-8813	41
C811013	W01-358-8864	56
PEERLESS		
5500051	W01-358-9031	34
55000001	W01-358-7180	108
55000010	W01-358-9149	83
55000015	W01-358-7103	97
55000030	W01-358-7808	124
55000051	W01-358-9031	34
55000070	W01-358-9148	83
55000080	W01-358-9156	85

MANUFACTURER/ PART NO.	FIRESTONE ASSEMBLY ORDER NO.	PAGE NO.
PEGASO		
175005	W01-M58-6339	86
PETERBILT		
301649	W01-358-9069	42
301686	W01-358-8478	29
302038	W01-358-9069	42
302456	W01-358-9069	42
304759	W01-358-9069	42
305107	W01-358-9194	47
306213	W01-358-9026	46
306746	W01-358-9069	42
307111	W01-358-9026	46
307112	W01-358-9069	42
0307887	W01-358-8852	56
308424	W01-358-8478	29
308716	W01-358-8864	56
310042	W01-358-9069	42
C816000	W01-358-8813	41
C816022	W01-358-9069	42
PIONEER		
	W01-358-9071	42
PIRELLI		
93029	W01-358-7001	96
94016	W01-358-7008	96
PREVOST		
630044	W01-358-9380	Call us
630045	W01-358-9073	29
630158	W01-358-9017	29
630173	W01-358-6900	99
630174	W01-358-6910	100
630194	W01-358-9017	29
630226	W01-358-5730	16
RENAULT		
Midlum 250 Truck	W01-M58-8712	78
REXROTH-MECMAN		
299-934-000-0	W01-358-3400	116
299-969-000-0	W01-358-6910	100
299-970-010-0	W01-358-7001	96
299-970-110-0	W01-358-7008	96
299-970-250-0	W01-358-7025	119

PRIMARY TRUCK & TRAILER, AUXILIARY / TAG AXLE
MANUFACTURER TO FIRESTONE NUMBER

MANUFACTURER/ PART NO.	FIRESTONE ASSEMBLY ORDER NO.	PAGE NO.
299-971-010-0	W01-358-7103	97
299-971-430-0	W01-358-7145	106
299-971-840-0	W01-358-7180	108
299-973-010-0	W01-358-7230	115
299-973-040-0	W01-358-7304	124
299-973-200-0	W01-358-7304	124
299-973-270-0	W01-358-7325	113
299-974-420-0	W01-358-7444	112
299-975-980-0	W01-358-7598	Call us
299-977-610-0	W01-358-7761	122
299-978-020-0	W01-358-7808	124
299-978-420-0	W01-358-7845	125
299-995-290-0	W01-358-6800	107
REYCO GRANNING		
1014	W01-358-7818	124
1015	W01-358-7140	106
1218	W01-358-7443	112
1359	W01-358-9083	46
1371	W01-358-6910	100
1613	W01-358-7798	123
1626	W01-358-7136	106
1971	W01-358-5406	13
2112	W01-358-5410	14
2279	W01-358-7118	Call us
2303	WC1-358-9452	Call us
2524	W01-358-7286	122
2577	W01-358-9210	47
2598	W01-358-9214	Call us
2692	W01-358-9211	48
2725	W01-358-7403	110
2726	W01-358-7400	109
2727	W01-358-9342	50
4848	W01-358-6902	99
5065	W01-358-9105	38
5122	W01-358-2119	12
5235	W01-358-5423	14
5301	W01-358-8977	16
5307	W01-358-5423	14
5385	W01-358-8922	23
5492	W01-358-8922	23

MANUFACTURER/ PART NO.	FIRESTONE ASSEMBLY ORDER NO.	PAGE NO.
5553	W01-358-8979	17
5691	W01-358-2120	12
6057	W01-358-8965	Call us
6104	W01-358-2120	12
6117	W01-358-5426	17
6250	W01-358-9478	15
6252	W01-358-9049	29
6352	W01-358-6943	104
6389	W01-358-6905	100
6390	W01-358-6944	104
6391	W01-358-7446	112
6392	W01-358-8008	120
6393	W01-358-8018	121
6394	W01-358-9122	85
6396	W01-358-9245	58
6418	W01-358-9082	46
6419	W01-358-7112	98
6420	W01-358-7135	106
6421	W01-358-7424	111
6422	W01-358-7437	111
6424	W01-358-9121	82
6425	W01-358-9158	86
6426	W01-358-9177	83
6427	W01-358-9250	70
6428	W01-358-9275	69
6429	W01-358-9421	66
6941	W01-358-9101	57
7025	W01-358-6960	105
7026	W01-358-7855	Call us
7504	W01-358-5323	13
7593	W01-358-8760	80
7692	W01-358-8918	Call us
7765	W01-358-5434	15
7831	W01-358-5436	Call us
7901	W01-358-8735	79
8221	W01-358-7996	120
8273	W01-358-9825	90
8452	W01-358-9947	52
8609	W01-358-5702	17
1288201	W01-358-9082	46

PRIMARY TRUCK & TRAILER, AUXILIARY / TAG AXLE

MANUFACTURER TO FIRESTONE NUMBER

MANUFACTURER/ PART NO.	FIRESTONE ASSEMBLY ORDER NO.	PAGE NO.
1288202	W01-358-9121	82
1288301	W01-358-9101	57
1288302	W01-358-9122	85
1288401	W01-358-9223	48
1290601	W01-358-6927	104
1292801	W01-358-9010	41
1736001	W01-358-9308	34
1736101	W01-358-8900	Call us
1741401	W01-358-8991	37
1763601	W01-358-9349	Call us
1881301	W01-358-7555	117
1998301	W01-358-7557	117
2001801	W01-358-7555	117
2007401	W01-358-9332	Call us
2012401	W01-358-9966	50
2012402	W01-358-9966	50
2012412	W01-358-9966	50
2014201	W01-358-9947	52
2043701	W01-358-9333	35
2077200	W01-358-5775	66
2077301	W01-358-8959	28
2078301	W01-358-5775	66
2096601	W01-358-9474	50
2105401	W01-358-9377	Call us
2105501	W01-358-8976	Call us
2159801	W01-358-8964	33
2176701	W01-358-8776	Call us
2224101	W01-358-8932	37
2242501	W01-358-5777	67
2274701	W01-358-8720	75
2283601	W01-358-9691	Call us
2337701	W01-358-8961	33
2343301	W01-358-8740	74
2352101	W01-358-8855	56
2352102	W01-358-8856	56
2363101	W01-358-8050	91
2452001	W01-358-9320	59
2489401	W01-358-9690	Call us
2539601	W01-358-9560	25
2543701	W01-358-9559	Call us

MANUFACTURER/ PART NO.	FIRESTONE ASSEMBLY ORDER NO.	PAGE NO.
7059511	W01-358-8636	Call us
70002901	W01-358-8735	79
70019501	W01-358-8735	79
70099901	W01-358-8733	Call us
70131503	W01-358-8616	77
70178401	W01-358-6886	103
70261401	W01-358-8824	45
70293201	W01-358-6856	98
70418501	W01-358-7897	103
70467102	W01-358-8855	56
1284401B	W01-358-9944	Call us
1288401A	W01-358-9223	48
1288401B	W01-358-9944	Call us
2012401A	W01-358-9966	50
2014201K	W01-358-9947	52
700136-01	W01-358-9825	90
93AR	W01-358-8018	121
RIDEWELL		
1000003	W01-358-1096	45
1003587330	W01-358-7330	113
1003588919	W01-358-8919	23
1001R13109G	W01-358-8782	75
1003535770C	W01-358-5770	66
1003582119C	W01-358-2119	12
1003582131C	W01-358-2131	12
1003585310C	W01-358-5310	12
1003585311C	W01-358-5311	12
1003585323C	W01-358-5323	13
1003585410C	W01-358-5410	14
1003585412C	W01-358-5412	14
1003585414C	W01-358-5414	14
1003585770C	W01-358-5770	66
1003585792C	W01-358-5792	67
1003586801C	W01-358-6801	107
1003586805C	W01-358-6805	108
1003586817C	W01-358-6817	103
1003586897C	W01-358-6897	99
1003586900C	W01-358-6900	99
1003586902C	W01-358-6902	99
1003586905C	W01-358-6905	100

PRIMARY TRUCK & TRAILER, AUXILIARY / TAG AXLE
MANUFACTURER TO FIRESTONE NUMBER

MANUFACTURER/ PART NO.	FIRESTONE ASSEMBLY ORDER NO.	PAGE NO.
1003586908C	W01-358-6908	100
1003586910C	W01-358-6910	100
1003586932C	W01-358-6932	100
1003586943C	W01-358-6943	104
1003586945C	W01-358-6945	104
1003586946C	W01-358-6946	104
1003586947C	W01-358-6947	105
1003586948C	W01-358-6948	105
1003587009C	W01-358-7009	96
1003587103C	W01-358-7103	97
1003587104C	W01-358-7104	97
1003587112C	W01-358-7112	98
1003587123C	W01-358-7123	105
1003587135C	W01-358-7135	106
1003587136C	W01-358-7136	106
1003587140C	W01-358-7140	106
1003587145C	W01-358-7145	106
1003587146C	W01-358-7146	106
1003587180C	W01-358-7180	108
1003587181C	W01-358-7181	108
1003587183C	W01-358-7183	109
1003587271C	W01-358-7271	114
1003587273C	W01-358-7273	115
1003587274C	W01-358-7274	124
1003587275C	W01-358-7275	115
1003587286C	W01-358-7286	122
1003587304C	W01-358-7304	124
1003587325C	W01-358-7325	113
1003587330C	W01-358-7330	113
1003587400C	W01-358-7400	109
1003587403C	W01-358-7403	110
1003587404C	W01-358-7404	110
1003587406C	W01-358-7406	Call us
1003587410C	W01-358-7410	111
1003587424C	W01-358-7424	111
1003587429C	W01-358-7429	111
1003587437C	W01-358-7437	111
1003587443C	W01-358-7443	112
1003587444C	W01-358-7444	112
1003587446C	W01-358-7446	112

MANUFACTURER/ PART NO.	FIRESTONE ASSEMBLY ORDER NO.	PAGE NO.
1003587447C	W01-358-7447	112
1003587473C	W01-358-7473	112
1003587483C	W01-358-7483	Call us
1003587761C	W01-358-7761	122
1003587781C	W01-358-7781	118
1003587796C	W01-358-7796	123
1003587798C	W01-358-7798	123
1003587800C	W01-358-7800	123
1003587808C	W01-358-7808	124
1003587818C	W01-358-7818	124
1003587839C	W01-358-7839	125
1003587843C	W01-358-7843	125
1003587844C	W01-358-7844	Call us
1003587846C	W01-358-7846	125
1003587892C	W01-358-7892	102
1003587893C	W01-358-7892	102
1003588008C	W01-358-8008	120
1003588010C	W01-358-8010	120
1003588014C	W01-358-8014	120
1003588016C	W01-358-8016	121
1003588018C	W01-358-8018	121
1003588030C	W01-358-8030	121
1003588032C	W01-358-8032	122
1003588050C	W01-358-8050	91
1003588051C	W01-358-8051	Call us
1003588052C	W01-358-8052	91
1003588088C	W01-358-8088	Call us
1003588201C	W01-358-8201	Call us
1003588752C	W01-358-8752	74
1003588753C	W01-358-8753	74
1003588778C	W01-358-8778	81
1003588782C	W01-358-8782	75
1003588802C	W01-358-8802	40
1003588803C	W01-358-8803	40
1003588805C	W01-358-8805	40
1003588806C	W01-358-8806	40
1003588901C	W01-358-8901	20
1003588919C	W01-358-8919	23
1003588924C	W01-358-8924	45
1003588930C	W01-358-8930	Call us

PRIMARY TRUCK & TRAILER, AUXILIARY /TAG AXLE

MANUFACTURER TO FIRESTONE NUMBER

MANUFACTURER/ PART NO.	FIRESTONE ASSEMBLY ORDER NO.	PAGE NO.
1003588963C	W01-358-8963	33
1003588986C	W01-358-8986	Call us
1003588991C	W01-358-8991	37
1003588992C	W01-358-8992	19
1003588997C	W01-358-8997	19
1003588997C1	W01-358-8997	19
1003589008C	W01-358-9008	Call us
1003589010C	W01-358-9010	41
1003589029C	W01-358-9029	Call us
1003589031C	W01-358-9031	34
1003589033C	W01-358-9033	34
1003589039C	W01-358-9039	34
1003589053C	W01-358-9053	38
1003589059C	W01-358-9059	42
1003589069C	W01-358-9069	42
1003589070C	W01-358-9070	42
1003589071C	W01-358-9071	42
1003589073C	W01-358-9073	29
1003589075C	W01-358-9075	Call us
1003589077C	W01-358-9077	Call us
1003589078C	W01-358-9078	38
1003589082C	W01-358-9082	46
1003589083C	W01-358-9083	46
1003589096C	W01-358-9096	47
1003589101C	W01-358-9101	57
1003589105C	W01-358-9105	38
1003589118C	W01-358-9118	38
1003589121C	W01-358-9121	82
1003589122C	W01-358-9122	85
1003589149C	W01-358-9149	83
1003589158C	W01-358-9158	86
1003589177C	W01-358-9177	83
1003589192C	W01-358-9192	57
1003589200C	W01-358-9200	80
1003589203C	W01-358-9203	57
1003589213C	W01-358-9213	48
1003589218C	W01-358-9218	81
1003589219C	W01-358-9219	48
1003589223C	W01-358-9223	48

MANUFACTURER/ PART NO.	FIRESTONE ASSEMBLY ORDER NO.	PAGE NO.
1003589245C	W01-358-9245	58
1003589250C	W01-358-9250	70
1003589251C	W01-358-9251	Call us
1003589270C	W01-358-9270	71
1003589274C	W01-358-9274	68
1003589275C	W01-358-9275	69
1003589290C	W01-358-9290	30
1003589308C	W01-358-9308	34
1003589320C	W01-358-9320	59
1003589321C	W01-358-9321	60
1003589334C	W01-358-9334	35
1003589368C	W01-358-9368	60
1003589370C	W01-358-9370	60
1003589378C	W01-358-9378	Call us
1003589387C	W01-358-9387	21
1003589394C	W01-358-9394	59
1003589415C	W01-358-9415	24
1003589421C	W01-358-9421	66
1003589422C	W01-358-9422	19
1003589423C	W01-358-9423	66
1003589445C	W01-358-9445	21
1003589447C	W01-358-9447	21
1003589448C	W01-358-9448	21
1003589457C	W01-358-9457	21
1003589459C	W01-358-9459	22
1003589459C1	W01-358-9459	22
1003589467C	W01-358-9467	43
1003589477C	W01-358-9477	22
1003589538C	W01-358-9538	Call us
1003589595C	W01-358-9595	31
1003589780C	W01-358-9780	72
1003589797C	W01-358-9797	44
1003589961C	W01-358-9961	Call us
1003599083C	W01-358-9083	46
101015P453	W01-358-8709	78
101015S453	W01-358-8709	78
101015S518	W01-358-8752	74
101015S522	W01-358-8755	75
101015S711	W01-358-8710	79

PRIMARY TRUCK & TRAILER, AUXILIARY / TAG AXLE
MANUFACTURER TO FIRESTONE NUMBER

MANUFACTURER/ PART NO.	FIRESTONE ASSEMBLY ORDER NO.	PAGE NO.
101015S713	W01-358-8753	74
101015S773	W01-358-8740	74
101015s871	W01-358-8782	75
101016S526	W01-358-8708	78
101016S533	W01-358-8713	78
101021P434	W01-358-9580	79
101021P486	W01-358-8749	76
101021P570	W01-358-8748	76
10105av12p513	W01-358-8729	76
10105BV16P273	W01-358-8539	80
10105P460	W01-358-8709	78
1010B13S513	W01-358-8729	76
1013589039C	W01-358-9039	34
S2061C	W01-358-9039	34
S3081C	W01-358-8992	19
ROR		
21222442	W01-M58-7074	62
ROWETRUCK		
0027ASC2500	W01-358-8888	50
0035ASC1600	W01-358-7686	101
0035ASC2500	W01-358-7686	101
0059ASC1500	W01-358-7956	127
0266ASC1600HL	W01-358-9811	84
RR LOAD		
LS150	W01-358-7462	98
LS20	W01-358-6926	100
RSTRUCK		
1027405	W01-358-6910	100
1027505	W01-358-6902	99
1027519	W01-358-7400	109
1027556	W01-358-7136	106
1040201	W01-358-7403	110
1082914	W01-358-7446	112
1090023	W01-358-9121	82
1090214	W01-358-7140	106
1090215	W01-358-7424	111
1090216	W01-358-9177	83
1090217	W01-358-9082	46
1090218	W01-358-9039	34

MANUFACTURER/ PART NO.	FIRESTONE ASSEMBLY ORDER NO.	PAGE NO.
SAF HOLLAND		
6764	W01-358-7304	124
6788	W01-358-7230	115
8454	W01-358-9936	52
50857000	W01-358-9807	39
57005410	W01-358-5410	14
57006801	W01-358-6801	107
57006803	W01-358-6803	107
57006902	W01-358-6902	99
57006905	W01-358-6905	100
57006910	W01-358-6910	100
57006927	W01-358-6927	104
57006941	W01-358-6941	101
57006947	W01-358-6947	105
57007123	W01-358-7123	105
57007136	W01-358-7136	106
57007140	W01-358-7140	106
57007145	W01-358-7145	106
57007180	W01-358-7180	108
57007181	W01-358-7181	108
57007183	W01-358-7183	109
57007325	W01-358-7325	113
57007401	W01-358-7401	109
57007403	W01-358-7403	110
57007404	W01-358-7404	110
57007405	W01-358-7405	110
57007406	W01-358-7406	Call us
57007409	W01-358-7409	110
57007410	W01-358-7410	111
57007429	W01-358-7429	111
57007443	W01-358-7443	112
57007446	W01-358-7446	112
57007447	W01-358-7447	112
57007472	W01-358-7472	116
57007473	W01-358-7473	112
57007798	W01-358-7798	123
57007800	W01-358-7800	123
57007808	W01-358-7808	124
57007818	W01-358-7818	124

PRIMARY TRUCK & TRAILER, AUXILIARY /TAG AXLE

MANUFACTURER TO FIRESTONE NUMBER

MANUFACTURER/ PART NO.	FIRESTONE ASSEMBLY ORDER NO.	PAGE NO.
57007839	W01-358-7839	125
57008008	W01-358-8008	120
57008050	W01-358-8050	91
57008052	W01-358-8052	91
57009053	W01-358-9053	38
57009069	W01-358-9069	42
57009073	W01-358-9073	29
57009077	W01-358-9077	Call us
57009078	W01-358-9078	38
57009083	W01-358-9083	46
57009096	W01-358-9096	47
57009105	W01-358-9105	38
57009130	W01-358-9130	57
57009149	W01-358-9149	83
57009194	W01-358-9194	47
57009200	W01-358-9200	80
57009210	W01-358-9210	47
57009213	W01-358-9213	48
57009215	W01-358-9215	81
57009219	W01-358-9219	48
57009223	W01-358-9223	48
57009238	W01-358-9238	58
57009250	W01-358-9250	70
57009275	W01-358-9275	69
57009302	W01-358-9302	Call us
57009321	W01-358-9321	60
57009379	W01-358-9379	27
57009415	W01-358-9415	24
57009421	W01-358-9421	66
57009422	W01-358-9422	19
90023493	WC1-358-0528	Call us
90023494	WC1-358-1634	Call us
90023495	WC1-358-9453	Call us
90023496	WC1-358-9452	Call us
90044197	W01-358-9158	86
90044199	W01-358-9039	34
90044200	W01-358-9082	46
90044201	W01-358-9101	57
90044216	W01-358-9082	46
90044647	W01-358-9082	46

MANUFACTURER/ PART NO.	FIRESTONE ASSEMBLY ORDER NO.	PAGE NO.
90044658	W01-358-9122	85
90044701	W01-358-9101	57
90044702	W01-358-9121	82
90045007	WC1-358-0666	Call us
90045008	WC1-358-1619	Call us
90045009	WC1-358-0664	Call us
90045102	WC1-358-1616	Call us
90054043	W01-358-9122	85
90054060	W01-358-9121	82
90054218	W01-358-9101	57
90054234	W01-358-9039	34
90054540	W01-358-9268	63
90057057	W01-358-5412	14
90554043	W01-358-9122	85
90557001	W01-358-7135	106
90557002	W01-358-7009	96
90557003	W01-358-9177	83
90557005	W01-358-9158	86
90557006	W01-358-9082	46
90557007	W01-358-9093	47
90557008	W01-358-9101	57
90557009	W01-358-9101	57
90557010	W01-358-9121	82
90557011	W01-358-9039	34
90557012	W01-358-9033	34
90557014	W01-358-7424	111
90557015	W01-358-7437	111
90557016	W01-358-7400	109
90557018	W01-358-7400	109
90557019	W01-358-9121	82
90557020	W01-358-9122	85
90557023	W01-358-9039	34
90557024	W01-358-7146	106
90557026	W01-358-7112	98
90557027	W01-358-9082	46
90557028	W01-358-7112	98
90557029	W01-358-8997	19
90557030	W01-358-9075	Call us
90557031	W01-358-9092	46
90557032	W01-358-9093	47

PRIMARY TRUCK & TRAILER, AUXILIARY / TAG AXLE
MANUFACTURER TO FIRESTONE NUMBER

MANUFACTURER/ PART NO.	FIRESTONE ASSEMBLY ORDER NO.	PAGE NO.
90557033	W01-358-9082	46
90557034	W01-358-8997	19
90557035	W01-358-9093	47
90557037	W01-358-9082	46
90557038	W01-358-9070	42
90557038	W01-358-9105	38
90557039	W01-358-7146	106
90557043	W01-358-9101	57
90557052	W01-358-9121	82
90557054	W01-358-9082	46
90557069	W01-358-9158	86
90557071	W01-358-9122	85
90557075	W01-358-9082	46
90557076	W01-358-9122	85
90557077	W01-358-9122	85
90557078	W01-358-9121	82
90557082	W01-358-9101	57
90557083	W01-358-9121	82
90557085	W01-358-9039	34
90557086	W01-358-9192	57
90557089	W01-358-9308	34
90557089	W01-358-9314	Call us
90557090	W01-358-9070	42
90557094	W01-358-9599	31
90557097	W01-358-9650	65
90557098	W01-358-8053	91
90557099	W01-358-9320	59
90557101	W01-358-9193	47
90557102	W01-358-5503	86
90557102	W01-358-5511	87
90557103	W01-358-5505	87
90557104	W01-358-9915	88
90557106	W01-358-9929	Call us
90557107	W01-358-9249	68
90557108	W01-358-9192	57
90557109	W01-358-9192	57
90557110	W01-358-9121	82
90557110	W01-358-9141	82
90557111	W01-358-9138	85
90557112	W01-358-9243	58

MANUFACTURER/ PART NO.	FIRESTONE ASSEMBLY ORDER NO.	PAGE NO.
90557113	W01-358-9362	49
90557117	W01-358-9921	51
90557118	W01-358-9923	51
90557119	W01-358-9922	51
90557120	W01-358-9293	32
90557121	W01-358-9295	33
90557122	W01-358-9291	32
90557123	W01-358-9268	63
90557124	W01-358-9304	49
90557125	W01-358-9134	84
90557126	W01-358-9346	59
90557127	W01-358-9294	32
90557129	W01-358-9307	35
90557130	W01-358-9463	Call us
90557131	W01-358-9463	Call us
90557133	W01-358-9896	88
90557134	W01-358-9896	88
90557135	W01-358-9192	57
90557136	W01-358-9192	57
90557138	W01-358-9902	51
90557139	W01-358-9291	32
90557142	W01-358-9942	52
90557143	W01-358-9943	52
90557144	W01-358-9896	88
90557145	W01-358-9470	69
90557146	W01-358-9471	69
90557147	W01-358-9472	69
90557148	W01-358-9896	88
90557149	W01-358-9325	39
90557150	W01-358-8949	32
90557152	W01-358-9473	69
90557155	W01-358-9144	82
90557156	W01-358-9936	52
90557157	W01-358-9935	51
90557158	W01-358-9484	43
90557159	W01-358-9365	39
90557160	W01-358-9366	39
90557161	W01-358-9482	43
90557162	W01-358-8780	84
90557163	W01-358-8779	84

PRIMARY TRUCK & TRAILER, AUXILIARY /TAG AXLE

MANUFACTURER TO FIRESTONE NUMBER

MANUFACTURER/ PART NO.	FIRESTONE ASSEMBLY ORDER NO.	PAGE NO.
90557164	W01-358-8778	81
90557167	W01-358-8748	76
90557168	W01-358-8749	76
90557169	W01-358-8903	63
90557170	W01-358-8802	40
90557172	W01-358-9597	31
90557173	W01-358-8201	Call us
90557173	W01-358-8204	36
90557174	W01-358-5776	67
90557177	W01-358-9471	69
90557178	W01-358-9472	69
90557179	W01-358-9473	69
90557181	W01-358-9472	69
90557182	W01-358-9471	69
90557184	W01-358-9484	43
90557185	W01-358-9122	85
90557189	W01-358-8803	40
90557194	W01-358-8803	40
90557200	W01-358-5503	86
90557203	W01-358-6799	117
90557205	W01-358-8781	84
90557206	W01-358-9491	70
90557208	W01-358-9496	50
90557209	W01-358-9218	81
90557210	W01-358-8203	36
90557210	W01-358-9366	39
90557211	W01-358-9470	69
90557211	W01-358-9502	70
90557212	W01-358-9471	69
90557212	W01-358-9501	70
90557213	W01-358-9472	69
90557213	W01-358-9491	70
90557214	W01-358-9471	69
90557214	W01-358-9501	70
90557215	W01-358-9473	69
90557215	W01-358-9504	70
90557216	W01-358-9473	69
90557216	W01-358-9504	70
90557218	W01-358-9891	87
90557219	W01-358-9585	44

MANUFACTURER/ PART NO.	FIRESTONE ASSEMBLY ORDER NO.	PAGE NO.
90557220	W01-358-9587	30
90557221	W01-358-9586	68
90557223	W01-358-8204	36
90557224	W01-358-9584	20
90557225	W01-358-9366	39
90557226	W01-358-7008	96
90557228	W01-358-6890	99
90557229	W01-358-8198	36
90557230	W01-358-8197	36
90557232	W01-358-9578	68
90557235	W01-358-8746	75
90557236	W01-358-8042	127
90557237	W01-358-6943	104
90557240	W01-358-9582	68
90557241	W01-358-9895	Call us
90557243	W01-358-8744	75
90557247	W01-358-9585	44
90557248	W01-358-9587	30
90557249	W01-358-9586	68
90557250	W01-358-9584	20
90557252	W01-358-9649	54
90557256	W01-358-8195	36
90557260	W01-358-8764	Call us
90557270	W01-358-8793	90
90557271	W01-358-8738	77
90557272	W01-358-8737	77
90557275	W01-358-9507	44
90557283	W01-358-8796	85
90557288	W01-358-8748	76
90557289	W01-358-8749	76
90557290	W01-358-8184	19
90557295	W01-358-9971	52
90557300	W01-358-9936	52
90557301	W01-358-9935	51
90557302	W01-358-9972	Call us
90557308	W01-358-8184	19
90557313	W01-358-9507	44
90557323	W01-358-9144	82
90557329	W01-358-9697	44
90557332	W01-358-9974	53

PRIMARY TRUCK & TRAILER, AUXILIARY / TAG AXLE
MANUFACTURER TO FIRESTONE NUMBER

MANUFACTURER/ PART NO.	FIRESTONE ASSEMBLY ORDER NO.	PAGE NO.
90557354	W01-358-9855	Call us
90557358	W01-358-9502	70
90557363	W01-358-9807	39
90557369	W01-358-9974	53
90557372	W01-358-9807	39
90557434	W01-358-5530	90
322800010	W01-358-9033	34
2229000200	W01-M58-8775	88
2229000300	W01-M58-6339	86
3228000200	W01-M58-8775	88
3228000300	W01-M58-6339	86
3228210300	W01-M58-6339	86
3229000300	W01-M58-6339	86
3229001101	W01-M58-6339	86
3229001800	W01-M58-6339	86
3229003100	W01-M58-6348	89
8403/102	W01-M58-6339	86
90557006G	W01-358-9082	46
90557011G	W01-358-9039	34
90557019G	W01-358-9121	82
90557020G	W01-358-9122	85
90557029G	W01-358-8997	19
90557034G	W01-358-8997	19
90557037G	W01-358-9082	46
90557038G	W01-358-9070	42
90557075T	W01-358-9082	46
90557076T	W01-358-9122	85
90557082T	W01-358-9101	57
90557083T	W01-358-9121	82
90557085T	W01-358-9039	34
90557130RH	W01-358-9463	Call us
90557131LH	W01-358-9463	Call us
AR11151F	W01-358-9177	83
AR12151F	W01-358-9158	86
AR13151F	W01-358-9082	46
AR13151G	W01-358-9082	46
AR13153F	W01-358-9082	46
AR13153G	W01-358-9082	46
AR13154F	W01-358-9093	47
AR13155G	W01-358-9070	42

MANUFACTURER/ PART NO.	FIRESTONE ASSEMBLY ORDER NO.	PAGE NO.
AR14151F	W01-358-9101	57
AR14151G	W01-358-9101	57
AR15151	W01-358-9033	34
AR15171F	W01-358-9039	34
AR15171G	W01-358-9039	34
AR1520M	W01-358-7146	106
AR1834	W01-358-7112	98
AR21A	W01-358-7135	106
AR741	W01-358-7009	96
AR901	W01-358-9070	42
TC1442	W01-358-7424	111
TC1443A	W01-358-7437	111
TC1444	W01-358-7400	109
XDSPN05360	W01-358-8204	36
SAMRO		
2500008	W01-M58-8775	88
2500009	W01-M58-6339	86
SAURER		
P10754	W01-358-7325	113
P10755	W01-358-7423	111
P10755	W01-358-7424	111
P10755C	W01-358-7344	109
P10784	W01-358-7423	111
P10794	W01-358-7057	119
P10872A	W01-358-6949	101
P20706	W01-358-3406	116
P50732	W01-358-9122	85
P50733	W01-358-9121	82
P50734	W01-358-9039	34
P60733	W01-358-9221	83
SCANIA		
412418	W01-358-9105	38
660251	W01-358-9652	31
670199	W01-358-7400	109
SEATS		
200117	W01-358-8027	121
200175	W01-358-7088	Call us
201642	W01-358-8752	74
SEDDON ATKINSON		
3305939	W02-358-7002	131
3305939 R91	W02-358-7002	131

PRIMARY TRUCK & TRAILER, AUXILIARY /TAG AXLE

MANUFACTURER TO FIRESTONE NUMBER

MANUFACTURER/ PART NO.	FIRESTONE ASSEMBLY ORDER NO.	PAGE NO.
SILENT DRIVE		
AS6882	W01-358-6905	100
AS87290	W01-358-8729	76
	W01-358-5429	18
	W01-358-8025	121
SUPERIOR		
	W01-358-7915	123
SUSPENSION DYNAMICS		
55015	W01-358-9249	68
630044	W01-358-9380	Call us
630045	W01-358-9073	29
630158	W01-358-9017	29
630173	W01-358-6900	99
630174	W01-358-6910	100
630194	W01-358-9017	29
630226	W01-358-5730	16
SUSPENSION INC.		
200041	W01-358-9394	59
200042	W01-358-6902	99
200118	W01-358-6944	104
200154	W01-358-9105	38
200177	W01-358-7850	126
200981	W01-358-7405	110
201150	W01-358-9249	68
T.E.C.		
506003	W01-358-9122	85
507505	W01-358-9096	47
505859/01	W01-M58-6339	86
506243/01	W01-M58-8775	88
TERBERG		
21065660	W01-358-7325	113
21067249	W01-358-9401	65
21067978	W01-358-9106	57
TITAN		
91687700000	W01-M58-6339	86
TMC		
6989635	W01-358-9017	29
12TA12	W01-358-9039	34

MANUFACTURER/ PART NO.	FIRESTONE ASSEMBLY ORDER NO.	PAGE NO.
TOYO		
K27102	W01-358-9749	25
TRL200E	W01-358-9421	66
TRL230H36038200	W01-358-9422	19
TRL240393	W01-358-9082	46
TRL250	W01-358-9101	57
TRL270476	W01-358-9122	85
	W02-358-7103	Call us
TRAILERS DE		
73312	W01-358-7185	109
73312B	W01-358-6910	100
TRAILOR		
0036158E	W01-M58-6339	86
650234Y	W01-M58-6339	86
TRUCKSTELL		
63640	W01-358-7808	124
63641	W01-358-7135	106
63644	W01-358-7135	106
63647	W01-358-9101	57
TUTHILL REYCO		
23631-01	W01-358-5523	90
TUTHILL TECHNOLOGY		
1014	W01-358-7818	124
1015	W01-358-7140	106
1218	W01-358-7443	112
1359	W01-358-9083	46
1371	W01-358-6910	100
1613	W01-358-7798	123
1626	W01-358-7136	106
1971	W01-358-5406	13
2112	W01-358-5410	14
2279	W01-358-7118	Call us
2303	WC1-358-9452	Call us
2524	W01-358-7286	122
2577	W01-358-9210	47
2598	W01-358-9214	Call us
2692	W01-358-9211	48
2725	W01-358-7403	110
2726	W01-358-7400	109

PRIMARY TRUCK & TRAILER, AUXILIARY / TAG AXLE
MANUFACTURER TO FIRESTONE NUMBER

MANUFACTURER/ PART NO.	FIRESTONE ASSEMBLY ORDER NO.	PAGE NO.
2727	W01-358-9342	50
4848	W01-358-6902	99
5065	W01-358-9105	38
5122	W01-358-2119	12
5235	W01-358-5423	14
5301	W01-358-8977	16
5307	W01-358-5423	14
5385	W01-358-8922	23
5492	W01-358-8922	23
5553	W01-358-8979	17
5691	W01-358-2120	12
6057	W01-358-8965	Call us
6104	W01-358-2120	12
6117	W01-358-5426	17
6250	W01-358-9478	15
6252	W01-358-9049	29
6352	W01-358-6943	104
6389	W01-358-6905	100
6390	W01-358-6944	104
6391	W01-358-7446	112
6392	W01-358-8008	120
6393	W01-358-8018	121
6394	W01-358-9122	85
6396	W01-358-9245	58
6418	W01-358-9082	46
6419	W01-358-7112	98
6420	W01-358-7135	106
6421	W01-358-7424	111
6424	W01-358-9121	82
6425	W01-358-9158	86
6426	W01-358-9177	83
6427	W01-358-9250	70
6428	W01-358-9275	69
6429	W01-358-9421	66
6941	W01-358-9101	57
7025	W01-358-6960	105
7026	W01-358-7855	Call us
7504	W01-358-5323	13
7593	W01-358-8760	80

MANUFACTURER/ PART NO.	FIRESTONE ASSEMBLY ORDER NO.	PAGE NO.
7692	W01-358-8918	Call us
7765	W01-358-5434	15
7831	W01-358-5436	Call us
7901	W01-358-8735	79
8221	W01-358-7996	120
8273	W01-358-9825	90
8609	W01-358-5702	17
9609	W01-358-5702	17
15634	W01-M58-8775	88
15635	W01-M58-6339	86
15698	W01-358-7447	112
15732	W01-M58-7074	62
15765	W01-358-5406	13
16002	W01-358-2119	12
1288201	W01-358-9082	46
1288202	W01-358-9121	82
1288301	W01-358-9101	57
1288302	W01-358-9122	85
1288401	W01-358-9223	48
1290601	W01-358-6927	104
1292801	W01-358-9010	41
1736001	W01-358-9308	34
1736101	W01-358-8900	Call us
1741401	W01-358-8991	37
1763601	W01-358-9349	Call us
1881301	W01-358-7555	117
1998301	W01-358-7557	117
2001801	W01-358-7555	117
2007401	W01-358-9332	Call us
2012401	W01-358-9966	50
2012402	W01-358-9966	50
2012412	W01-358-9966	50
2014201	W01-358-9947	52
2043701	W01-358-9333	35
2077200	W01-358-5775	66
2077301	W01-358-8959	28
2078301	W01-358-5775	66
2096601	W01-358-9474	50
2105401	W01-358-9377	Call us

PRIMARY TRUCK & TRAILER, AUXILIARY /TAG AXLE

MANUFACTURER TO FIRESTONE NUMBER

MANUFACTURER/ PART NO.	FIRESTONE ASSEMBLY ORDER NO.	PAGE NO.
2105501	W01-358-8976	Call us
2159801	W01-358-8964	33
2176701	W01-358-8776	Call us
2224101	W01-358-8932	37
2242501	W01-358-5777	67
2274701	W01-358-8720	75
2283601	W01-358-9691	Call us
2337701	W01-358-8961	33
2343301	W01-358-8740	74
2352101	W01-358-8855	56
2352102	W01-358-8856	56
2363101	W01-358-8050	91
2452001	W01-358-9320	59
2489401	W01-358-9690	Call us
2489402	W01-358-9690	Call us
2539601	W01-358-9560	25
2543701	W01-358-9559	Call us
7059511	W01-358-8636	Call us
70002901	W01-358-8735	79
70019501	W01-358-8735	79
70099901	W01-358-8733	Call us
70178401	W01-358-6886	103
70261401	W01-358-8824	45
70293201	W01-358-6856	98
70418501	W01-358-7897	103
70595101	W01-358-8636	Call us
11332/15664	W01-358-6808	108
1284401B	W01-358-9944	Call us
1288401A	W01-358-9223	48
1288401B	W01-358-9944	Call us
2012401A	W01-358-9966	50
2012401K	W01-358-9966	50
2014201K	W01-358-9947	52
93AR	W01-358-8018	121
UNIT RIG		
1001404	W01-358-7244	115
1016031	W01-358-7294	Call us
1016034	W01-358-9135	82

MANUFACTURER/ PART NO.	FIRESTONE ASSEMBLY ORDER NO.	PAGE NO.
VAN HOOL		
624319610	W01-358-9280	83
VIBERTI		
128147122	W01-M58-6339	86
VOLVO		
2076095	W01-358-7401	109
3130488	W01-358-7400	109
3130489	W01-358-7136	106
3130490	W01-358-9101	57
3130491	W01-358-9082	46
3130492	W01-358-9039	34
3130494	W01-358-9177	83
3130495	W01-358-9213	48
3130496	W01-358-9422	19
3130497	W01-358-9069	42
3130498	W01-358-8050	91
3130499	W01-358-9158	86
3130500	W01-358-9122	85
3130501	W01-358-7135	106
3130502	W01-358-7140	106
3130503	W01-358-9121	82
3130504	W01-358-7424	111
3180673	W01-358-8591	45
3934699	W01-358-8829	72
8061151	W01-358-9296	49
8079902	W01-358-8829	72
8161833	W01-358-9296	49
8169868	W01-358-9296	49
8169869	W01-358-9296	49
20413888	W01-358-8829	72
20505399	W01-358-8829	72
20733034	W01-M58-8463	72
350033201	W01-358-9219	48
350033203	W01-358-9219	48
350033204	W01-358-9219	48

PRIMARY TRUCK & TRAILER, AUXILIARY / TAG AXLE
MANUFACTURER TO FIRESTONE NUMBER

MANUFACTURER/ PART NO.	FIRESTONE ASSEMBLY ORDER NO.	PAGE NO.
350033209	W01-358-9219	48
350034409	W01-358-9466	49
352030005	W01-358-7145	106
352030005	W01-358-7146	106
352035001	W01-358-7403	110
3500033201	W01-358-9219	48
3500033204	W01-358-9219	48
3500033209	W01-358-9219	48
3522233203	W01-358-9219	48
8169868/69	W01-358-9296	49
VSTEER II		
LiftBag	W01-358-6943	104
WABASH (ROADTRAILER)		
	W01-358-8984	92
WATSON & CHALIN		
1R13155	W01-358-8637	77
AS-0039	W01-358-5523	90
AS0001	W01-358-6910	100
AS0002	W01-358-6902	99
AS0003	W01-358-7400	109
AS0004	W01-358-7136	106
AS0005	W01-358-7446	112
AS0006	W01-358-7798	123
AS0007	W01-358-7403	110
AS0008	W01-358-7140	106
AS0009	W01-358-7424	111
AS0011	W01-358-9082	46
AS0012	W01-358-9039	34
AS0013	W01-358-9121	82
AS0014	W01-358-7401	109
AS0015	W01-358-9105	38
AS0017	W01-358-9422	19
AS0019	W01-358-8008	120
AS00191F	W01-358-7994	119

MANUFACTURER/ PART NO.	FIRESTONE ASSEMBLY ORDER NO.	PAGE NO.
AS0020	W01-358-6905	100
AS0021	W01-358-6801	107
AS0023	W01-358-9122	85
AS00231F	W01-358-8792	85
AS0025	W01-358-7818	124
AS0026	W01-358-8997	19
AS0027	W01-358-7443	112
AS0028	W01-358-9083	46
AS0029	W01-358-5410	14
AS0030	W01-358-7325	113
AS0032	W01-358-7782	118
AS0033	W01-358-7839	125
AS0034	W01-358-6808	108
AS0035	W01-358-6908	100
AS0036	W01-358-9321	60
AS00361F	W01-358-9321	60
AS0038	W01-358-9192	57
AS0039	W01-358-8050	91
AS0039	W01-358-8052	91
AS0040	W01-358-9101	57
AS00401F	W01-358-9101	57
AS0041	W01-358-6943	104
AS0042	W01-358-5770	66
AS0043	W01-358-9004	Call us
AS0044	W01-358-9010	41
AS0045	W01-358-7273	115
AS00451F	W01-358-7273	115
AS0046	W01-358-9192	57
AS0047	W01-358-5503	86
AS00471G	W01-358-5514	87
AS0047F	W01-358-5503	86
AS0047GA	W01-358-5514	87
AS0048	W01-358-7990	119
AS0048	W01-358-8032	122
AS00481F	W01-358-7995	119

PRIMARY TRUCK & TRAILER, AUXILIARY /TAG AXLE

MANUFACTURER TO FIRESTONE NUMBER

MANUFACTURER/ PART NO.	FIRESTONE ASSEMBLY ORDER NO.	PAGE NO.
AS00482F	W01-358-7990	119
AS00482G	W01-358-7990	119
AS0049	W01-358-9362	49
AS0050	W01-358-9070	42
AS0053	W01-358-9336	43
AS0054	W01-358-9366	39
AS0056	W01-358-9346	59
AS0057	W01-358-9370	60
AS00571G	W01-358-9370	60
AS0058	W01-358-6897	99
AS00581F	W01-358-6886	103
AS0058S	W01-358-6897	99
AS0060	W01-358-9984	Call us
AS0061	W01-358-9243	58
AS00611F	W01-358-8861	56
AS00611G	W01-358-8861	56
AS0062	W01-358-8927	46
AS0063	W01-358-9915	88
AS0064	W01-358-7792	Call us
AS0068	W01-358-7705	114
AS0069	W01-358-5433	Call us
AS0070	W02-358-7022	Call us
AS0073	W01-358-9218	81
AS0075	W01-358-8018	121
AS0077	W01-358-9069	42
AS0078	W01-358-8052	91
AS0079	W01-358-9985	86
AS0081	W01-358-9985	86
AS0082	W01-358-9200	80
AS0083	W01-358-9228	Call us
AS0084	W01-358-8752	74
AS0084	W01-358-9270	71
AS0086	W01-358-7850	126
AS0087	W01-358-7550	117

MANUFACTURER/ PART NO.	FIRESTONE ASSEMBLY ORDER NO.	PAGE NO.
AS0087	W01-358-7555	117
AS00871F	W01-358-7545	116
AS0088	W01-358-7788	102
AS0088G	W01-358-7788	102
AS0089	W01-358-7557	117
AS0090	W01-358-9921	51
AS0092	W01-358-6883	102
AS0092G	W01-358-6883	102
AS0093	W01-358-7409	110
AS0094	W01-358-8752	74
AS0095	W01-358-9053	38
AS0096	W01-358-9250	70
AS0098	W01-358-8753	74
AS009801F	W01-358-8631	74
AS0099	W01-358-9929	Call us
AS0101	W01-358-9194	47
AS0103	W01-358-7304	124
AS0104	W01-358-9367	60
AS0106	W01-358-5297	18
AS0107F	W01-358-8637	77
AS0109	W01-358-7545	116
AS0110	W01-358-6805	108
AS0110G	W01-358-6805	108
AS0111	W01-358-6817	103
AS0112	W01-358-7472	116
AS0113F	W01-358-8825	45
AS0115G	W01-358-6944	104
AS0116	W01-358-2120	12
AS0117	W01-358-7949	117
AS0119F	W01-358-6945	104
AS0122G	W01-358-6948	105
AS0124F	W01-358-9158	86
AS0127G	W01-358-9373	53
AS0128G	W01-358-8053	91
AS0130	W01-358-9011	Call us

PRIMARY TRUCK & TRAILER, AUXILIARY / TAG AXLE

MANUFACTURER TO FIRESTONE NUMBER

MANUFACTURER/ PART NO.	FIRESTONE ASSEMBLY ORDER NO.	PAGE NO.
AS0136	W01-358-7410	111
AS0137	W01-358-9367	60
AS0139	W01-358-9371	53
AS0140	W01-358-9466	49
AS0141	W01-358-9373	53
AS0142	W01-358-9394	59
AS0143	W01-358-8900	Call us
AS0144	W01-358-8774	90
AS01451G	W01-358-6945	104
AS01461G	W01-358-7795	102
AS01471G	W01-358-9780	72
AS01481G	W01-358-9213	48
AS01491G	W01-358-7008	96
AS01541G	W01-358-7180	108
AS01561G	W01-358-6900	99
AS01561G	W01-358-6910	100
AS0159	W01-358-8774	90
AS01591G	W01-358-8774	90
AS01621G	W01-358-9804	86
AS01631G	W01-358-9243	58
AS01641G	W01-358-9935	51
AS0168G	W01-358-8033	122
AS0169	W01-358-9675	26
AS0170	W01-358-9471	69
AS0171	W01-358-9295	33
AS0173	W01-358-9597	31
AS0182	W01-358-9780	72
AS0183	W01-358-8806	40
AS01881F	W01-358-7180	108
LWLSL1100HLFLT	W01-358-7839	125
LWLSL1100SSRLW	W01-358-8008	120
LWLSL1100TTHLES	W01-358-7839	125
WCLWLSL1100	W01-358-8032	122
WCLWLSL1100LW	W01-358-8008	120
	W01-358-9350	59

MANUFACTURER/ PART NO.	FIRESTONE ASSEMBLY ORDER NO.	PAGE NO.
WEWELER		
US87408F	W01-M58-6339	86
US874313F	W01-M58-8775	88
USO7074F	W01-M58-7074	62
USO7337F	W01-M58-8775	88
USO7345F	W01-M58-6339	86
YORK		
785168	W01-M58-8775	88
785170	W01-M58-6339	86

PRIMARY TRUCK & TRAILER, AUXILIARY /TAG AXLE

GOODYEAR ASSEMBLY NUMBER TO FIRESTONE

GOODYEAR PART NO.	GOODYEAR BELLOWS NO.	FIRESTONE AON	PAGE NO.
566263081	566263050	W01-358-8723	74
1B12300	578913301	W01-358-7008	96
1B12301	578913301	W01-358-7009	96
1B12304		W01-358-7011	97
1B12305	578913301	W01-358-7043	97
1B12313	578913301	W01-358-7008	96
1B12322		W01-358-6994	96
1B12900	578913301	W01-358-7043	97
1B14350	578913351	W01-358-7103	97
1B14351	578913351	W01-358-7104	97
1B14358	578913352	W01-358-7112	98
1B5000		W01-358-7001	96
1B5500		W01-358-7001	96
1B8157		W01-358-7598	Call us
1B8159		W01-358-7598	Call us
1B8560		W01-358-7598	Call us
1B8563		W01-358-7598	Call us
1R10013	566243066	W01-358-9238	58
1R10036		W01-358-9049	29
1R10059	566203021	W01-358-9017	29
1R10078	566203021	W01-358-9017	29
1R10085	566203021	W01-358-9017	29
1R10087	566203021	W01-358-9017	29
1R10089	566203021	W01-358-9017	29
1R10090	566203021	W01-358-9017	29
1R10101	566203027	W01-358-5770	66
1R10105	566203021	W01-358-9652	31
1R10120	566203021	W01-358-9293	32
1R10122	566203021	W01-358-9291	32
1R10133	566203021	W01-358-9592	30
1R11018	566223006	W01-358-9073	29
1R11018	566223006	W01-358-9415	24
1R11028	566223021/022	W01-358-9422	19
1R11039	566223143	W01-358-9439	24

GOODYEAR PART NO.	GOODYEAR BELLOWS NO.	FIRESTONE AON	PAGE NO.
1R11039	566223043	W01-358-9441	24
1R11051	566223006	W01-358-9073	29
1R11066	566223021	W01-358-9447	21
1R11106		W01-M58-7074	62
1R11121	566223143	W01-358-9441	24
1R11130	566223049	W01-358-8828	62
1R11149	566223143	W01-358-8901	20
1R11150	566223021	W01-358-9448	21
1R11151	566223021	W01-358-9457	21
1R11152	566223021	W01-358-9459	22
1R11153		W01-358-8922	23
1R11159	566223021	W01-358-9387	21
1R11161	566223057	W01-358-5766	65
1R11166	566223048	W01-358-9295	33
1R11171	566223057	W01-358-9421	66
1R11172	566203021	W01-358-9291	32
1R11191	566223143	W01-358-8919	23
1R11200	566223021	W01-358-9376	20
1R11203	566223021	W01-358-9387	21
1R11219	566223021	W01-358-9617	25
1R11220	566223021	W01-358-9618	26
1R11221	566223021	W01-358-9622	26
1R11221	566223021	W01-358-9675	26
1R11222	566223021	W01-358-9625	26
1R11223	566223143	W01-358-9469	24
1R11225	566223057	W01-358-9650	65
1R11242	566223073	W01-358-9616	20
1R11249	566223084	W01-358-8616	77
1R11250		W01-358-9749	25
1R11252	566223042	W01-358-8903	63
1R11268	566223021	W01-358-9541	26
1R11268	566223021	W01-358-9547	25
1R11279	566223021/022	W01-358-9422	19
1R11280	566223021	W01-358-9622	26

PRIMARY TRUCK & TRAILER, AUXILIARY / TAG AXLE
GOODYEAR ASSEMBLY NUMBER TO FIRESTONE

GOODYEAR PART NO.	GOODYEAR BELLOWS NO.	FIRESTONE AON	PAGE NO.
1R11912	566203021	W01-358-9293	32
1R11913	566223048	W01-358-9295	33
1R11914	566203021	W01-358-9291	32
1R11915		W01-358-9294	32
1R11917	566243038	W01-358-9082	46
1R11918	566263018	W01-358-9121	82
1R12028	566243024	W01-358-9073	29
1R12066	566243038/048	W01-358-9083	46
1R12069	566243038/048	W01-358-9069	42
1R12076	566243076	W01-358-9101	57
1R12090	566243038	W01-358-9213	48
1R12092	566243038	W01-358-9082	46
1R12093	566243038	W01-358-9082	46
1R12095	566243067	W01-358-9039	34
1R12095	566243067	W01-358-9307	35
1R12097	566243050	W01-358-9039	34
1R12097SA	566243067	W01-358-9039	34
1R12103	566243066	W01-358-9101	57
1R121047	566243142	W01-358-9807	39
1R121048	566243097	W01-358-9974	53
1R121049		W01-M58-8468	73
1R121069	566243038	W01-358-9069	42
1R121070	566243038	W01-358-9082	46
1R121071	566243090	W01-358-9367	60
1R121072	566243108	W01-358-9780	72
1R121073	566243066	W01-358-9265	61
1R121074	566241000	W01-358-9371	53
1R121075	566241001	W01-358-9373	53
1R121076	566241001	W01-358-9375	54
1R121077	566243066	W01-358-1191	73
1R121078	566243067	W01-358-8204	36
1R121079	566243066	W01-358-1190	73
1R12108	566243066	W01-358-9203	57
1R121080	566241000	W01-358-9648	73

GOODYEAR PART NO.	GOODYEAR BELLOWS NO.	FIRESTONE AON	PAGE NO.
1R121081	566243066	W01-358-8852	56
1R121082	566243108	W01-358-9781	72
1R121083	566241008	W01-358-8829	72
1R12113	566243066	W01-358-9101	57
1R12115	566243061	W01-358-9031	34
1R12116	566243066	W01-358-9101	57
1R12122	566243050	W01-358-9039	34
1R12130	566243038	W01-358-9227	48
1R12132	566243076	W01-358-9105	38
1R12132	566243076	W01-358-9113	Call us
1R12132	566243076	W01-358-9302	Call us
1R12132	566243076	W01-358-9303	38
1R12133	566243050	W01-358-9039	34
1R12134	566243048	W01-358-9082	46
1R12135	566243066	W01-358-9101	57
1R12142	566243066	W01-358-9241	58
1R12142	566243090	W01-358-9321	60
1R12142	566243066	W01-358-9394	59
1R12143	566243038	W01-358-9392	49
1R12143	566243048	W01-358-9392	49
1R12145	566243066	W01-358-9238	58
1R12151	566243038	W01-358-9219	48
1R12152	566243076	W01-358-9105	38
1R12155	566243038	W01-358-9096	47
1R12165	566243076	W01-358-9302	Call us
1R12167	566243066	W01-358-9192	57
1R12167	566243066	W01-358-9245	58
1R12173	566243173	W01-358-9466	49
1R12178	566243067	W01-358-9379	27
1R12182	566243038	W01-358-9219	48
1R12182	566243110	W01-358-9219	48
1R12185	566243066	W01-358-9192	57
1R12186	566243275	W01-358-9780	72
1R12188	566243038	W01-358-9223	48

PRIMARY TRUCK & TRAILER, AUXILIARY /TAG AXLE

GOODYEAR ASSEMBLY NUMBER TO FIRESTONE

GOODYEAR PART NO.	GOODYEAR BELLOWS NO.	FIRESTONE AON	PAGE NO.
1R12189	566243038	W01-358-9082	46
1R12189	566243108	W01-358-9780	72
1R12189 / 1R12303	566243108	W01-358-9780	72
1R12195	566243066	W01-358-9349	Call us
1R12197	566243180	W01-358-9466	49
1R12204	566243067	W01-358-9565	27
1R12204	566243067	W01-358-9566	27
1R12205	566241012	W01-358-9567	27
1R12205	566243076	W01-358-9568	28
1R12220	566243038	W01-358-9092	46
1R12256	566243090	W01-358-9321	60
1R12256	566243090	W01-358-9367	60
1R12261	566243066	W01-358-9241	58
1R12261	566243093	W01-358-9394	59
1R12264	566263080	W01-358-8708	78
1R12265	566243066	W01-358-9203	57
1R12265	566243066	W01-358-9245	58
1R12275	566243066	W01-358-9240	58
1R12278	566243066	W01-358-9394	59
1R12279	566243066	W01-358-9394	59
1R12281	566243066	W01-358-9130	57
1R12281	566243066	W01-358-9394	59
1R12283	566243090	W01-358-9367	60
1R12303	566243275	W01-358-9780	72
1R12309	566243067	W01-358-9053	38
1R12324	566243067	W01-358-9565	27
1R12324	566243067	W01-358-9566	27
1R12325	566243076	W01-358-9567	27
1R12335	566243090	W01-358-9321	60
1R12350	566243061	W01-358-9031	34
1R12350	566243067	W01-358-9031	34
1R12351	566243061	W01-358-9033	34
1R12352	566243076	W01-358-9010	41
1R12355	566243076	W01-358-9078	38

GOODYEAR PART NO.	GOODYEAR BELLOWS NO.	FIRESTONE AON	PAGE NO.
1R12356	566243038	W01-358-9194	47
1R12357	566243066	W01-358-9348	59
1R12358	566243038	W01-358-9096	47
1R12363	566243090	W01-358-9320	59
1R12365	566243038	W01-358-9466	49
1R12365	566243074	W01-358-9466	49
1R12365	566243173	W01-358-9466	49
1R12365	566243180	W01-358-9466	49
1R12366	566243038	W01-358-8944	61
1R12366	566243074	W01-358-8944	61
1R12366	566243038	W01-358-9299	64
1R12367	566243091	W01-358-9640	63
1R12370	566243076	W01-358-9070	42
1R12370	566243076	W01-358-9336	43
1R12372	566243038	W01-358-9471	69
1R12373	566243080	W01-358-9491	70
1R12375	566243066	W01-358-9265	61
1R12383	566243061	W01-358-9306	35
1R12387	566243038	W01-358-9473	69
1R12388	566243038	W01-358-9501	70
1R12389	566243038	W01-358-9473	69
1R12395	566243066	W01-358-9203	57
1R12398	566243038	W01-358-9648	73
1R12398	566241000	W01-358-9648	73
1R12400	566243038	W01-358-9296	49
1R12401	566243038	W01-358-9371	53
1R12402	566243097	W01-358-9297	53
1R12402 / 1S12029	566241007	W01-358-9297	53
1R12403	566243097	W01-358-9373	53
1R12403 / 1S12030	566241019	W01-358-9373	53
1R12403 / 1S12030	566243111	W01-358-9375	54
1R12404	566243097	W01-358-9375	54
1R12405	566243097	W01-358-8829	72

PRIMARY TRUCK & TRAILER, AUXILIARY / TAG AXLE
GOODYEAR ASSEMBLY NUMBER TO FIRESTONE

GOODYEAR PART NO.	GOODYEAR BELLOWS NO.	FIRESTONE AON	PAGE NO.
1R12405	566243110	W01-358-8829	72
1R12405	566241010	W01-358-8829	72
1R12421	566243076	W01-358-9010	41
1R12423	566243038	W01-358-8591	45
1R12424	566243097	W01-358-9287	53
1R12424 / 1S12027	566243225	W01-358-9287	53
1R12432	566243066	W01-358-1191	73
1R12434	566243076	W01-358-8802	40
1R12435	566243067	W01-358-9307	35
1R12435	566243067	W01-358-9334	35
1R12436	566243038	W01-358-8924	45
1R12437	566243076	W01-358-9797	44
1R12438	566243038	W01-358-8805	40
1R12439	566243066	W01-358-9346	59
1R12440	566243090	W01-358-9370	60
1R12441	566243038	W01-358-9362	49
1R12445	566243076	W01-358-8802	40
1R12445	566243076	W01-358-8806	40
1R12446	566243097	W01-358-9245	58
1R1245	566243076	W01-358-8806	40
1R12450	566243097	W01-358-9342	50
1R12465	566243067	W01-358-8963	33
1R12467	566243116	W01-358-0783	55
1R12480	566243066	W01-358-9243	58
1R12481	566243097	W01-358-9923	51
1R12484	566243038	W01-358-9504	70
1R12485	566243038	W01-358-9501	70
1R12486	566243038	W01-358-9473	69
1R12486	566243038	W01-358-9504	70
1R12487	566243067	W01-358-9366	39
1R12488	566241001	W01-358-9375	54
1R12492	566243076	W01-358-8806	40
1R12494	566243038	W01-358-1096	45
1R12498	566243097	W01-358-9922	51

GOODYEAR PART NO.	GOODYEAR BELLOWS NO.	FIRESTONE AON	PAGE NO.
1R12499	566243038	W01-358-9936	52
1R12501	566203021	W01-358-9293	32
1R12502	566243097	W01-358-9921	51
1R12503	566243090	W01-358-9370	60
1R12504	566243066	W01-358-9471	69
1R12505	566243076	W01-358-9325	39
1R12508	566243067	W01-358-8204	36
1R12508	566243067	W01-358-9307	35
1R12508	566243067	W01-358-9334	35
1R12509	566243038	W01-358-9082	46
1R12522	566243067	W01-358-8204	36
1R12523	566243066	W01-358-1190	73
1R12523	566243086	W01-358-1190	73
1R12530	566243061	W01-358-9306	35
1R12531	566243061	W01-358-8970	35
1R12532	566243097	W01-358-9935	51
1R12533	566243097	W01-358-9923	51
1R12534	566243116	W01-358-8861	56
1R12536	566243097	W01-358-8829	72
1R12536	566243110	W01-358-8829	72
1R12538	566243000	W01-358-9648	73
1R12538	566243038	W01-358-9648	73
1R12539	566241000	W01-358-9648	73
1R12540	566243038	W01-358-9902	51
1R12541	566243038	W01-358-8825	45
1R12543	90557275	W01-358-9507	44
1R12552	566243038	W01-358-9471	69
1R12553	566243038	W01-358-9472	69
1R12553	566243038	W01-358-9491	70
1R12554	566243038	W01-358-9470	69
1R12555	566243067	W01-358-8961	33
1R12556	566243067	W01-358-8964	33
1R12560	566243067	W01-358-9308	34
1R12562	566243067	W01-358-8197	36

PRIMARY TRUCK & TRAILER, AUXILIARY /TAG AXLE

GOODYEAR ASSEMBLY NUMBER TO FIRESTONE

GOODYEAR PART NO.	GOODYEAR BELLOWS NO.	FIRESTONE AON	PAGE NO.
1R12566	566243067	W01-358-8964	33
1R12567	566243038	W01-358-9026	46
1R12568	566243066	W01-358-8852	56
1R12571	566243067	W01-358-9365	39
1R12580	566243117	W01-358-9370	60
1R12586	566243038	W01-358-9473	69
1R12595	566241008	W01-358-8829	72
1R12603	566243275	W01-358-9780	72
1R12603	566243108	W01-358-9781	72
1R12603	566243275	W01-358-9781	72
1R12613		W01-358-8855	56
1R12614	566243076	W01-358-9303	38
1R12615	566243097	W01-358-8829	72
1R12620	566243076	W01-358-9335	43
1R12621	566243097	W01-358-9093	47
1R12636		W01-358-9634	63
1R12639	566243066	W01-358-9240	58
1R12640	566243038	W01-358-9902	51
1R12644		W01-358-8855	56
1R12645	566243038	W01-358-9210	47
1R12647		W01-M58-8463	72
1R12648	566243076	W01-358-9336	43
1r12654		W01-M58-8468	73
1R12663	566207006	W01-358-9320	59
1R12669	566243038	W01-358-9069	42
1R12676	566243038	W01-358-9069	42
1R12677	566243038	W01-358-9082	46
1R12689	566243066	W01-358-1192	73
1R12714	566243066	W01-358-9130	57
1R12900	566243038	W01-358-9096	47
1R12901	566243055	W01-358-9053	38
1R12902	566243074	W01-358-9466	49
1R12903	566243038	W01-358-9223	48
1R12905	566243066	W01-358-9130	57

GOODYEAR PART NO.	GOODYEAR BELLOWS NO.	FIRESTONE AON	PAGE NO.
1R12905	566243066	W01-358-9394	59
1R12907	566243038	W01-358-9026	46
1R12909	566243097	W01-358-9921	51
1R12910	566243097	W01-358-9923	51
1R12911	566243097	W01-358-9922	51
1R12916		W01-358-9268	63
1R13038	566263015/072	W01-358-9122	85
1R13039	566263051/018	W01-358-9121	82
1R13039 / 1R13043 / 1R13049	566263018	W01-358-9121	82
1R13043	566263051	W01-358-9121	82
1R13045	566263072	W01-358-9122	85
1R13045	566263072	W01-358-9156	85
1R13047	566263051	W01-358-9144	82
1R13048	566263072	W01-358-9122	85
1R13049	566263051	W01-358-9121	82
1R13067	566263018	W01-358-9121	82
1R13077	566263036	W01-358-9270	71
1R13087	566263050	W01-358-8723	74
1R13097	566263050	W01-358-8723	74
1R13097	566263081	W01-358-8752	74
1R13102	566263036	W01-358-9270	71
1R13109	566263050	W01-358-8782	75
1R13115	566263044	W01-358-9250	70
1R13117	566263043	W01-358-9275	69
1R13118	566263039	W01-358-9580	79
1R13118	566263068	W01-358-9580	79
1R13118	566263034/068	W01-358-9580	79
1R13119	566263053/040	W01-358-9270	71
1R13119 / 1R13077 / 1R13102	566263037	W01-358-9270	71
1R13120	566263054	W01-358-9218	81
1R13124	566263050	W01-358-8710	79
1R13124	566263050	W01-358-8755	75

PRIMARY TRUCK & TRAILER, AUXILIARY / TAG AXLE
GOODYEAR ASSEMBLY NUMBER TO FIRESTONE

GOODYEAR PART NO.	GOODYEAR BELLOWS NO.	FIRESTONE AON	PAGE NO.
1R13128	566263080	W01-358-8708	78
1R13130	566263055	W01-358-8729	76
1R13138	566263050	W01-358-8752	74
1R13139		W01-358-8760	80
1R13140	566263078	W01-358-8713	78
1R13144	566263144	W01-358-9580	79
1R13152	566263071	W01-358-8748	76
1R13153	566263071	W01-358-8749	76
1R13155	566263051	W01-358-8637	77
1R13155	566263051	W01-358-8637	77
1R13159	566263073	W01-358-8709	78
1R13176	566263078	W01-358-8713	78
1R13177	566263080	W01-358-8708	78
1R13188	566263078	W01-358-8539	80
1R13207	566263081	W01-358-8753	74
1R13208	566263071	W01-358-8746	75
1R13210	566263081	W01-358-8740	74
1R13257	566263072	W01-358-9122	85
1R13258	566263039	W01-358-9580	79
1R13259	566263036	W01-358-9270	71
1R13260	566263050	W01-358-8755	75
1R13261	566263055	W01-358-8729	76
1R13262	566263073	W01-358-8709	78
1R13263	566263078	W01-358-8713	78
1R13264	566263080	W01-358-8708	78
1R13908	566283021	W01-358-9134	84
1R14018	566283021	W01-358-9149	83
1R14019	566283020	W01-358-9156	85
1R14024	566283021	W01-358-9149	83
1R14025	566283020	W01-358-9156	85
1R14026	566283021	W01-358-9148	83
1R14027	566283021	W01-358-9148	83
1R14028	566283021	W01-358-9177	83
1R14028	566283021	W01-358-9230	Call us

GOODYEAR PART NO.	GOODYEAR BELLOWS NO.	FIRESTONE AON	PAGE NO.
1R14029	566283021	W01-358-9177	83
1R14030	566283020	W01-358-9158	86
1R14031	566283020	W01-358-9158	86
1R14033		W01-358-9206	81
1R14037	566283015	W01-358-9215	81
1R14038	566283015	W01-358-9200	80
1R14039	566283015	W01-358-8050	91
1R14039 / 1R14055 / 1R14083	566283023	W01-358-8050	91
1R14041		W01-358-9206	81
1R14042	566283015	W01-358-8052	91
1R14043	566283011	W01-358-9121	82
1R14045	566283020	W01-358-8792	85
1R14045	566283020	W01-358-9122	85
1R14054	566283020	W01-358-9158	86
1R14055	566283015	W01-358-8050	91
1R14059		W01-M58-8775	88
1R14060	566283020	W01-358-9122	85
1R14068	566283015	W01-358-9200	80
1R14083	566283023	W01-358-8050	91
1R14094	566283015	W01-358-8053	91
1R14113	566283030	W01-358-5505	87
1R14127	566283029	W01-358-9264	88
1R14130	566283021	W01-358-8778	81
1R14137	566283021	W01-358-9134	84
1R14147	566283015	W01-358-8053	91
1R14151	AS01621G	W01-358-9804	86
1R14160	566283021	W01-358-9144	82
1R14170	566283020	W01-358-5514	87
1R14171	566283015	W01-358-8091	89
1R14172	566283042	W01-358-8774	90
1R14174	566283020	W01-358-5503	86
1R14177	566283021	W01-358-9280	83
1R14183	566283042	W01-358-8774	90

PRIMARY TRUCK & TRAILER, AUXILIARY /TAG AXLE

GOODYEAR ASSEMBLY NUMBER TO FIRESTONE

GOODYEAR PART NO.	GOODYEAR BELLOWS NO.	FIRESTONE AON	PAGE NO.
1R14190	566283044	W01-358-8774	90
1R14215		W01-358-9141	82
1R14218	566283021	W01-358-8980	82
1R14244	566283015	W01-358-8050	91
1R14245	566283015	W01-358-8091	89
1R14729		W01-M58-6348	89
1R14857		W01-M58-6339	86
1R8005		W01-358-5405	13
1R8005		W01-358-5710	17
1R8005	566163007	W01-358-5730	16
1R8009		W01-358-5310	12
1R8009		W01-358-5311	12
1R8016		W01-358-5710	17
1R8016	566163007	W01-358-5730	16
1R8020		W01-358-5712	17
1R8021		W01-358-5405	13
1R8025	566163007	W01-358-5730	16
1R8026	566163007	W01-358-5730	16
1R8034		W01-358-5710	17
1R8034	566163007	W01-358-5730	16
1R9003	566183010	W01-358-5406	13
1R9003		W01-358-5712	17
1R9019	566183003	W01-358-2119	12
1R9019	566183003	W01-358-8997	19
1R9038	566183010	W01-358-5406	13
1R9040		W01-358-5405	13
1R9041		W01-358-5310	12
1R9065	566183003	W01-358-2119	12
1R9065	566183003	W01-358-8997	19
1R9070	566183004	W01-358-5410	14
1S12002	566241008	W01-358-8829	72
1S12022	566241008	W01-358-9296	49
1S12027	566241001	W01-358-9287	53
1S12027	566241012	W01-358-9287	53

GOODYEAR PART NO.	GOODYEAR BELLOWS NO.	FIRESTONE AON	PAGE NO.
1S12027	566243077	W01-358-9287	53
1S12029	566241001	W01-358-9297	53
1S12029	566241012	W01-358-9297	53
1S12030	566241001	W01-358-9373	53
1S12030	566241012	W01-358-9373	53
1S12030	566241012	W01-358-9375	54
1S12031	566241001	W01-358-9375	54
1S12033	566241010	W01-358-8829	72
1S12035	566241014	W01-358-8829	72
1S12244	566241000	W01-358-9371	53
1S12245	566241008	W01-358-9296	49
1S4.5107		W02-358-7080	136
1S4.5113		W02-358-7056	140
1S4.5121		W02-358-7035	138
1S4007		W02-358-7001	131
1S4007		W02-358-7002	131
1S4007		W02-358-7031	135
1S4008		W02-358-7010	133
1S4008		W02-358-7012	139
1S4035	ASC087163 (piston)	W02-358-7046	130
1S4035	ASC087163 (piston)	W02-358-7055	134
1S4044	ASC087194 (piston)	W02-358-7001	131
1S4056	ASC087194 (piston)	W02-358-7040	134
1S4058	579087139	W02-358-7086	130
1S4067	ASC087137 (piston)	W02-358-7007	136
1S4123	579087157	W02-358-7046	130
1S4175	ASC087157 (piston)	W02-358-7086	130
1S45121	ASC087157 (piston)	W02-358-7108	142
1S5005	ASC0807005 (piston)	W02-358-7012	139
1S5006	ASC087005 (piston)	W02-358-7014	144
1S5006	ASC087005 (piston)	W02-358-7017	141

PRIMARY TRUCK & TRAILER, AUXILIARY / TAG AXLE
GOODYEAR ASSEMBLY NUMBER TO FIRESTONE

GOODYEAR PART NO.	GOODYEAR BELLOWS NO.	FIRESTONE AON	PAGE NO.
1S5006	ASC087005 (piston)	W02-358-7042	140
1S5006	ASC087005 (piston)	W02-358-7044	Call us
1S5038	ASC087194 (piston)	W02-358-7081	145
1S5040	ASC087137 (piston)	W02-358-7087	138
1S5055	ASC0807005 (piston)	W02-358-7017	141
1S5057	579087157	W02-358-7108	142
1S5120	579087194	W02-358-7014	144
1S5120	579087194	W02-358-7017	141
1S5120	579087194	W02-358-7042	140
1S5120	579087194	W02-358-7044	Call us
1S5152	579087219	W02-358-7110	146
1S5157	579087139	W02-358-7064	142
1S5175		W02-358-7205	143
1S5175		W02-358-7215	144
1S5176		W02-358-7206	138
1S5186		W02-358-7036	143
1S6067	ASC087137 (piston)	W02-358-7007	136
2B10226	578923202	W01-358-6927	104
2B10226	578923250	W01-358-7795	102
2B12300	578923309	W01-358-7424	111
2B12304	578923309	W01-358-7344	109
2B12305	578923310	W01-358-7443	112
2B12307	578923309	W01-358-7403	110
2B12309	578923309	W01-358-7400	109
2B12311	578923309	W01-358-7180	108
2B12312	578923309	W01-358-7404	110
2B12313	578923309	W01-358-7405	110
2B12316	578923309	W01-358-7400	109
2B12318	578923309	W01-358-7185	109
2B12319	578923305/309	W01-358-7409	110
2B12320	578923305/309	W01-358-7401	109
2B12320	578923309	W01-358-7437	111

GOODYEAR PART NO.	GOODYEAR BELLOWS NO.	FIRESTONE AON	PAGE NO.
2B12324	578923310/309	W01-358-7447	112
2B12324	578923310/309	W01-358-7790	113
2B12345	578923315	W01-358-7545	116
2B12346	578923315	W01-358-7550	117
2B12402	578923310/309	W01-358-7446	112
2B12406	578923305/309	W01-358-7410	111
2B12406	578923309	W01-358-7410	111
2B12410	578923309	W01-358-7404	110
2B12411	578923309	W01-358-7181	108
2B12412	578923309	W01-358-7183	109
2B12416	578923315	W01-358-7444	112
2B12425	578923309	W01-358-7180	108
2B12427	578923309	W01-358-7429	111
2B12428	578923310	W01-358-7473	112
2B12432	578923309	W01-358-7423	111
2B12433	578923309	W01-358-7403	110
2B12434	578923310	W01-358-7472	116
2B12437	578923309	W01-358-7180	108
2B12440	578923315	W01-358-7550	117
2B12440	578923315	W01-358-7555	117
2B12445	578923309	W01-358-7403	110
2B12446	578923310	W01-358-7444	112
2B12459	578923309	W01-358-7405	110
2B14350	578923353	W01-358-7145	106
2B14351	578923353	W01-358-7146	106
2B14354	578923353	W01-358-7145	106
2B14355	578923353	W01-358-7146	106
2B14356	578923351/353	W01-358-7136	106
2B14359	578923351/353	W01-358-7140	106
2B14359	578923353	W01-358-7782	118
2B14360	578923351/353	W01-358-7135	106
2B14361	578923356	W01-358-6801	107
2B14362		W01-358-6800	107
2B14363	578923356	W01-358-9529	108

PRIMARY TRUCK & TRAILER, AUXILIARY /TAG AXLE

GOODYEAR ASSEMBLY NUMBER TO FIRESTONE

GOODYEAR PART NO.	GOODYEAR BELLOWS NO.	FIRESTONE AON	PAGE NO.
2B14365	578923356	W01-358-6801	107
2B14366	578923353	W01-358-6803	107
2B14367	578923353	W01-358-7123	105
2B14383	578923356	W01-358-7557	117
2B14450		W01-358-6800	107
2B14451	578923356	W01-358-9529	108
2B14452	578923356	W01-358-6801	107
2B14453	578923351	W01-358-7136	106
2B14462	578923356	W01-358-6805	108
2B14464		W01-358-8171	107
2B14470	578923356	W01-358-7782	118
2B14476	578923356	W01-358-6799	117
2B15375		W01-358-6800	107
2B15376	578923356	W01-358-6801	107
2B15377	578923356	W01-358-9529	108
2B15378	578923356	W01-358-9529	108
2B6050		W01-358-7025	119
2B6052		W01-358-7025	119
2B6053		W01-358-7025	119
2B6530		W01-358-7025	119
2B6531		W01-358-7025	119
2B6532		W01-358-7025	119
2B7540	579923525	W01-358-3400	116
2B7541	579923525	W01-358-3400	116
2B7542	579923525	W01-358-3400	116
2B7548		W01-358-7659	114
2B8150	579923530	W01-358-7325	113
2B8153	579923530	W01-358-7325	113
2B8155	578923202	W01-358-6910	100
2B8157	578923202	W01-358-6900	99
2B82152	579923530	W01-358-7325	113
2B8550	579923530	W01-358-7325	113
2B8553	579923530	W01-358-7325	113
2B8554	579923530	W01-358-7325	113

GOODYEAR PART NO.	GOODYEAR BELLOWS NO.	FIRESTONE AON	PAGE NO.
2B9200	578923202	W01-358-6910	100
2B9201	578923202	W01-358-6902	99
2B9201	578923202	W01-358-6935	101
2B9202	578923202	W01-358-6910	100
2B9204	578923202	W01-358-6900	99
2B9206	578923202	W01-358-6905	100
2B9207	578923202	W01-358-6900	99
2B9209	578923200	W01-358-6905	100
2B9210	578923202	W01-358-6908	100
2B9216	578923202	W01-358-6900	99
2B9216	578923202	W01-358-6910	100
2B9218	578923202	W01-358-6927	104
2B9218	578923202	W01-358-6940	101
2B9228	556238325	W01-358-6897	99
2B9229	578923202	W01-358-6897	99
2B9229	556238225	W01-358-6897	99
2B9230	578923202	W01-358-6940	101
2B9239	578923211	W01-358-6902	99
2B9245	578923202	W01-358-7788	102
2B9246	578923211	W01-358-6932	100
2B9246	578923211	W01-358-6944	104
2B9250	578923206	W01-358-6943	104
2B9251	578923206	W01-358-6948	105
2B9252	578923202	W01-358-6941	101
2B9252	578923206	W01-358-6944	104
2B9252	578923208	W01-358-6944	104
2B9253	578923206	W01-358-6945	104
2B9254	578923206	W01-358-6946	104
2B9255	578923206	W01-358-6947	105
2B9258	578923206	W01-358-6947	105
2B9265	578923202	W01-358-6941	101
2B9266	578923206	W01-358-6944	104
2B9280	578923206	W01-358-6941	101
2B9288	578923211	W01-358-6926	100

PRIMARY TRUCK & TRAILER, AUXILIARY / TAG AXLE
GOODYEAR ASSEMBLY NUMBER TO FIRESTONE

GOODYEAR PART NO.	GOODYEAR BELLOWS NO.	FIRESTONE AON	PAGE NO.
2B9352	578923208	W01-358-6944	104
2B9492	578923202	W01-358-6910	100
2B9493	578923202	W01-358-6935	101
2B9494	556238225	W01-358-6897	99
2B9606	578923211	W01-358-6890	99
2B9607	578923208	W01-358-6962	105
3B12300	578933100	W01-358-8008	120
3B12300	578933100	W01-358-8025	121
3B12301	578933100	W01-358-8010	120
3B12301	578933100	W01-358-8030	121
3B12303	578933100	W01-358-8018	121
3B12304	578933100	W01-358-8006	120
3B12310	578933100	W01-358-8027	121
3B12312	578933100	W01-358-8033	122
3B12315	578933100	W01-358-8032	122
3B12319	578933100	W01-358-8032	122
3B12322	578933103	W01-358-8042	127
3B12323	578933103	W01-358-8043	127
3B12324	578933100	W01-358-7990	119
3B12328	578933100	W01-358-7994	119
3B12329	578933100	W01-358-7990	119
3B12329	578933100	W01-358-7995	119
3B12335	578933100	W01-358-7996	120
3B12415	578933105	W01-358-8038	127
3B12416	578933105	W01-358-8039	127
3B14350	578933350	W01-358-7808	124
3B14354	578933351 /350	W01-358-7808	124
3B14356	578933350	W01-358-7798	123
3B14356	578933350	W01-358-7838	Call us
3B14359	578933351/350	W01-358-7818	124
3B14359	578933350	W01-358-7839	125
3B14360	578933351/350	W01-358-7800	123
3B14360	578933350	W01-358-7848	126
3B14364	578933350	W01-358-7843	125

GOODYEAR PART NO.	GOODYEAR BELLOWS NO.	FIRESTONE AON	PAGE NO.
3B14365	578933351/350	W01-358-7846	125
3B14367	578933350	W01-358-7796	123
3B14367	578933350	W01-358-7847	125
3B14370	566338335	W01-358-7850	126
3B14382	556338335	W01-358-7850	126
3B14444	578933350	W01-358-7839	125
3B14450	556338335	W01-358-7845	125
3B14451	556338335	W01-358-7846	125
3B14452	556338335	W01-358-7850	126
3B14453	578933350	W01-358-7838	Call us
3B14456	578933350	W01-358-7839	125
3B14457	556338335	W01-358-7843	125
3B14459	556338335	W01-358-7847	125
3B14464	556338335	W01-358-7862	126

PRIMARY TRUCK & TRAILER, AUXILIARY /TAG AXLE

GOODYEAR BELLOWS NUMBERTO FIRESTONE

GOODYEAR BELLOWS NO.	GOODYEAR PART NO.	FIRESTONE AON	PAGE NO.
90557275	1R12543	W01-358-9507	44
556238225	2B9494	W01-358-6897	99
556238225	2B9229	W01-358-6897	99
556238325	2B9228	W01-358-6897	99
556338335	3B14457	W01-358-7843	125
556338335	3B14450	W01-358-7845	125
556338335	3B14451	W01-358-7846	125
556338335	3B14459	W01-358-7847	125
556338335	3B14382	W01-358-7850	126
556338335	3B14452	W01-358-7850	126
556338335	3B14464	W01-358-7862	126
566163007	1R8005	W01-358-5730	16
566163007	1R8016	W01-358-5730	16
566163007	1R8025	W01-358-5730	16
566163007	1R8026	W01-358-5730	16
566163007	1R8034	W01-358-5730	16
566183003	1R9019	W01-358-2119	12
566183003	1R9065	W01-358-2119	12
566183003	1R9019	W01-358-8997	19
566183003	1R9065	W01-358-8997	19
566183004	1R9070	W01-358-5410	14
566183010	1R9003	W01-358-5406	13
566183010	1R9038	W01-358-5406	13
566203021	1R10059	W01-358-9017	29
566203021	1R10078	W01-358-9017	29
566203021	1R10085	W01-358-9017	29
566203021	1R10087	W01-358-9017	29
566203021	1R10089	W01-358-9017	29
566203021	1R10090	W01-358-9017	29
566203021	1R10122	W01-358-9291	32
566203021	1R11172	W01-358-9291	32
566203021	1R11914	W01-358-9291	32
566203021	1R10120	W01-358-9293	32
566203021	1R11912	W01-358-9293	32
566203021	1R12501	W01-358-9293	32
566203021	1R10133	W01-358-9592	30
566203021	1R10105	W01-358-9652	31
566203027	1R10101	W01-358-5770	66

GOODYEAR BELLOWS NO.	GOODYEAR PART NO.	FIRESTONE AON	PAGE NO.
566207006	1R12663	W01-358-9320	59
566223006	1R11018	W01-358-9073	29
566223006	1R11051	W01-358-9073	29
566223006	1R11018	W01-358-9415	24
566223021	1R11200	W01-358-9376	20
566223021	1R11159	W01-358-9387	21
566223021	1R11203	W01-358-9387	21
566223021	1R11066	W01-358-9447	21
566223021	1R11150	W01-358-9448	21
566223021	1R11151	W01-358-9457	21
566223021	1R11152	W01-358-9459	22
566223021	1R11268	W01-358-9541	26
566223021	1R11268	W01-358-9547	25
566223021	1R11219	W01-358-9617	25
566223021	1R11220	W01-358-9618	26
566223021	1R11221	W01-358-9622	26
566223021	1R11280	W01-358-9622	26
566223021	1R11222	W01-358-9625	26
566223021	1R11221	W01-358-9675	26
566223042	1R11252	W01-358-8903	63
566223043	1R11039	W01-358-9441	24
566223048	1R11166	W01-358-9295	33
566223048	1R11913	W01-358-9295	33
566223049	1R11130	W01-358-8828	62
566223057	1R11161	W01-358-5766	65
566223057	1R11171	W01-358-9421	66
566223057	1R11225	W01-358-9650	65
566223073	1R11242	W01-358-9616	20
566223084	1R11249	W01-358-8616	77
566223143	1R11149	W01-358-8901	20
566223143	1R11191	W01-358-8919	23
566223143	1R11039	W01-358-9439	24
566223143	1R11121	W01-358-9441	24
566223143	1R11223	W01-358-9469	24
566241000	1R121074	W01-358-9371	53
566241000	1S12244	W01-358-9371	53
566241000	1R121080	W01-358-9648	73
566241000	1R12539	W01-358-9648	73

PRIMARY TRUCK & TRAILER, AUXILIARY / TAG AXLE
GOODYEAR BELLOWS NUMBER TO FIRESTONE

GOODYEAR BELLOWS NO.	GOODYEAR PART NO.	FIRESTONE AON	PAGE NO.
566241000	1R12398	W01-358-9648	73
566241001	1S12027	W01-358-9287	53
566241001	1S12029	W01-358-9297	53
566241001	1R121075	W01-358-9373	53
566241001	1S12030	W01-358-9373	53
566241001	1R121076	W01-358-9375	54
566241001	1R12488	W01-358-9375	54
566241001	1S12031	W01-358-9375	54
566241007	1R12402 / 1S12029	W01-358-9297	53
566241008	1R121083	W01-358-8829	72
566241008	1R12595	W01-358-8829	72
566241008	1S12002	W01-358-8829	72
566241008	1S12022	W01-358-9296	49
566241008	1S12245	W01-358-9296	49
566241010	1S12033	W01-358-8829	72
566241010	1R12405	W01-358-8829	72
566241012	1S12027	W01-358-9287	53
566241012	1S12029	W01-358-9297	53
566241012	1S12030	W01-358-9373	53
566241012	1S12030	W01-358-9375	54
566241012	1R12205	W01-358-9567	27
566241014	1S12035	W01-358-8829	72
566241019	1R12403 / 1S12030	W01-358-9373	53
566243000	1R12538	W01-358-9648	73
566243024	1R12028	W01-358-9073	29
566243038	1R12494	W01-358-1096	45
566243038	1R12423	W01-358-8591	45
566243038	1R12438	W01-358-8805	40
566243038	1R12541	W01-358-8825	45
566243038	1R12436	W01-358-8924	45
566243038	1R12366	W01-358-8944	61
566243038	1R12567	W01-358-9026	46
566243038	1R12907	W01-358-9026	46
566243038	1R121069	W01-358-9069	42
566243038	1R12669	W01-358-9069	42
566243038	1R12676	W01-358-9069	42
566243038	1R11917	W01-358-9082	46

GOODYEAR BELLOWS NO.	GOODYEAR PART NO.	FIRESTONE AON	PAGE NO.
566243038	1R12092	W01-358-9082	46
566243038	1R12093	W01-358-9082	46
566243038	1R121070	W01-358-9082	46
566243038	1R12189	W01-358-9082	46
566243038	1R12509	W01-358-9082	46
566243038	1R12677	W01-358-9082	46
566243038	1R12220	W01-358-9092	46
566243038	1R12155	W01-358-9096	47
566243038	1R12358	W01-358-9096	47
566243038	1R12900	W01-358-9096	47
566243038	1R12356	W01-358-9194	47
566243038	1R12645	W01-358-9210	47
566243038	1R12090	W01-358-9213	48
566243038	1R12151	W01-358-9219	48
566243038	1R12182	W01-358-9219	48
566243038	1R12188	W01-358-9223	48
566243038	1R12903	W01-358-9223	48
566243038	1R12130	W01-358-9227	48
566243038	1R12400	W01-358-9296	49
566243038	1R12366	W01-358-9299	64
566243038	1R12441	W01-358-9362	49
566243038	1R12401	W01-358-9371	53
566243038	1R12143	W01-358-9392	49
566243038	1R12365	W01-358-9466	49
566243038	1R12554	W01-358-9470	69
566243038	1R12372	W01-358-9471	69
566243038	1R12552	W01-358-9471	69
566243038	1R12553	W01-358-9472	69
566243038	1R12387	W01-358-9473	69
566243038	1R12389	W01-358-9473	69
566243038	1R12486	W01-358-9473	69
566243038	1R12586	W01-358-9473	69
566243038	1R12553	W01-358-9491	70
566243038	1R12388	W01-358-9501	70
566243038	1R12485	W01-358-9501	70
566243038	1R12484	W01-358-9504	70
566243038	1R12486	W01-358-9504	70
566243038	1R12398	W01-358-9648	73

PRIMARY TRUCK & TRAILER, AUXILIARY /TAG AXLE

GOODYEAR BELLOWS NUMBERTO FIRESTONE

GOODYEAR BELLOWS NO.	GOODYEAR PART NO.	FIRESTONE AON	PAGE NO.
566243038	1R12538	W01-358-9648	73
566243038	1R12540	W01-358-9902	51
566243038	1R12640	W01-358-9902	51
566243038	1R12499	W01-358-9936	52
566243048	1R12134	W01-358-9082	46
566243048	1R12143	W01-358-9392	49
566243050	1R12097	W01-358-9039	34
566243050	1R12122	W01-358-9039	34
566243050	1R12133	W01-358-9039	34
566243055	1R12901	W01-358-9053	38
566243061	1R12531	W01-358-8970	35
566243061	1R12115	W01-358-9031	34
566243061	1R12350	W01-358-9031	34
566243061	1R12351	W01-358-9033	34
566243061	1R12383	W01-358-9306	35
566243061	1R12530	W01-358-9306	35
566243066	1R121079	W01-358-1190	73
566243066	1R12523	W01-358-1190	73
566243066	1R121077	W01-358-1191	73
566243066	1R12432	W01-358-1191	73
566243066	1R12689	W01-358-1192	73
566243066	1R121081	W01-358-8852	56
566243066	1R12568	W01-358-8852	56
566243066	1R12103	W01-358-9101	57
566243066	1R12113	W01-358-9101	57
566243066	1R12116	W01-358-9101	57
566243066	1R12135	W01-358-9101	57
566243066	1R12281	W01-358-9130	57
566243066	1R12714	W01-358-9130	57
566243066	1R12905	W01-358-9130	57
566243066	1R12167	W01-358-9192	57
566243066	1R12185	W01-358-9192	57
566243066	1R12108	W01-358-9203	57
566243066	1R12265	W01-358-9203	57
566243066	1R12395	W01-358-9203	57
566243066	1R10013	W01-358-9238	58
566243066	1R12145	W01-358-9238	58
566243066	1R12275	W01-358-9240	58

GOODYEAR BELLOWS NO.	GOODYEAR PART NO.	FIRESTONE AON	PAGE NO.
566243066	1R12639	W01-358-9240	58
566243066	1R12142	W01-358-9241	58
566243066	1R12261	W01-358-9241	58
566243066	1R12480	W01-358-9243	58
566243066	1R12167	W01-358-9245	58
566243066	1R12265	W01-358-9245	58
566243066	1R121073	W01-358-9265	61
566243066	1R12375	W01-358-9265	61
566243066	1R12439	W01-358-9346	59
566243066	1R12357	W01-358-9348	59
566243066	1R12195	W01-358-9349	Call us
566243066	1R12142	W01-358-9394	59
566243066	1R12278	W01-358-9394	59
566243066	1R12279	W01-358-9394	59
566243066	1R12281	W01-358-9394	59
566243066	1R12905	W01-358-9394	59
566243066	1R12504	W01-358-9471	69
566243067	1R12562	W01-358-8197	36
566243067	1R121078	W01-358-8204	36
566243067	1R12508	W01-358-8204	36
566243067	1R12522	W01-358-8204	36
566243067	1R12555	W01-358-8961	33
566243067	1R12465	W01-358-8963	33
566243067	1R12556	W01-358-8964	33
566243067	1R12566	W01-358-8964	33
566243067	1R12350	W01-358-9031	34
566243067	1R12095	W01-358-9039	34
566243067	1R12097SA	W01-358-9039	34
566243067	1R12095	W01-358-9039	34
566243067	1R12309	W01-358-9053	38
566243067	1R12095	W01-358-9307	35
566243067	1R12435	W01-358-9307	35
566243067	1R12508	W01-358-9307	35
566243067	1R12560	W01-358-9308	34
566243067	1R12435	W01-358-9334	35
566243067	1R12508	W01-358-9334	35
566243067	1R12571	W01-358-9365	39
566243067	1R12487	W01-358-9366	39

PRIMARY TRUCK & TRAILER, AUXILIARY / TAG AXLE
GOODYEAR BELLOWS NUMBER TO FIRESTONE

GOODYEAR BELLOWS NO.	GOODYEAR PART NO.	FIRESTONE AON	PAGE NO.
566243067	1R12178	W01-358-9379	27
566243067	1R12204	W01-358-9565	27
566243067	1R12324	W01-358-9565	27
566243067	1R12204	W01-358-9566	27
566243067	1R12324	W01-358-9566	27
566243074	1R12366	W01-358-8944	61
566243074	1R12902	W01-358-9466	49
566243074	1R12365	W01-358-9466	49
566243076	1R12434	W01-358-8802	40
566243076	1R12445	W01-358-8802	40
566243076	1R12445	W01-358-8806	40
566243076	1R1245	W01-358-8806	40
566243076	1R12492	W01-358-8806	40
566243076	1R12352	W01-358-9010	41
566243076	1R12421	W01-358-9010	41
566243076	1R12370	W01-358-9070	42
566243076	1R12355	W01-358-9078	38
566243076	1R12076	W01-358-9101	57
566243076	1R12132	W01-358-9105	38
566243076	1R12152	W01-358-9105	38
566243076	1R12132	W01-358-9113	Call us
566243076	1R12132	W01-358-9302	Call us
566243076	1R12165	W01-358-9302	Call us
566243076	1R12132	W01-358-9303	38
566243076	1R12614	W01-358-9303	38
566243076	1R12505	W01-358-9325	39
566243076	1R12620	W01-358-9335	43
566243076	1R12370	W01-358-9336	43
566243076	1R12648	W01-358-9336	43
566243076	1R12325	W01-358-9567	27
566243076	1R12205	W01-358-9568	28
566243076	1R12437	W01-358-9797	44
566243077	1S12027	W01-358-9287	53
566243080	1R12373	W01-358-9491	70
566243086	1R12523	W01-358-1190	73
566243090	1R12363	W01-358-9320	59
566243090	1R12142	W01-358-9321	60
566243090	1R12256	W01-358-9321	60

GOODYEAR BELLOWS NO.	GOODYEAR PART NO.	FIRESTONE AON	PAGE NO.
566243090	1R12335	W01-358-9321	60
566243090	1R121071	W01-358-9367	60
566243090	1R12256	W01-358-9367	60
566243090	1R12283	W01-358-9367	60
566243090	1R12440	W01-358-9370	60
566243090	1R12503	W01-358-9370	60
566243091	1R12367	W01-358-9640	63
566243093	1R12261	W01-358-9394	59
566243097	1R12405	W01-358-8829	72
566243097	1R12536	W01-358-8829	72
566243097	1R12615	W01-358-8829	72
566243097	1R12621	W01-358-9093	47
566243097	1R12446	W01-358-9245	58
566243097	1R12424	W01-358-9287	53
566243097	1R12402	W01-358-9297	53
566243097	1R12450	W01-358-9342	50
566243097	1R12403	W01-358-9373	53
566243097	1R12404	W01-358-9375	54
566243097	1R12502	W01-358-9921	51
566243097	1R12909	W01-358-9921	51
566243097	1R12498	W01-358-9922	51
566243097	1R12911	W01-358-9922	51
566243097	1R12481	W01-358-9923	51
566243097	1R12533	W01-358-9923	51
566243097	1R12910	W01-358-9923	51
566243097	1R12532	W01-358-9935	51
566243097	1R121048	W01-358-9974	53
566243108	1R121072	W01-358-9780	72
566243108	1R12189	W01-358-9780	72
566243108	1R12189 / 1R12303	W01-358-9780	72
566243108	1R121082	W01-358-9781	72
566243108	1R12603	W01-358-9781	72
566243110	1R12405	W01-358-8829	72
566243110	1R12536	W01-358-8829	72
566243110	1R12182	W01-358-9219	48
566243111	1R12403 / 1S12030	W01-358-9375	54
566243116	1R12467	W01-358-0783	55

PRIMARY TRUCK & TRAILER, AUXILIARY /TAG AXLE

GOODYEAR BELLOWS NUMBERTO FIRESTONE

GOODYEAR BELLOWS NO.	GOODYEAR PART NO.	FIRESTONE AON	PAGE NO.
566243116	1R12534	W01-358-8861	56
566243117	1R12580	W01-358-9370	60
566243142	1R121047	W01-358-9807	39
566243173	1R12173	W01-358-9466	49
566243173	1R12365	W01-358-9466	49
566243180	1R12197	W01-358-9466	49
566243180	1R12365	W01-358-9466	49
566243225	1R12424 / 1S12027	W01-358-9287	53
566243275	1R12186	W01-358-9780	72
566243275	1R12303	W01-358-9780	72
566243275	1R12603	W01-358-9780	72
566243275	1R12603	W01-358-9780	72
566243275	1R12603	W01-358-9781	72
566263018	1R11918	W01-358-9121	82
566263018	1R13067	W01-358-9121	82
566263018	1R13039 / 1R13043 / 1R13049	W01-358-9121	82
566263036	1R13077	W01-358-9270	71
566263036	1R13102	W01-358-9270	71
566263036	1R13259	W01-358-9270	71
566263037	1R13119 / 1R13077 / 1R13102	W01-358-9270	71
566263039	1R13118	W01-358-9580	79
566263039	1R13258	W01-358-9580	79
566263043	1R13117	W01-358-9275	69
566263044	1R13115	W01-358-9250	70
566263050	1R13124	W01-358-8710	79
566263050	566263081	W01-358-8723	74
566263050	1R13087	W01-358-8723	74
566263050	1R13097	W01-358-8723	74
566263050	1R13087 or 097	W01-358-8723	74
566263050	1R13138	W01-358-8752	74
566263050	1R13124	W01-358-8755	75
566263050	1R13260	W01-358-8755	75
566263050	1R13109	W01-358-8782	75
566263051	1R13155	W01-358-8637	77
566263051	1R13043	W01-358-9121	82
566263051	1R13049	W01-358-9121	82

GOODYEAR BELLOWS NO.	GOODYEAR PART NO.	FIRESTONE AON	PAGE NO.
566263051	1R13047	W01-358-9144	82
566263054	1R13120	W01-358-9218	81
566263055	1R13130	W01-358-8729	76
566263055	1R13261	W01-358-8729	76
566263068	1R13118	W01-358-9580	79
566263071	1R13208	W01-358-8746	75
566263071	1R13152	W01-358-8748	76
566263071	1R13153	W01-358-8749	76
566263072	1R13045	W01-358-9122	85
566263072	1R13048	W01-358-9122	85
566263072	1R13257	W01-358-9122	85
566263072	1R13045	W01-358-9156	85
566263073	1R13159	W01-358-8709	78
566263073	1R13262	W01-358-8709	78
566263078	1R13188	W01-358-8539	80
566263078	1R13140	W01-358-8713	78
566263078	1R13176	W01-358-8713	78
566263078	1R13263	W01-358-8713	78
566263080	1R12264	W01-358-8708	78
566263080	1R13128	W01-358-8708	78
566263080	1R13177	W01-358-8708	78
566263080	1R13264	W01-358-8708	78
566263081	1R13210	W01-358-8740	74
566263081	1R13097	W01-358-8752	74
566263081	1R13207	W01-358-8753	74
566263144	1R13144	W01-358-9580	79
566283011	1R14043	W01-358-9121	82
566283015	1R14039	W01-358-8050	91
566283015	1R14055	W01-358-8050	91
566283015	1R14244	W01-358-8050	91
566283015	1R14042	W01-358-8052	91
566283015	1R14094	W01-358-8053	91
566283015	1R14147	W01-358-8053	91
566283015	1R14171	W01-358-8091	89
566283015	1R14245	W01-358-8091	89
566283015	1R14038	W01-358-9200	80
566283015	1R14068	W01-358-9200	80
566283015	1R14037	W01-358-9215	81

PRIMARY TRUCK & TRAILER, AUXILIARY / TAG AXLE
GOODYEAR BELLOWS NUMBER TO FIRESTONE

GOODYEAR BELLOWS NO.	GOODYEAR PART NO.	FIRESTONE AON	PAGE NO.
566283020	1R14174	W01-358-5503	86
566283020	1R14170	W01-358-5514	87
566283020	1R14045	W01-358-8792	85
566283020	1R14045	W01-358-9122	85
566283020	1R14060	W01-358-9122	85
566283020	1R14019	W01-358-9156	85
566283020	1R14025	W01-358-9156	85
566283020	1R14030	W01-358-9158	86
566283020	1R14031	W01-358-9158	86
566283020	1R14054	W01-358-9158	86
566283021	1R14130	W01-358-8778	81
566283021	1R14218	W01-358-8980	82
566283021	1R13908	W01-358-9134	84
566283021	1R14137	W01-358-9134	84
566283021	1R14160	W01-358-9144	82
566283021	1R14026	W01-358-9148	83
566283021	1R14027	W01-358-9148	83
566283021	1R14018	W01-358-9149	83
566283021	1R14024	W01-358-9149	83
566283021	1R14028	W01-358-9177	83
566283021	1R14029	W01-358-9177	83
566283021	1R14028	W01-358-9230	Call us
566283021	1R14177	W01-358-9280	83
566283023	1R14083	W01-358-8050	91
566283023	1R14039 / 1R14055 / 1R14083	W01-358-8050	91
566283029	1R14127	W01-358-9264	88
566283030	1R14113	W01-358-5505	87
566283042	1R14172	W01-358-8774	90
566283042	1R14183	W01-358-8774	90
566283044	1R14190	W01-358-8774	90
566338335	3B14370	W01-358-7850	126
578913301	1B12300	W01-358-7008	96
578913301	1B12313	W01-358-7008	96
578913301	1B12301	W01-358-7009	96
578913301	1B12305	W01-358-7043	97
578913301	1B12900	W01-358-7043	97
578913351	1B14350	W01-358-7103	97

GOODYEAR BELLOWS NO.	GOODYEAR PART NO.	FIRESTONE AON	PAGE NO.
578913351	1B14351	W01-358-7104	97
578913352	1B14358	W01-358-7112	98
578923200	2B9209	W01-358-6905	100
578923202	2B9229	W01-358-6897	99
578923202	2B8157	W01-358-6900	99
578923202	2B9204	W01-358-6900	99
578923202	2B9207	W01-358-6900	99
578923202	2B9216	W01-358-6900	99
578923202	2B9201	W01-358-6902	99
578923202	2B9206	W01-358-6905	100
578923202	2B9210	W01-358-6908	100
578923202	2B8155	W01-358-6910	100
578923202	2B9200	W01-358-6910	100
578923202	2B9202	W01-358-6910	100
578923202	2B9216	W01-358-6910	100
578923202	2B9492	W01-358-6910	100
578923202	2B10226	W01-358-6927	104
578923202	2B9218	W01-358-6927	104
578923202	2B9201	W01-358-6935	101
578923202	2B9493	W01-358-6935	101
578923202	2B9218	W01-358-6940	101
578923202	2B9230	W01-358-6940	101
578923202	2B9252	W01-358-6941	101
578923202	2B9265	W01-358-6941	101
578923202	2B9245	W01-358-7788	102
578923206	2B9280	W01-358-6941	101
578923206	2B9250	W01-358-6943	104
578923206	2B9252	W01-358-6944	104
578923206	2B9266	W01-358-6944	104
578923206	2B9253	W01-358-6945	104
578923206	2B9254	W01-358-6946	104
578923206	2B9255	W01-358-6947	105
578923206	2B9258	W01-358-6947	105
578923206	2B9251	W01-358-6948	105
578923208	2B9352	W01-358-6944	104
578923208	2B9252	W01-358-6944	104
578923208	2B9607	W01-358-6962	105
578923211	2B9606	W01-358-6890	99

PRIMARY TRUCK & TRAILER, AUXILIARY /TAG AXLE

GOODYEAR BELLOWS NUMBERTO FIRESTONE

GOODYEAR BELLOWS NO.	GOODYEAR PART NO.	FIRESTONE AON	PAGE NO.
578923211	2B9239	W01-358-6902	99
578923211	2B9288	W01-358-6926	100
578923211	2B9246	W01-358-6932	100
578923211	2B9246	W01-358-6944	104
578923250	2B10226	W01-358-7795	102
578923309	2B12311	W01-358-7180	108
578923309	2B12425	W01-358-7180	108
578923309	2B12437	W01-358-7180	108
578923309	2B12411	W01-358-7181	108
578923309	2B12412	W01-358-7183	109
578923309	2B12318	W01-358-7185	109
578923309	2B12304	W01-358-7344	109
578923309	2B12309	W01-358-7400	109
578923309	2B12316	W01-358-7400	109
578923309	2B12307	W01-358-7403	110
578923309	2B12433	W01-358-7403	110
578923309	2B12445	W01-358-7403	110
578923309	2B12312	W01-358-7404	110
578923309	2B12410	W01-358-7404	110
578923309	2B12313	W01-358-7405	110
578923309	2B12459	W01-358-7405	110
578923309	2B12406	W01-358-7410	111
578923309	2B12432	W01-358-7423	111
578923309	2B12300	W01-358-7424	111
578923309	2B12427	W01-358-7429	111
578923309	2B12320	W01-358-7437	111
578923310	2B12305	W01-358-7443	112
578923310	2B12446	W01-358-7444	112
578923310	2B12434	W01-358-7472	116
578923310	2B12428	W01-358-7473	112
578923315	2B12416	W01-358-7444	112
578923315	2B12345	W01-358-7545	116
578923315	2B12346	W01-358-7550	117
578923315	2B12440	W01-358-7550	117
578923315	2B12440	W01-358-7555	117
578923351	2B14453	W01-358-7136	106
578923353	2B14366	W01-358-6803	107
578923353	2B14367	W01-358-7123	105

GOODYEAR BELLOWS NO.	GOODYEAR PART NO.	FIRESTONE AON	PAGE NO.
578923353	2B14350	W01-358-7145	106
578923353	2B14354	W01-358-7145	106
578923353	2B14351	W01-358-7146	106
578923353	2B14355	W01-358-7146	106
578923353	2B14359	W01-358-7782	118
578923356	2B14476	W01-358-6799	117
578923356	2B14361	W01-358-6801	107
578923356	2B14365	W01-358-6801	107
578923356	2B14452	W01-358-6801	107
578923356	2B15376	W01-358-6801	107
578923356	2B14462	W01-358-6805	108
578923356	2B14383	W01-358-7557	117
578923356	2B14470	W01-358-7782	118
578923356	2B14363	W01-358-9529	108
578923356	2B14451	W01-358-9529	108
578923356	2B15377	W01-358-9529	108
578923356	2B15378	W01-358-9529	108
578933100	3B12324	W01-358-7990	119
578933100	3B12329	W01-358-7990	119
578933100	3B12328	W01-358-7994	119
578933100	3B12329	W01-358-7995	119
578933100	3B12335	W01-358-7996	120
578933100	3B12304	W01-358-8006	120
578933100	3B12300	W01-358-8008	120
578933100	3B12301	W01-358-8010	120
578933100	3B12303	W01-358-8018	121
578933100	3B12300	W01-358-8025	121
578933100	3B12310	W01-358-8027	121
578933100	3B12301	W01-358-8030	121
578933100	3B12315	W01-358-8032	122
578933100	3B12319	W01-358-8032	122
578933100	3B12312	W01-358-8033	122
578933103	3B12322	W01-358-8042	127
578933103	3B12323	W01-358-8043	127
578933105	3B12415	W01-358-8038	127
578933105	3B12416	W01-358-8039	127
578933350	3B14367	W01-358-7796	123
578933350	3B14356	W01-358-7798	123

PRIMARY TRUCK & TRAILER, AUXILIARY / TAG AXLE
GOODYEAR BELLOWS NUMBER TO FIRESTONE

GOODYEAR BELLOWS NO.	GOODYEAR PART NO.	FIRESTONE AON	PAGE NO.
578933350	3B14350	W01-358-7808	124
578933350	3B14356	W01-358-7838	Call us
578933350	3B14453	W01-358-7838	Call us
578933350	3B14359	W01-358-7839	125
578933350	3B14444	W01-358-7839	125
578933350	3B14456	W01-358-7839	125
578933350	3B14364	W01-358-7843	125
578933350	3B14367	W01-358-7847	125
578933350	3B14360	W01-358-7848	126
579087139	1S5157	W02-358-7064	142
579087139	1S4058	W02-358-7086	130
579087157	1S4123	W02-358-7046	130
579087157	1S5057	W02-358-7108	142
579087194	1S5120	W02-358-7014	144
579087194	1S5120	W02-358-7017	141
579087194	1S5120	W02-358-7042	140
579087194	1S5120	W02-358-7044	Call us
579087219	1S5152	W02-358-7110	146
579923525	2B7540	W01-358-3400	116
579923525	2B7541	W01-358-3400	116
579923525	2B7542	W01-358-3400	116
579923530	2B8150	W01-358-7325	113
579923530	2B8153	W01-358-7325	113
579923530	2B82152	W01-358-7325	113
579923530	2B8550	W01-358-7325	113
579923530	2B8553	W01-358-7325	113
579923530	2B8554	W01-358-7325	113
566223021/022	1R11028	W01-358-9422	19
566223021/022	1R11279	W01-358-9422	19
566243038/048	1R12069	W01-358-9069	42
566243038/048	1R12066	W01-358-9083	46
566263015/072	1R13038	W01-358-9122	85
566263034/068	1R13118	W01-358-9580	79
566263051/018	1R13039	W01-358-9121	82
566263053/040	1R13119	W01-358-9270	71
578923305/309	2B12320	W01-358-7401	109
578923305/309	2B12319	W01-358-7409	110
578923305/309	2B12406	W01-358-7410	111

GOODYEAR BELLOWS NO.	GOODYEAR PART NO.	FIRESTONE AON	PAGE NO.
578923310/309	2B12402	W01-358-7446	112
578923310/309	2B12324	W01-358-7447	112
578923310/309	2B12324	W01-358-7790	113
578923351/353	2B14360	W01-358-7135	106
578923351/353	2B14356	W01-358-7136	106
578923351/353	2B14359	W01-358-7140	106
578933351/350	3B14360	W01-358-7800	123
578933351/350	3B14354	W01-358-7808	124
578933351/350	3B14359	W01-358-7818	124
578933351/350	3B14365	W01-358-7846	125
AS01621G	1R14151	W01-358-9804	86
ASC0807005 (piston)	1S5005	W02-358-7012	139
ASC0807005 (piston)	1S5055	W02-358-7017	141
ASC087005 (piston)	1S5006	W02-358-7014	144
ASC087005 (piston)	1S5006	W02-358-7017	141
ASC087005 (piston)	1S5006	W02-358-7042	140
ASC087005 (piston)	1S5006	W02-358-7044	Call us
ASC087137 (piston)	1S4067	W02-358-7007	136
ASC087137 (piston)	1S6067	W02-358-7007	136
ASC087137 (piston)	1S5040	W02-358-7087	138
ASC087157 (piston)	1S4175	W02-358-7086	130
ASC087157 (piston)	1S45121	W02-358-7108	142
ASC087163 (piston)	1S4035	W02-358-7046	130
ASC087163 (piston)	1S4035	W02-358-7055	134
ASC087194 (piston)	1S4044	W02-358-7001	131
ASC087194 (piston)	1S4056	W02-358-7040	134
ASC087194 (piston)	1S5038	W02-358-7081	145

PRIMARY TRUCK & TRAILER, AUXILIARY /TAG AXLE

CONTITECH ASSEMBLY NUMBER TO FIRESTONE

CONTITECH BELLOWS NO.	FIRESTONE AON	PAGE NO.
91019	W01-358-9101	57
10 10-15 S 518	W01-358-8752	74
10 10-15 S 522	W01-358-8710	79
10 10-15 S 522	W01-358-8755	75
10 10-15 S 713	W01-358-8753	74
10 10-15 S 773	W01-358-8740	74
10 10-15 S 871	W01-358-8782	75
10 10-16 S 526	W01-358-8708	78
10 10-16 S 533	W01-358-8713	78
10 10-16.5 S 783	W01-358-9121	82
10 10-21 P 434	W01-358-9580	79
10 10-21 P 486	W01-358-8749	76
10 10-21 P 570	W01-358-8748	76
10 10-21 P 774	W01-358-8746	75
10 10.5-15 P 460	W01-358-8709	78
10 10.5AV-12 P 513	W01-358-8729	76
101015S453	W01-358-8709	78
101015S711	W01-358-8710	79
101015S962	W01-358-8723	74
101021P015	W01-358-9581	79
101021P964	W01-358-8744	75
1010515P480	W01-358-8709	78
1010B13S513	W01-358-8729	76
11 10.5-15 A 414	W01-358-9215	81
11 10.5-15 A 415	W01-358-9200	80
11 10.5-15 A 422	W01-358-9218	81
11 10.5-17 A 316	W01-358-9177	83
11 10.5-17 A 364	W01-358-9148	83
11 10.5-17 A 377	W01-358-9144	82
11 10.5-17 A 507	W01-358-8778	81
11 10.5-19 A 431	W01-358-9134	84
11 10.5-21 A 313	W01-358-8792	85
11 10.5-21 A 313	W01-358-9122	85
11 10.5-21 A 318	W01-358-9158	86
11 10.5-21 A 365	W01-358-9149	83
11 10.5-22 S 712	W01-358-9264	88
11 10.5A-16 P 523	W01-358-8091	89
11 10.5C-16 A 320	W01-358-8050	91
11 10.5C-16 A 378	W01-358-8052	91

CONTITECH BELLOWS NO.	FIRESTONE AON	PAGE NO.
11 10.5C-16 A 380	W01-358-8053	91
11 10.5F-17 P 745	W01-358-8774	90
1110517A317	W01-358-9121	82
1110517A368	W01-358-9135	82
1110517A388	W01-358-9221	83
1110519A432	W01-358-9138	85
1110519A508	W01-358-8779	84
1110519A509	W01-358-8780	84
1110519A557	W01-358-8781	84
1110521A025	W01-358-8764	Call us
1110521A370	W01-358-9156	85
1110522A530	W01-358-5503	86
1110522A530	W01-358-5511	87
1110522A712	W01-358-9264	88
1110522A931	W01-358-5511	87
1110522S750	W01-358-5505	87
11105B18P743	W01-358-8093	89
11105E16A378	W01-358-8052	91
11105E16A380	W01-358-8053	91
4023 N P03	W01-M58-6348	89
4157 N P09	W01-M58-7074	62
4159NP04	W01-358-9101	57
6 6.5-13 S 039	W01-358-5406	13
6 6.5-13 S 446	W01-358-5410	14
6 6.5B-11 S 027	W01-358-2119	12
6 6.5D-11 S 525	W01-358-8997	19
66511S028	W01-358-2120	12
66511S029	W01-358-2131	12
66511S030	W01-358-5310	12
66511S031	W01-358-5311	12
66511S032	W01-358-5323	13
66513S038	W01-358-5405	13
66513S040	W01-358-5408	13
66513S041	W01-358-5412	14
66513S042	W01-358-5414	14
66513S043	W01-358-5422	14
66513S044	W01-358-5433	Call us
66513S045	W01-358-5434	15
66513S046	W01-358-5436	Call us

PRIMARY TRUCK & TRAILER, AUXILIARY / TAG AXLE
CONTITECH ASSEMBLY NUMBER TO FIRESTONE

CONTITECH BELLOWS NO.	FIRESTONE AON	PAGE NO.
66513S047	W01-358-9478	15
66513S559	W01-358-5423	14
665B11S034	W01-358-5297	18
665B11S035	W01-358-5319	18
665B11S037	W01-358-8992	19
665B11S054	W01-358-5298	18
81010P481	W01-358-9333	35
813 MB	W01-M58-6339	86
9 10-10 P 311	W01-358-9039	34
9 10-10 P 328	W01-358-9033	34
9 10-10 P 339	W01-358-9031	34
9 10-10 P 398	W01-358-9308	34
9 10-10 P 471	W01-358-9307	35
9 10-10 P 473	W01-358-8963	33
9 10-10 P 480	W01-358-8964	33
9 10-10 P 482	W01-358-9334	35
9 10-10 P 542	W01-358-8961	33
9 10-12 A 327	W01-358-9053	38
9 10-12 A 427	W01-358-9640	63
9 10-12 P 024	W01-358-8197	36
9 10-12 P 319	W01-358-9105	38
9 10-12 P 319	W01-358-9302	Call us
9 10-12 P 329	W01-358-9078	38
9 10-12 P 395	W01-358-9325	39
9 10-12 P 484	W01-358-8204	36
9 10-12 P 488	W01-358-9366	39
9 10-12 P 495	W01-358-9365	39
9 10-13.5 P 874	W01-358-9807	39
9 10-13.5 S 433	W01-358-9270	71
9 10-14 A 330	W01-358-9070	42
9 10-14 A 496	W01-358-9797	44
9 10-14 A 545	W01-358-8806	40
9 10-14 A 575	W01-358-9634	63
9 10-14 P 312	W01-358-9069	42
9 10-14 P 345	W01-358-9010	41
9 10-14 P 450	W01-358-9568	28
9 10-14 P 461	W01-358-9567	27
9 10-14 P 462	W01-358-8805	40
9 10-14 P 465	W01-358-9335	43

CONTITECH BELLOWS NO.	FIRESTONE AON	PAGE NO.
9 10-14 P 469	W01-358-8802	40
9 10-14 P 490	W01-358-9336	43
9 10-16 A 382	W01-358-9781	72
9 10-16 A 999	W01-358-9781	72
9 10-16 P 310	W01-358-9082	46
9 10-16 P 325	W01-358-9096	47
9 10-16 P 332	W01-358-9093	47
9 10-16 P 333	W01-358-9083	46
9 10-16 P 352	W01-358-9194	47
9 10-16 P 353	W01-358-9227	48
9 10-16 P 372	W01-358-9092	46
9 10-16 P 376	W01-358-9392	49
9 10-16 P 391	W01-358-9362	49
9 10-16 P 393	W01-358-9026	46
9 10-16 P 407	W01-358-9213	48
9 10-16 P 408	W01-358-9219	48
9 10-16 P 409	W01-358-9223	48
9 10-16 P 410	W01-358-9466	49
9 10-16 P 416	W01-358-9296	49
9 10-16 P 449	W01-358-8829	72
9 10-16 P 497	W01-358-8924	45
9 10-17.5 A 930	W01-358-9974	53
9 10-17.5 P 418	W01-358-9342	50
9 10-17.5 P 426	W01-358-9902	51
9 10-17.5 P 428	W01-358-9922	51
9 10-17.5 P 429	W01-358-9923	51
9 10-17.5 P 436	W01-358-8944	61
9 10-17.5 P 436	W01-358-9299	64
9 10-17.5 P 443	W01-358-9921	51
9 10-17.5 P 445	W01-358-9473	69
9 10-17.5 P 454	W01-358-9936	52
9 10-17.5 P 502	W01-358-9471	69
9 10-17.5 P 536	W01-358-8903	63
9 10-17.5 P 548	W01-358-9935	51
9 10-17.5 P 571	W01-358-9470	69
9 10-17.5 P 572	W01-358-9471	69
9 10-17.5 P 573	W01-358-9472	69
9 10-17.5 P 573	W01-358-9491	70
9 10-18.5 P 406	W01-358-9287	53

PRIMARY TRUCK & TRAILER, AUXILIARY /TAG AXLE

CONTITECH ASSEMBLY NUMBER TO FIRESTONE

CONTITECH BELLOWS NO.	FIRESTONE AON	PAGE NO.
9 10-18.5 P 440	W01-358-9373	53
9 10-18.5 P 451	W01-358-9375	54
9 10-18.5 P 456	W01-358-9648	73
9 10-18.5 P 519	W01-358-9373	53
9 10-18.5 P 520	W01-358-9297	53
9 10-18.5 P 521	W01-358-9371	53
9 10-19 A 358	W01-358-9130	57
9 10-19 A 358	W01-358-9241	58
9 10-19 A 358	W01-358-9394	59
9 10-19 P 315	W01-358-9101	57
9 10-19 P 326	W01-358-9192	57
9 10-19 P 355	W01-358-9203	57
9 10-19 P 356	W01-358-9238	58
9 10-19 P 357	W01-358-9240	58
9 10-19 P 358	W01-358-9394	59
9 10-19 P 384	W01-358-9243	58
9 10-19 P 390	W01-358-9245	58
9 10-19 P 435	W01-358-9265	61
9 10-19 P 438	W01-358-9349	Call us
9 10-19 P 439	W01-358-9348	59
9 10-19 P 470	W01-358-9346	59
9 10-19 P 472	W01-358-8852	56
9 10-19 P 552	W01-358-8855	56
9 10-19 P 946	W01-358-9241	58
9 10-21 A 505	W01-358-9367	60
9 10-21 P 360	W01-358-9320	59
9 10-21 P 361	W01-358-9321	60
9 10-21 P 448	W01-358-9370	60
9 10-21 P 505	W01-358-9367	60
9 10B-17.5 A 323	W01-358-9275	69
9 10B-17.5 P 554	W01-358-9491	70
9 10B-19.5 P 889	W01-358-1191	73
9 10D-21 A 324	W01-358-9250	70
9 10S-16 P 382	W01-358-9780	72
9 9-10 P 538	W01-358-9625	26
9 9-10 P 576	W01-358-9675	26
9 9-10 P 862	W01-358-9618	26
9 9-12 P 314	W01-358-9422	19
9 9-12 P 379	W01-358-9379	27

CONTITECH BELLOWS NO.	FIRESTONE AON	PAGE NO.
9 9-12 P 464	W01-358-8901	20
9 9-12 P 477	W01-358-9376	20
9 9-12 P 479	W01-358-9387	21
9 9-12 P 515	W01-358-9616	20
9 9-12 P 563	W01-358-9448	21
9 9-12 P 705	W01-358-9421	66
9 9-14 A 337	W01-358-9439	24
9 9-14 A 337	W01-358-9441	24
9 9-14 P 517	W01-358-8919	23
9 9-9 P 537	W01-358-9622	26
9 9-9 P 859	W01-358-9541	26
9 9-9 P 859	W01-358-9547	25
9 9-9 P 860	W01-358-9617	25
9 9K-15 P 417	W01-358-9295	33
9 9K-15 P 424	W01-358-9293	32
9 9K-15 P 425	W01-358-9291	32
910105P883	W01-358-9307	35
91012A319	W01-358-9105	38
91012A329	W01-358-9078	38
91012A341	W01-358-9113	Call us
91012A342	W01-358-9118	38
91012A343	W01-358-9302	Call us
91012A488	W01-358-9366	39
91012A543	W01-358-8203	36
91012P483	W01-358-8201	Call us
91012P485	W01-358-8932	37
91012P487	W01-358-9339	39
910135S881	W01-358-8800	71
91014A490	W01-358-9336	43
91014A491	W01-358-9467	43
91014A492	W01-358-9482	43
91014A546	W01-358-8810	41
91014P335	W01-358-9059	42
91014P344	W01-358-9008	Call us
91014P349	W01-358-9071	42
91014P437	W01-358-9463	Call us
91014P489	W01-358-8803	40
91014P494	W01-358-9484	43
91014P577	W01-358-8813	41

PRIMARY TRUCK & TRAILER, AUXILIARY / TAG AXLE
CONTITECH ASSEMBLY NUMBER TO FIRESTONE

CONTITECH BELLOWS NO.	FIRESTONE AON	PAGE NO.
91014P718	W01-358-9507	44
91014P882	W01-358-9697	44
91014P905	W01-358-8816	41
91014P906	W01-358-8817	41
91016P351	W01-358-9193	47
91016P392	W01-358-9304	49
91016P498	W01-358-8927	46
91016P500	W01-358-9474	50
91016P547	W01-358-9496	50
91016P549	W01-358-9643	64
910175A802	W01-358-1096	45
910175P406	W01-358-9287	53
910175P430	W01-358-9942	52
910175P440	W01-358-9373	53
910175P440	W01-358-9375	54
910175P451	W01-358-9375	54
910175P452	W01-358-9947	52
910175P456	W01-358-9648	73
910175P475	W01-358-9943	52
910175P519	W01-358-9373	53
910175P520	W01-358-9297	53
910175P521	W01-358-9371	53
910175P550	W01-358-9647	54
910175P551	W01-358-9649	54
910175P571	W01-358-9502	70
910175P574	W01-358-9504	70
910175P731	W01-358-9966	50
910175P732	W01-358-9947	52
910175P733	W01-358-9223	48
910175P779	W01-358-6258	71
910175P831	W01-358-6262	62
910175P904	W01-358-8888	50
910185P440	W01-358-9373	53
910185P550	W01-358-9647	54
910185P551	W01-358-9649	54
910185P935	W01-358-9297	53
910185P939	W01-358-9663	55
910195A801	W01-358-0783	55
91019A358	W01-358-9394	59

CONTITECH BELLOWS NO.	FIRESTONE AON	PAGE NO.
91019A830	W01-358-0783	55
91019P359	W01-358-9350	59
91019P383	W01-358-9394	59
91019P391	W01-358-9362	49
91019P553	W01-358-8856	56
91019P762	W01-358-8861	56
91019P765	W01-358-8842	55
91019P801	W01-358-0783	55
91019P898	W01-358-8864	56
91021P361	W01-358-9321	60
91021P505	W01-358-9367	60
910B175A362	W01-358-9274	68
910B175P733	W01-358-9223	48
910BP16P569	W01-358-9644	61
910BP20P738	W01-358-9646	61
910BP22P739	W01-358-9645	61
910D21A555	W01-358-9269	Call us
910S16A382	W01-358-9780	72
9910P861	W01-358-9541	26
9912A334	W01-358-9075	Call us
9912A464	W01-358-8901	20
9914A517	W01-358-8903	63
9914A517	W01-358-8919	23
9916P568	W01-358-9626	25
99515A455	W01-358-8949	32
99515P417	W01-358-9295	33
999P756	W01-358-9651	65
999S537	W01-358-9622	26
999S860	W01-358-9617	25
99B20P740	W01-358-9621	27
99B22P741	W01-358-9619	28
99K15P423	W01-358-9294	32
FD 120-20 509	W01-358-7325	113
FD 12017 3/4 M8	W01-358-7325	113
FD 200-19 310	W01-358-6902	99
FD 200-19 315	W01-358-6905	100
FD 200-19 320	W01-358-6910	100
FD 200-19 362	W01-358-6908	100
FD 200-19 448	W01-358-6941	101

PRIMARY TRUCK & TRAILER, AUXILIARY /TAG AXLE

CONTITECH ASSEMBLY NUMBER TO FIRESTONE

CONTITECH BELLOWS NO.	FIRESTONE AON	PAGE NO.
FD 200-19 450	W01-358-6940	101
FD 200-19 452	W01-358-6932	100
FD 200-19 499	W01-358-6935	101
FD 200-19 504	W01-358-6926	100
FD 200-19 505	W01-358-6897	99
FD 200-19 510	W01-358-7788	102
FD 200-19 713	W01-358-7795	102
FD 200-25 426	W01-358-6943	104
FD 200-25 427	W01-358-6945	104
FD 200-25 428	W01-358-6947	105
FD 200-25 429	W01-358-6948	105
FD 200-25 453	W01-358-6927	104
FD 200-25 454	W01-358-6944	104
FD 200-25 463	W01-358-6946	104
FD 330-22 313	W01-358-7400	109
FD 330-22 318	W01-358-7403	110
FD 330-22 323	W01-358-7443	112
FD 330-22 327	W01-358-7424	111
FD 330-22 331	W01-358-7410	111
FD 330-22 334	W01-358-7401	109
FD 330-22 334	W01-358-7437	111
FD 330-22 343	W01-358-7429	111
FD 330-22 346	W01-358-7404	110
FD 330-22 363	W01-358-7180	108
FD 330-22 364	W01-358-7405	110
FD 330-22 367	W01-358-7409	110
FD 330-22 368	W01-358-7423	111
FD 330-22 471	W01-358-7183	109
FD 330-22 472	W01-358-7181	108
FD 330-22 500	W01-358-7344	109
FD 330-30 340	W01-358-7447	112
FD 330-30 340	W01-358-7790	113
FD 330-30 369	W01-358-7444	112
FD 330-30 370	W01-358-7446	112
FD 330-30 371	W01-358-7472	116
FD 330-30 372	W01-358-7473	112
FD 331-26 480	W01-358-7555	117
FD 331-26 514	W01-358-7545	116
FD 331-26-541	W01-358-7550	117

CONTITECH BELLOWS NO.	FIRESTONE AON	PAGE NO.
FD 530-22 311	W01-358-7135	106
FD 530-22 316	W01-358-7140	106
FD 530-22 321	W01-358-7136	106
FD 530-22 342	W01-358-7146	106
FD 530-22 345	W01-358-7123	105
FD 530-22 374	W01-358-7145	106
FD 530-30 449	W01-358-6803	107
FD 530-30 451	W01-358-6801	107
FD 530-30 532	W01-358-6805	108
FD 530-35 530	W01-358-7557	117
FD 530-35 543	W01-358-6799	117
FD 530-35 544	W01-358-7782	118
FD11017A	W01-358-7659	114
FD12017509	W01-358-7325	113
FD12017A789	W01-358-7505	114
FD12020715	W01-358-7705	114
FD20019319	W01-358-6900	99
FD20019452	W01-358-7686	101
FD20019499	W01-358-6856	98
FD20019506	W01-358-6949	101
FD20019539	W01-358-6890	99
FD20019724	W01-358-6884	99
FD20022524	W01-358-7795	102
FD20022524	W01-358-7897	103
FD20022529	W01-358-6883	102
FD20022706	W01-358-6886	103
FD20023A709	W01-358-7897	103
FD20025507	W01-358-6960	105
FD20025511	W01-358-6962	105
FD33022366	W01-358-7408	110
FD53030518	W01-358-6800	107
FD53030519	W01-358-6808	108
FD53035545	W01-358-7781	118
FD999P767	W01-358-5789	67
FS 330-11 467	W01-358-6994	96
FS 330-11 468	W01-358-7009	96
FS 330-11 474	W01-358-7008	96
FS 530-14 339	W01-358-7112	98
FS 530-14 442	W01-358-7103	97

PRIMARY TRUCK & TRAILER, AUXILIARY / TAG AXLE
CONTITECH ASSEMBLY NUMBER TO FIRESTONE

CONTITECH BELLOWS NO.	FIRESTONE AON	PAGE NO.
FS 530-14 446	W01-358-7104	97
FS53014515	W01-358-7093	97
FS53014538	W01-358-7094	98
FT 330-29 413	W01-358-8032	122
FT 330-29 431	W01-358-8008	120
FT 330-29 431	W01-358-8025	121
FT 330-29 432	W01-358-8010	120
FT 330-29 432	W01-358-8030	121
FT 330-29 434	W01-358-8018	121
FT 330-29 466	W01-358-8027	121
FT 330-29 503	W01-358-8006	120
FT 330-29 520	W01-358-7996	120
FT 330-29 525	W01-358-8033	122
FT 330-29 546	W01-358-7994	119
FT 330-29 547	W01-358-7990	119
FT 330-29 547	W01-358-7995	119
FT 330-29 554	W01-358-8038	127
FT 530-32 325	W01-358-7818	124
FT 530-32 329	W01-358-7798	123
FT 530-32 333	W01-358-7800	123
FT 530-32 336	W01-358-7808	124
FT 530-35 436	W01-358-7838	Call us
FT 530-35 441	W01-358-7850	126
FT 530-35 455	W01-358-7843	125
FT 530-35 456	W01-358-7846	125
FT 530-35 457	W01-358-7847	125
FT 530-35 534	W01-358-7862	126
FT33029433	W01-358-8016	121
FT33029469	W01-358-8025	121
FT33029494	W01-358-8018	121
FT33029498	W01-358-8030	121
FT53032535	W01-358-7797	123
FT53032536	W01-358-7796	123
FT53035437	W01-358-7839	125
FT53035438	W01-358-7844	Call us
FT53035439	W01-358-7848	126
FT53035521	W01-358-7845	125
FT53035726	W01-358-7872	126
SC29-0046	W02-358-7046	130

CONTITECH BELLOWS NO.	FIRESTONE AON	PAGE NO.
SC29-0086	W02-358-7086	130
SC29-O001	W02-358-7001	131
SC29-O001	W02-358-7002	131
SC29-O001	W02-358-7031	135
SC29-W035	W02-358-7035	138
SC29-W075	W02-358-7075	138
SC29-W087	W02-358-7087	138
SC29-Y036	W02-358-7036	143
SC29-Y064	W02-358-7064	142
SC29-Y108	W02-358-7108	142
SC29B092	W02-358-7092	145
SC29B200	W02-358-7200	146
SC29O100	W02-358-7100	132
SC29O201	W02-358-7201	131
SC29W035	W02-358-7061	139
SC29W085	W02-358-7085	136
SC29Y082	W02-358-7082	143
SC31-W206	W02-358-7206	138
SC31-Y205	W02-358-7205	143
SC31-Y215	W02-358-7215	144
SC31B207	W02-358-7215	144
SC31Y215	W02-358-7215	144
SZ 50-11	W02-358-7002	131
SZ 70-5060 P02	W02-358-7055	134
SZ705052	W02-358-7086	130
SZ705060P02	W02-358-7046	130
SZ705067	W02-358-7001	131
SZ707065P02	W02-358-7035	138
SZ707065P02	W02-358-7108	142
SZ707077	W02-358-7075	138
SZ708077	W02-358-7064	142
SZ708077P02	W02-358-7108	142
SZ708082	W02-358-7082	143
SZ709087	W02-358-7092	145

PRIMARY TRUCK & TRAILER, AUXILIARY /TAG AXLE

BELLOWS INDEX BY BELLOWS NUMBER



1T Bellows Number

1T15M6
or
1T15 Series
C013582149

1T spring shown

These tables include 1T and Convoluted bellows numbers.

For 1T Reversible style springs, locate the bellows number, typically molded directly underneath the Firestone logo. For styles with a **single 1T number**, such as 1T15M6 or 1T19L, use the chart below.

For bellows with a 1T Series number, followed by a C01xxxxxx number, use the **1T Bellows Index by C01 Bellows Number** table on page 210.

BELLOWS NUMBER	PAGE NO.
 <p>1T REVERSIBLE SLEEVE</p>	
1T14C1	12-13
1T14C3	13-15
1T14C5	15-16
1T14C6	16-17
1T14C7	17
1T14C8	18
1T14CB1	18-19
1T14CP3	Call us
1T14F2 (Replaced by 1T14C1)	12-13
1T14F4 (Replaced by 1T14C3)	13-15
1T14F8 (Replaced by 1T14C7)	17
1T15A (Replaced by 1T15M0)	33-35
1T15A3 (Replaced by 1T15M2)	36-39
1T15AA3 (Replaced by 1T15LP3)	29-32
1T15AA6 (Replaced by 1T15LP6)	Call us
1T15AB7 (Replaced by 1T15MPW7)	62-63
1T15AE5 (Replaced by 1T15LP5)	32-33
1T15AEZR5	Call us
1T15AF6 (Replaced by 1T15SN6)	64
1T15AG9 (Replaced by 1T15MM9)	61
1T15B (Replaced by 1T15L2)	20-22
1T15B2 (Replaced by 1T15L2 or 1T15S5)	20-22

BELLOWS NUMBER	PAGE NO.
1T15B3 (Replaced by 1T15S6)	Call us
1T15CCR6	19
1T15DR5.5	19
1T15K0 (Replaced by 1T15M0)	33-35
1T15K1 (Replaced by 1T15M6)	45-50
1T15K2 (Replaced by 1T15M9)	55-59
1T15K4 (Replaced by 1T15M4)	40-44
1T15KW(-1) (Replaced by 1T15LA(-1))	25-26
1T15KW0 (Replaced by 1T15LA0)	26
1T15KW1.5 (Replaced by 1T15L1.5)	19-20
1T15L0.5	Call us
1T15L1.5	19-20
1T15L2	20-22
1T15L2.5X (Replaced by 1T15LC2.5)	27
1T15L3	Call us
1T15L4	22-24
1T15L6	25
1T15L8X (Replaced by 1T15M6)	45-50
1T15L9	25
1T15LA(-1)	25-26
1T15LA0	26
1T15LB10	27
1T15LC2.5	27
1T15LC4.5	27-28
1T15LC12	28
1T15LP1	Call us

PRIMARY TRUCK & TRAILER, AUXILIARY / TAG AXLE

BELLOWS INDEX BY BELLOWS NUMBER

BELLOWS NUMBER	PAGE NO.
1T15LP1.5	28
1T15LP2	28
1T15LP3	29-32
1T15LP5	32-33
1T15LP6	Call us
1T15M0	33-35
1T15M0.5	35
1T15M2	36-39
1T15M3 (Replaced by 1T15MT3)	63
1T15M4	40-44
1T15M6	45-50
1T15M7 (Replaced by 1T15M7.5)	50-53
1T15M7.5	50-53
1T15M8 (Replaced by 1T15M7.5)	50-53
1T15M9	55-59
1T15M11	59-60
1T15MA4	60
1T15MBTW6	61
1T15MBTW10	61
1T15MBTW12	61
1T15MJ6	Call us
1T15MLW7	61
1T15MM5 (Replaced by 1T15MW6)	64
1T15MM9	61
1T15MMW8.0	62
1T15MN6	62
1T15MN7 (Replaced by 1T15M7.5)	50-53
1T15MP7	Call us
1T15MPW6	62
1T15MPW7	62-63
1T15MR2	63
1T15MT3	63
1T15MT6	64
1T15MT8	Call us
1T15MT9	Call us
1T15MW6	64
1T15MW10 (Replaced by 1T15MM9)	61
1T15S5	Call us

BELLOWS NUMBER	PAGE NO.
1T15S6 (Replaced by 1T15LP3)	29-32
1T15SN3	Call us
1T15SN6	64
1T15T1	65
1T15T2	Call us
1T15TM1	65-66
1T15TQ1	66-68
1T15TQ5	Call us
1T15V1	68
1T15V3	68
1T15V8	68-70
1T15V11	70
1T15VL9 (Replaced by 1T15M2)	36-39
1T15VLT10.5 (Replaced by 1T17CL9.5)	79
1T15VM3.5 (Replaced by 1T15VP4)	71
1T15VM4 (Replaced by 1T15VP4)	71
1T15VM8	Call us
1T15VMR8	71
1T15VMW8	71
1T15VP4	71
1T15X1 (Replaced by 1T15M7.5)	50-53
1T15XBZR7.5	72
1T15XMR7	72-73
1T15XNR5	73
1T15XR9	73
1T15Y1 (Replaced by 1T15TQ1)	66-68
1T15Y5 (Replaced by 1T15TQ5)	Call us
1T15ZR3 (Replaced by 1T15MT3)	63
1T15ZR6 (Replaced by 1T15XBZR7.5)	72
1T17AZR4.5	Call us
1T17B5	74-75
1T17B7	75
1T17B11	75-76
1T17BB2	76
1T17BM6	76
1T17BP4	Call us

PRIMARY TRUCK & TRAILER, AUXILIARY /TAG AXLE

BELLOWS INDEX BY BELLOWS NUMBER

BELLOWS NUMBER	PAGE NO.
1T17BP17	76
1T17BV3	77
1T17C3	77
1T17C6	77
1T17C6.5	Call us
1T17C8	77-78
1T17CA3	78
1T17CA5	78
1T17CA6	Call us
1T17CA6.5	78-79
1T17CD3	79
1T17CL5	79
1T17CL9.5	79
1T17DCJ8.5	80
1T17GJ6	80
1T19E1 (Replaced by 1T19L7)	81-84
1T19E2 (Replaced by 1T19L11)	85-86
1T19F3 (Replaced by 1T19L3)	80
1T19F5 (Replaced by 1T19L5)	80-81
1T19F7 (Replaced by 1T19L7)	81-84
1T19F9 (Replaced by 1T19L9)	84-85
1T19F11 (Replaced by 1T19L11)	85-86
1T19F12 (Replaced by 1T19L12)	86-87
1T19F14 (Replaced by 1T19L14)	88
1T19F16 (Replaced by 1T19L16)	88
1T19FC5 (Replaced by 1T19LC5)	89
1T19FC6 (Replaced by 1T19LC6)	89
1T19FC8 (Replaced by 1T19LC8)	89
1T19G8	Call us
1T19J1	Call us
1T19J6 (Replaced by 1T19ZK5.7)	90-91
1T19L3	80
1T19L5	80-81
1T19L7	81-84
1T19L9	84-85
1T19L11	85-86
1T19L12	86-87
1T19L14	88

BELLOWS NUMBER	PAGE NO.
1T19L16	88
1T19LB8	88
1T19LB12	89
1T19LC5	89
1T19LC6	89
1T19LC8	89
1T19LC11	Call us
1T19LE8	90
1T19LE12	90
1T19LF7	90
1T19LG8	90
1T19N9	Call us
1T19ZK5.7	90-91
1T19ZK6.7	Call us
1T26D7	91
1T30E1 (Replaced by 1T19L7)	81-84
1T60BA326	Call us
1T66E11.8 (Replaced by 1T66G11.8)	92
1T66G11.8	92
1T66G19.8	Call us
 SINGLE CONVOLUTED	
16	96
19	96-97
19-.75	97
113	97
113-.5	97
113-1	98
113-1x88-1 (Obsolete No replacement)	Call us
116-1	Call us
126	98
150	98

PRIMARY TRUCK & TRAILER, AUXILIARY / TAG AXLE

BELLOWS INDEX BY BELLOWS NUMBER

BELLOWS NUMBER	PAGE NO.
 DOUBLE CONVOLUTED	
20	98-102
20-1	102-103
20-2	103-105
21	105-107
21-2	107-108
22	108-111
22-1.5	112-113
25 (Replaced by 268)	119
26	113-114
28	114
29	115
201	115
203	115
205	115
215	115
218	Call us
224	116
228-1.5	116-117
233-2	117-118
252	Call us
255-1.5 (replaced by 267-1.5)	118
256-2	Call us
257 (replaced by 20)	98-102
257-1 (replaced by 20-1)	102-103
264	118
267-1.5	118
268	119

BELLOWS NUMBER	PAGE NO.
 TRIPLE CONVOLUTED	
38	119-122
39	122
312	122-123
313	123-124
320	124
321	124
323	124
333	125-126
352	126-127
354	127

PRIMARY TRUCK & TRAILER

1T BELLOWS INDEX BY C01 BELLOWS NUMBER



1T Series Number and C01 Number

1T15M6
or
1T15 Series
C013582149

For 1T Reversible style springs, locate the bellows number, typically molded directly underneath the Firestone logo.

For styles with a **1T Series number, followed by a C01 number**, such as C013582149, use the chart below.

For bellows with a single 1T number, such as 1T15M6 or 1T19L, use the **Bellows Index by Bellows Number** table on page 206.

C01 NUMBER	1T SERIES NUMBER	PAGE NO.
C01-358-0007	W01-358-8944	61
C01-358-0018	W01-358-5298	18
C01-358-0018	W01-358-5319	18
C01-358-0018	W01-358-5379	18
C01-358-0018	W01-358-8992	19
C01-358-0018	W01-358-8997	19
C01-358-0018	W01-358-5297	18
C01-358-0054	W01-358-6231	62
C01-358-0054	W01-358-6262	62
C01-358-0082	W01-358-8494	62
C01-358-0093	W01-358-8478	29
C01-358-0093	W01-358-8492	29
C01-358-0093	W01-358-9017	29
C01-358-0093	W01-358-9049	29
C01-358-0093	W01-358-9073	29
C01-358-0093	W01-358-9290	30
C01-358-0093	W01-358-9539	30
C01-358-0093	W01-358-9587	30
C01-358-0093	W01-358-9592	30
C01-358-0093	W01-358-9597	31
C01-358-0093	W01-358-9599	31
C01-358-0093	W01-358-9652	31
C01-358-0093	W01-358-9750	31
C01-358-0093	W01-358-9953	32
C01-358-0093	W01-358-9285	30
C01-358-0093	W01-358-9595	31

C01 NUMBER	1T SERIES NUMBER	PAGE NO.
C01-358-0095	W01-358-8949	32
C01-358-0095	W01-358-9291	32
C01-358-0095	W01-358-9293	32
C01-358-0095	W01-358-9294	32
C01-358-0095	W01-358-9295	33
C01-358-0106	W01-358-8597	28
C01-358-0107	W01-358-8959	28
C01-358-0394	W01-358-8539	80
C01-358-0416	W01-358-8109	77
C01-358-0417	W01-358-8614	78
C01-358-0420	W01-358-8673	76
C01-358-0452	W01-358-9580	79
C01-358-0452	W01-358-9581	79
C01-358-0453	W01-358-8617	79
C01-358-0454	W01-358-8729	76
C01-358-0455	W01-358-8616	77
C01-358-0458	W01-358-8631	74
C01-358-0458	W01-358-8723	74
C01-358-0458	W01-358-8740	74
C01-358-0458	W01-358-8752	74
C01-358-0458	W01-358-8753	74
C01-358-0458	W01-358-8755	75
C01-358-0458	W01-358-8782	75
C01-358-0459	W01-358-8744	75
C01-358-0459	W01-358-8746	75
C01-358-0459	W01-358-8748	76

PRIMARY TRUCK & TRAILER
BELLOWS INDEX BY BELLOWS NUMBER

CO1 NUMBER	1T SERIES NUMBER	PAGE NO.
C01-358-0459	W01-358-8749	76
C01-358-0463	W01-358-8720	75
C01-358-0466	W01-358-8637	77
C01-358-0467	W01-358-8724	76
C01-358-0469	W01-358-8737	77
C01-358-0469	W01-358-8738	77
C01-358-0470	W01-358-8710	79
C01-358-0471	W01-358-8709	78
C01-358-0473	W01-358-8708	78
C01-358-0473	W01-358-8713	78
C01-358-0473	W01-358-8735	79
C01-358-0495	W01-358-9915	88
C01-358-0496	W01-358-5505	87
C01-358-0496	W01-358-5514	87
C01-358-0497	W01-358-9221	83
C01-358-0501	W01-358-8778	81
C01-358-0501	W01-358-8980	82
C01-358-0501	W01-358-9121	82
C01-358-0501	W01-358-9135	82
C01-358-0501	W01-358-9141	82
C01-358-0501	W01-358-9144	82
C01-358-0501	W01-358-9148	83
C01-358-0501	W01-358-9149	83
C01-358-0501	W01-358-9177	83
C01-358-0501	W01-358-9280	83
C01-358-0501	W01-358-9811	84
C01-358-0504	W01-358-9264	88
C01-358-0513	W01-358-5523	90
C01-358-0513	W01-358-8050	91
C01-358-0513	W01-358-8052	91
C01-358-0513	W01-358-8053	91
C01-358-0517	W01-358-8793	90
C01-358-0519	W01-358-8774	90
C01-358-0521	W01-358-9825	90
C01-358-0522	W01-358-5503	86
C01-358-0522	W01-358-5508	87

CO1 NUMBER	1T SERIES NUMBER	PAGE NO.
C01-358-0522	W01-358-5511	87
C01-358-0522	W01-358-9891	87
C01-358-0525	W01-358-8792	85
C01-358-0525	W01-358-9122	85
C01-358-0525	W01-358-9156	85
C01-358-0525	W01-358-9158	86
C01-358-0525	W01-358-9804	86
C01-358-0525	W01-358-9985	86
C01-358-0525	W01-358-8796	85
C01-358-0526	W01-358-8760	80
C01-358-0527	W01-358-9896	88
C01-358-0527	W01-358-9928	88
C01-358-0562	W01-358-5530	90
C01-358-0572	W01-358-9780	72
C01-358-0572	W01-358-9781	72
C01-358-0572	W01-358-9782	72
C01-358-0583 (replaced by C01-358-0572)		72
C01-358-0927	W01-358-8984	92
C01-358-1000	W01-358-0783	55
C01-358-1000	W01-358-8842	55
C01-358-1000	W01-358-8852	56
C01-358-1000	W01-358-8855	56
C01-358-1000	W01-358-8856	56
C01-358-1000	W01-358-8861	56
C01-358-1000	W01-358-8864	56
C01-358-1000	W01-358-9101	57
C01-358-1000	W01-358-9106	57
C01-358-1000	W01-358-9130	57
C01-358-1000	W01-358-9192	57
C01-358-1000	W01-358-9203	57
C01-358-1000	W01-358-9238	58
C01-358-1000	W01-358-9241	58
C01-358-1000	W01-358-9243	58
C01-358-1000	W01-358-9245	58
C01-358-1000	W01-358-9346	59
C01-358-1000	W01-358-9350	59

PRIMARY TRUCK & TRAILER

1T BELLOWS INDEX BY C01 BELLOWS NUMBER

C01 NUMBER	1T SERIES NUMBER	PAGE NO.
C01-358-1000	W01-358-9394	59
C01-358-1000	W01-358-9240	58
C01-358-1000	W01-358-9348	59
C01-358-1008	W01-358-5766	65
C01-358-1008	W01-358-9421	66
C01-358-1008	W01-358-9423	66
C01-358-1013	W01-358-9401	65
C01-358-1013	W01-358-9402	65
C01-358-1013	W01-358-9650	65
C01-358-1013	W01-358-9651	65
C01-358-1016	W01-358-9268	63
C01-358-1030	W01-358-5770	66
C01-358-1030	W01-358-5783	67
C01-358-1030	W01-358-5792	67
C01-358-1031	W01-358-5772	66
C01-358-1031	W01-358-5775	66
C01-358-1031	W01-358-5777	67
C01-358-1031	W01-358-5789	67
C01-358-1039	W01-358-9626	25
C01-358-1048	W01-358-5776	67
C01-358-1048	W01-358-9586	68
C01-358-1069	W01-358-8466	63
C01-358-1069	W01-358-9634	63
C01-358-1069	W01-358-9640	63
C01-358-1078	W01-358-9646	61
C01-358-1079	W01-358-9645	61
C01-358-1081	W01-358-9644	61
C01-358-1131	W01-358-8197	36
C01-358-1131	W01-358-8203	36
C01-358-1131	W01-358-8204	36
C01-358-1131	W01-358-8878	37
C01-358-1131	W01-358-8938	37
C01-358-1131	W01-358-8991	37
C01-358-1131	W01-358-9053	38
C01-358-1131	W01-358-9078	38
C01-358-1131	W01-358-9105	38

C01 NUMBER	1T SERIES NUMBER	PAGE NO.
C01-358-1131	W01-358-9303	38
C01-358-1131	W01-358-9325	39
C01-358-1131	W01-358-9365	39
C01-358-1131	W01-358-9366	39
C01-358-1131	W01-358-9807	39
C01-358-1131	W01-358-8195	36
C01-358-1131	W01-358-8198	36
C01-358-1131	W01-358-8932	37
C01-358-1131	W01-358-9118	38
C01-358-1131	W01-358-9339	39
C01-358-1150	W01-358-8525	19
C01-358-1169	W01-358-8779	84
C01-358-1169	W01-358-8780	84
C01-358-1169	W01-358-8781	84
C01-358-1169	W01-358-9134	84
C01-358-1169	W01-358-9138	85
C01-358-1178	W01-358-9648	73
C01-358-1179	W01-358-8829	72
C01-358-1179	W01-M58-8463	72
C01-358-1179	W01-M58-8468	73
C01-358-1180	W01-358-1190	73
C01-358-1180	W01-358-1191	73
C01-358-1180	W01-358-1192	73
C01-358-2003	W01-358-9547	25
C01-358-2003	W01-358-9617	25
C01-358-2003	W01-358-9622	26
C01-358-2007	W01-358-9618	26
C01-358-2007	W01-358-9625	26
C01-358-2018	W01-358-9621	27
C01-358-2020	W01-358-9584	20
C01-358-2021	W01-358-9541	26
C01-358-2021	W01-358-9675	26
C01-358-2112	W01-358-2119	12
C01-358-2112	W01-358-2120	12
C01-358-2112	W01-358-2131	12
C01-358-2112	W01-358-5310	12

PRIMARY TRUCK & TRAILER
BELLOWS INDEX BY BELLOWS NUMBER

CO1 NUMBER	1T SERIES NUMBER	PAGE NO.
C01-358-2112	W01-358-5311	12
C01-358-2112	W01-358-5323	13
C01-358-2112	W01-358-5343	13
C01-358-2114	W01-358-5335	15
C01-358-2114	W01-358-5336	15
C01-358-2114	W01-358-5345	15
C01-358-2114	W01-358-5354	16
C01-358-2114	W01-358-8868	16
C01-358-2139	W01-358-8961	33
C01-358-2139	W01-358-8964	33
C01-358-2139	W01-358-8971	33
C01-358-2139	W01-358-9031	34
C01-358-2139	W01-358-9033	34
C01-358-2139	W01-358-9036	34
C01-358-2139	W01-358-9308	34
C01-358-2139	W01-358-9334	35
C01-358-2139	W01-358-9333	35
C01-358-2145	W01-358-8802	40
C01-358-2145	W01-358-8803	40
C01-358-2145	W01-358-8805	40
C01-358-2145	W01-358-8806	40
C01-358-2145	W01-358-8810	41
C01-358-2145	W01-358-8813	41
C01-358-2145	W01-358-8816	41
C01-358-2145	W01-358-8817	41
C01-358-2145	W01-358-9010	41
C01-358-2145	W01-358-9056	42
C01-358-2145	W01-358-9059	42
C01-358-2145	W01-358-9069	42
C01-358-2145	W01-358-9070	42
C01-358-2145	W01-358-9071	42
C01-358-2145	W01-358-9335	43
C01-358-2145	W01-358-9336	43
C01-358-2145	W01-358-9482	43
C01-358-2145	W01-358-9484	43
C01-358-2145	W01-358-9507	44

CO1 NUMBER	1T SERIES NUMBER	PAGE NO.
C01-358-2145	W01-358-9697	44
C01-358-2145	W01-358-9797	44
C01-358-2145	W01-358-9978	44
C01-358-2145	W01-358-0742	40
C01-358-2145	W01-358-9467	43
C01-358-2145	W01-358-9585	44
C01-358-2149	W01-358-1096	45
C01-358-2149	W01-358-8824	45
C01-358-2149	W01-358-8924	45
C01-358-2149	W01-358-9026	46
C01-358-2149	W01-358-9082	46
C01-358-2149	W01-358-9083	46
C01-358-2149	W01-358-9092	46
C01-358-2149	W01-358-9093	47
C01-358-2149	W01-358-9096	47
C01-358-2149	W01-358-9194	47
C01-358-2149	W01-358-9210	47
C01-358-2149	W01-358-9213	48
C01-358-2149	W01-358-9219	48
C01-358-2149	W01-358-9223	48
C01-358-2149	W01-358-9227	48
C01-358-2149	W01-358-9296	49
C01-358-2149	W01-358-9304	49
C01-358-2149	W01-358-9362	49
C01-358-2149	W01-358-9392	49
C01-358-2149	W01-358-9466	49
C01-358-2149	W01-358-9474	50
C01-358-2149	W01-358-9966	50
C01-358-2149	W01-358-8591	45
C01-358-2149	W01-358-8825	45
C01-358-2149	W01-358-8927	46
C01-358-2149	W01-358-9193	47
C01-358-2149	W01-358-9211	48
C01-358-2149	W01-358-9496	50
C01-358-2151	W01-358-9039	34
C01-358-2151	W01-358-8963	33

PRIMARY TRUCK & TRAILER

1T BELLOWS INDEX BY C01 BELLOWS NUMBER

C01 NUMBER	1T SERIES NUMBER	PAGE NO.
C01-358-2160	W01-358-9287	53
C01-358-2160	W01-358-9297	53
C01-358-2160	W01-358-9371	53
C01-358-2160	W01-358-9373	53
C01-358-2160	W01-358-9375	54
C01-358-2160	W01-358-9641	54
C01-358-2160	W01-358-9647	54
C01-358-2160	W01-358-9649	54
C01-358-2160	W01-358-9654	54
C01-358-2160	W01-358-9663	55
C01-358-2161	W01-358-9260	64
C01-358-2161	W01-358-9278	64
C01-358-2166	W01-358-9568	28
C01-358-2166	W01-358-9567	27
C01-358-2169	W01-358-8831	64
C01-358-2169	W01-358-9643	64
C01-358-2170	W01-358-9619	28
C01-358-2171	W01-358-9560	25
C01-358-2176	W01-358-8647	22
C01-358-2176	W01-358-8874	23
C01-358-2176	W01-358-8916	23
C01-358-2176	W01-358-8919	23
C01-358-2176	W01-358-8922	23
C01-358-2176	W01-358-8941	23
C01-358-2176	W01-358-9391	24
C01-358-2176	W01-358-9415	24
C01-358-2176	W01-358-9439	24
C01-358-2176	W01-358-9441	24
C01-358-2176	W01-358-9469	24
C01-358-2179	W01-358-9379	27
C01-358-2179	W01-358-9565	27
C01-358-2179	W01-358-9566	27
C01-358-2182	W01-358-8897	20
C01-358-2182	W01-358-8901	20
C01-358-2182	W01-358-9376	20
C01-358-2182	W01-358-9387	21

C01 NUMBER	1T SERIES NUMBER	PAGE NO.
C01-358-2182	W01-358-9445	21
C01-358-2182	W01-358-9447	21
C01-358-2182	W01-358-9448	21
C01-358-2182	W01-358-9457	21
C01-358-2182	W01-358-9459	22
C01-358-2182	W01-358-9477	22
C01-358-2182	W01-358-9562	22
C01-358-2182	W01-358-9551	22
C01-358-2184	W01-358-9422	19
C01-358-2184	W01-358-9616	20
C01-358-2185	W01-358-5405	13
C01-358-2185	W01-358-5406	13
C01-358-2185	W01-358-5410	14
C01-358-2185	W01-358-5412	14
C01-358-2185	W01-358-5414	14
C01-358-2185	W01-358-5422	14
C01-358-2185	W01-358-5423	14
C01-358-2185	W01-358-5434	15
C01-358-2185	W01-358-9478	15
C01-358-2185	W01-358-5408	13
C01-358-2187	W01-358-5426	17
C01-358-2187	W01-358-5702	17
C01-358-2187	W01-358-5712	17
C01-358-2187	W01-358-5710	17
C01-358-2188	W01-358-5429	18
C01-358-2190	W01-358-9307	35
C01-358-2192	W01-358-5439	16
C01-358-2192	W01-358-5730	16
C01-358-2192	W01-358-8977	16
C01-358-2192	W01-358-8979	17
C01-358-2193	W01-358-8970	35
C01-358-2193	W01-358-9306	35
C01-358-2197	W01-358-8888	50
C01-358-2197	W01-358-9342	50
C01-358-2197	W01-358-9902	51
C01-358-2197	W01-358-9921	51

PRIMARY TRUCK & TRAILER
BELLOWS INDEX BY BELLOWS NUMBER

CO1 NUMBER	1T SERIES NUMBER	PAGE NO.
C01-358-2197	W01-358-9922	51
C01-358-2197	W01-358-9923	51
C01-358-2197	W01-358-9935	51
C01-358-2197	W01-358-9936	52
C01-358-2197	W01-358-9947	52
C01-358-2197	W01-358-9971	52
C01-358-2197	W01-358-9974	53
C01-358-2197	W01-358-9943	52
C01-358-2200	W01-358-8828	62
C01-358-2203	W01-358-9265	61
C01-358-2205	W01-358-9299	64
C01-358-2211	W01-358-9749	25
C01-358-2276	W01-358-8184	19
C01-358-5085	W01-358-9865	71
C01-358-5085	W01-358-9866	71
C01-358-5087	W01-358-6258	71
C01-358-5090	W01-358-8800	71
C01-358-5090	W01-358-9270	71
C01-358-5098	W01-358-9578	68
C01-358-5098	W01-358-9582	68
C01-358-5103	W01-358-9249	68
C01-358-5105	W01-358-9274	68
C01-358-5105	W01-358-9275	69
C01-358-5105	W01-358-9470	69
C01-358-5105	W01-358-9471	69
C01-358-5105	W01-358-9472	69
C01-358-5105	W01-358-9473	69
C01-358-5105	W01-358-9491	70
C01-358-5105	W01-358-9501	70
C01-358-5105	W01-358-9504	70
C01-358-5105	W01-358-9502	70
C01-358-5129	W01-358-9320	59
C01-358-5129	W01-358-9321	60
C01-358-5129	W01-358-9367	60
C01-358-5129	W01-358-9370	60
C01-358-5129	W01-358-9368	60

CO1 NUMBER	1T SERIES NUMBER	PAGE NO.
C01-358-5133	W01-358-9250	70
C01-358-5147	W01-358-9310	91
C01-358-5147	W01-358-9327	91
C01-358-5250	W01-358-8092	89
C01-358-5349	W01-358-8091	89
C01-358-5350	W01-358-8093	89
C01-358-5356	W01-358-8500	80
C01-358-5356	W01-358-9200	80
C01-358-5356	W01-358-9206	81
C01-358-5356	W01-358-9215	81
C01-358-5356	W01-358-9218	81
C01-358-5356	W01-358-9801	81
C01-M58-0020	W01-358-8931	37
C01-M58-0032	W01-358-8903	63
C01-M58-0032	W01-M58-7074	62
C01-M58-0475	W01-M58-8712	78
C01-M58-0492	W01-M58-8775	88
C01-M58-0499	W01-M58-6339	86
C01-M58-1163	W01-M58-6348	89
C01-M58-2123	W01-M58-9372	55
C01-M58-2123	W01-M58-9656	55
C01-M58-2197	W01-358-9942	52
C01-M58-2212	W01-358-9554	28
C01-M58-2217	W01-M58-8608	80
C01-M58-2292	W01-M58-9851	60
C01-M58-5346	W01-M58-8798	89

PRIMARY TRUCK & TRAILER, AUXILIARY /TAG AXLE

BELLOWS INDEX BY SIZE

BELLOWS NUMBER	PAGE NO.
 <p>1T REVERSIBLE SLEEVE</p>	
5.31" DIA. BEAD PLATE / 6.60" MOLDED DIA.	
1T26D7	91
6.31" DIA. BEAD PLATE / 6.62" MOLDED DIA.	
1T14C1	12-13
1T14C3	13-15
1T14C5	15-16
1T14C6	16-17
1T14C7	17
1T14C8	18
1T14CB1	18-19
9.00" DIA. BEAD PLATE / 7.37" MOLDED DIA.	
1T15DR5.5	19
9.00" DIA. BEAD PLATE / 7.75" MOLDED DIA.	
1T15SN6	64
1T15T1	65
1T15TM1	65-66
1T15TQ1	66-68
9.00" DIA. BEAD PLATE / 9.12" MOLDED DIA.	
1T15CCR6	19
1T15L1.5	19-20
1T15L2	20-22
1T15L4	22-24
1T15L6	25
1T15L9	25
1T15LA(-1)	25-26
1T15LA0	26
1T15LB10	27
1T15LC2.5	27
1T15LC4.5	27-28

BELLOWS NUMBER	PAGE NO.
1T15LC12	28
1T15LP1.5	28
1T15LP2	28
1T15LP3	29-32
1T15LP5	32-33
1T15LP2	29
1T15LP3	30-32
1T15LP5	33
9.00" DIA. BEAD PLATE / 10.00" MOLDED DIA.	
1T15XR9	73
9.00" DIA. BEAD PLATE / 10.12" MOLDED DIA.	
1T15M0	33-35
1T15M0.5	35
1T15M2	36-39
1T15M4	40-44
1T15M6	45-50
1T15M7.5	50-53
1T15M8	53-55
1T15M9	55-59
1T15M11	59-60
1T15MA4	60
1T15MBTW6	61
1T15MBTW10	61
1T15MBTW12	61
1T15MLW7	61
1T15MM9	61
1T15MMW8.0	62
1T15MN6	62
1T15MPW6	62
1T15MPW7	62-63
1T15MR2	63
1T15MT3	63
1T15MT6	64

PRIMARY TRUCK & TRAILER, AUXILIARY / TAG AXLE

BELLOWS INDEX BY SIZE

BELLOWS NUMBER	PAGE NO.
1T15MW6	64
1T15V1	68
1T15V3	68
1T15V8	68-70
1T15V11	70
1T15VMR8	71
1T15VMW8	71
1T15VP4	71
1T15XMR7	72-73
1T15XNR5	73
9.00" DIA. BEAD PLATE / 10.62" MOLDED DIA.	
1T15XBZR7.5	72
10.12" DIA. BEAD PLATE / 6.60" MOLDED DIA.	
1T17B5	74-75
1T17B7	75
1T17B11	75-76
1T17BB2	76
1T17BM6	76
1T17BP17	76
1T17BV3	77
1T17CA3	78
1T17CL5	79
10.38" DIA. BEAD PLATE / 10.62" MOLDED DIA.	
1T17C3	77
1T17C6	77
1T17C8	77-78
1T17CA5	78
1T17CA6.5	78-79
1T17CD3	79
1T17CL9.5	79
10.38" DIA. BEAD PLATE / 11.41" MOLDED DIA.	
1T17DCJ8.5	80
10.38" DIA. BEAD PLATE / 13.90" MOLDED DIA.	
1T17GJ6	80

BELLOWS NUMBER	PAGE NO.
11.31" DIA. BEAD PLATE / 10.62" MOLDED DIA.	
1T19L3	80
1T19L5	80-81
1T19L7	81-84
1T19L9	84-85
1T19L11	85-86
1T19L12	86-87
1T19L14	88
1T19L16	88
1T19LB8	88
1T19LB12	89
1T19LC5	89
1T19LC6	89
1T19LC8	89
1T19LE8	90
1T19LE12	90
1T19LF7	90
1T19ZK5.7	90-91
1T66G11.8	92
1T19ZK5.7	94-95
1T66G11.8	95



CONVOLUTED
ON NEXT PAGE

PRIMARY TRUCK & TRAILER, AUXILIARY /TAG AXLE

BELLOWS INDEX BY SIZE

BELLOWS NUMBER	PAGE NO.
 SINGLE CONVOLUTED	
4.50" DIA. BEAD PLATE / 5.23" MOLDED DIA.	
16	96
6.31" DIA. BEAD PLATE / 8.88" MOLDED DIA.	
150	98
9.00" DIA. BEAD PLATE / 12.00" MOLDED DIA.	
19	96-97
11.31" DIA. BEAD PLATE / 14.12" MOLDED DIA.	
113	97
113-.5	97
113-1	98
19.00" DIA. BEAD PLATE / 21.50" MOLDED DIA.	
126	98
 DOUBLE CONVOLUTED	
4.50" DIA. BEAD PLATE / 5.75" MOLDED DIA.	
268	119
267-1.5	118
5.31" DIA. BEAD PLATE / 7.00" MOLDED DIA.	
264	118
5.31" DIA. BEAD PLATE / 7.25" MOLDED DIA.	
224	116
5.31" DIA. BEAD PLATE / 7.44" MOLDED DIA.	
26	113-114
6.31" DIA. BEAD PLATE / 8.88" MOLDED DIA.	
20	98-102
9.00" DIA. BEAD PLATE / 12.00" MOLDED DIA.	
22	108-111
22-1.5	112-113
228-1.5	116-117

BELLOWS NUMBER	PAGE NO.
11.31" DIA. BEAD PLATE / 14.50" MOLDED DIA.	
21	105-107
205	115
233-2	117-118
13.79" DIA. BEAD PLATE / 16.00" MOLDED DIA.	
28	114
15.13" DIA. BEAD RING / 16.00" MOLDED DIA.	
201	115
16.50" DIA. BEAD PLATE / 19.50" MOLDED DIA.	
203	115
19.00" DIA. BEAD PLATE / 21.50" MOLDED DIA.	
29	115
25.13" DIA. BEAD RING / 26.30" MOLDED DIA.	
215	115
 TRIPLE CONVOLUTED	
9.00" DIA. BEAD PLATE / 11.70" MOLDED DIA.	
38	119-122
354	127
10.38" DIA. BEAD PLATE / 11.70" MOLDED DIA.	
352	126-127
11.31" DIA. BEAD PLATE / 14.50" MOLDED DIA.	
313	123-124
333	125-126
13.79" DIA. BEAD PLATE / 16.00" MOLDED DIA.	
312	122
15.13" DIA. BEAD RING / 16.00" MOLDED DIA.	
312	122
16.50" DIA. BEAD PLATE / 19.50" MOLDED DIA.	
323	124
19.00" DIA. BEAD PLATE / 21.50" MOLDED DIA.	
320	124
25.13" DIA. BEAD RING / 27.90" MOLDED DIA.	
321	124

PRIMARY TRUCK & TRAILER

INDEX BY PISTON COMPONENT NUMBER

PISTON COMP NO.	PISTON DRAWING NO.	PISTON TYPE	PISTON MATERIALS	PISTON AON	FIRESTONE AON	PAGE NO.
3808	NAD-17160	1T19E1	Aluminum	N/A	W01-M58-8775	88
3808	NAD-37989	1T19E1	Aluminum	N/A	W01-M58-8775	88
3808	NAD-40208	1T19E1	Aluminum	N/A	W01-M58-8775	88
3822	NBD-10378	1T15M2	Aluminum	N/A	W01-358-8931	37
3822	NBD-10378	1T15M2	Aluminum	N/A	W01-358-9391	24
3850	NAD-28198	1T15MP6	Composite	N/A	W01-M58-7074	62
3850	NAD-28198	1T15MP6	Composite	N/A	W01-M58-8608	80
3881	NAD-34837	1T15MP6	Composite	N/A	W01-M58-7074	62
3881	NAD-34837	1T15MP6	Composite	N/A	W01-M58-8608	80
3894	NAD-34318	1T19G5	Aluminum	N/A	W01-M58-8798	89
4008	FIP-101526	1T15MR	Composite	N/A	W01-358-1190	73
4008	FIP-101526	1T15MR	Composite	N/A	W01-358-1191	73
4008	FIP-101526	1T15MR	Composite	N/A	W01-358-1192	73
4008	FIP-101526	1T15MR	Composite	N/A	W01-358-8829	72
4008	FIP-101526	1T15MR	Composite	N/A	W01-358-9648	73
4008	FIP-101526	1T15MR	Composite	N/A	W01-M58-8463	72
4008	FIP-101526	1T15MR	Composite	N/A	W01-M58-8468	73
4034	NAD-37991	1T19E2	Steel	N/A	W01-M58-6348	89
4078	NBD-17119	1T15Y1	Aluminum	N/A	W01-358-5770	66
4078	NBD-17119	1T15Y1	Aluminum	N/A	W01-358-5772	66
4078	NBD-17119	1T15Y1	Aluminum	N/A	W01-358-5775	66
4078	NBD-17119	1T15Y1	Aluminum	N/A	W01-358-5776	67
4078	NBD-17119	1T15Y1	Aluminum	N/A	W01-358-5777	67
4078	NBD-17119	1T15Y1	Aluminum	N/A	W01-358-5783	67
4078	NBD-17119	1T15Y1	Aluminum	N/A	W01-358-5789	67
4078	NBD-17119	1T15Y1	Aluminum	N/A	W01-358-9586	68
4083	NAD-39687	1T15V11	Aluminum	WC1-358-1607	W01-358-9580	79
4083	NAD-39687	1T15V11	Aluminum	WC1-358-1607	W01-358-9581	79
6781	NAD-40125	1T15MP6	Composite	N/A	W01-M58-7074	62
6781	NAD-40125	1T15M	Composite	N/A	W01-M58-7074	62
6836	FIP-103972	1T15M4	Composite	WC1-358-0666	W01-358-9069	42
6845	FIP-103902	1T17B7	Aluminum	WC1-358-1611	W01-358-8710	79
6846	FIP-103901	1T19G9	Aluminum	N/A	W01-358-8793	90
6846	FIP-103901	1T19G9	Aluminum	N/A	W01-358-9825	90
6848	FIP-103899	1T19G5	Aluminum	WC1-358-0631	W01-358-5530	90
6848	FIP-103899	1T19G5	Aluminum	WC1-358-0631	W01-358-8500	80
6848	FIP-103899	1T19G5	Aluminum	WC1-358-0631	W01-358-8760	80
6848	FIP-103899	1T19G5	Aluminum	WC1-358-0631	W01-358-9200	80
6848	FIP-103899	1T19G5	Aluminum	WC1-358-0631	W01-358-9206	81
6848	FIP-103899	1T19G5	Aluminum	WC1-358-0631	W01-358-9215	81

PRIMARY TRUCK & TRAILER
INDEX BY PISTON COMPONENT NUMBER

PISTON COMP NO.	PISTON DRAWING NO.	PISTON TYPE	PISTON MATERIALS	PISTON AON	FIRESTONE AON	PAGE NO.
6848	FIP-103899	1T19G5	Aluminum	WC1-358-0631	W01-358-9218	81
6848	FIP-103899	1T19G5	Aluminum	WC1-358-0631	W01-358-9801	81
6848	FIP-103899	1T19G5	Aluminum	WC1-358-0631	W01-358-9811	84
6848	FIP-103899	1T19G5	Aluminum	WC1-358-0631	W01-358-9200	80
6849	FIP-103898	1T15M6	Aluminum	N/A	W01-358-9971	52
6849	FIP-103898	1T15M6	Aluminum	N/A	W01-358-9974	53
6850	FIP-103897	1T15M2	Aluminum	N/A	W01-358-9391	24
6850	NBD-10378	1T15M2	Aluminum	N/A	W01-358-9391	24
6851	FIP-103896	1T15M0	Aluminum	WC1-358-0663	W01-358-9031	34
6851	FIP-103896	1T15M0	Aluminum	WC1-358-0663	W01-358-9036	34
6851	FIP-103896	1T15M0	Aluminum	WC1-358-0663	W01-358-9308	34
6851	FIP-103896	1T15M0	Aluminum	WC1-358-0663	W01-358-9334	35
6851	FIP-103896	1T15M0	Aluminum	WC1-358-0663	W01-358-9650	65
6851	FIP-103897	1T15M3	Aluminum	N/A	W01-358-9391	24
6853	FIP-103894	1T14C1	Aluminum	WC1-358-0600	W01-358-5310	12
6853	FIP-103894	1T14C1	Aluminum	WC1-358-0600	W01-358-5311	12
6853	FIP-103894	1T14C1	Aluminum	WC1-358-0600	W01-358-5323	13
6853	FIP-103894	1T14C1	Aluminum	WC1-358-0600	W01-358-5405	13
6853	FIP-103894	1T14C1	Aluminum	WC1-358-0600	W01-358-5406	13
6853	FIP-103894	1T14C1	Aluminum	WC1-358-0600	W01-358-5408	13
6853	FIP-103894	1T14C1	Aluminum	WC1-358-0600	W01-358-5422	14
6853	FIP-103894	1T14C1	Aluminum	WC1-358-0600	W01-358-5434	15
6853	FIP-103894	1T14C1	Aluminum	WC1-358-0600	W01-358-5712	17
6853	NBD-8626	1T14C1	Aluminum	WC1-358-0600	W01-358-5405	13
6853	NBD-8626	1T14C1	Aluminum	WC1-358-0600	W01-358-5408	13
9461	FIP-101678	1T66	Steel	N/A	W01-358-8984	92
9462	FIP-101776	1T15V7	Composite	N/A	W01-358-9274	68
9462	FIP-101776	1T15V7	Composite	N/A	W01-358-9275	69
9462	FIP-101776	1T15V7	Composite	N/A	W01-358-9467	43
9476	NAD-39639	1T15V11	Aluminum	N/A	W01-M58-8712	78
9477	NAD-39638	1T15V11	Aluminum	WC1-358-1607	W01-358-9580	79
9477	NAD-39638	1T15V11	Aluminum	WC1-358-1607	W01-358-9581	79
9478	FIP-103594	1T15M6	Aluminum	WC1-358-1610	W01-358-8755	75
9482	NAD-36702	1T19E1	Aluminum	WC1-358-9450	W01-358-9135	82
9484	FIP-101468	1T15M6	Composite	WC1-358-1674	W01-358-9978	44
9485	FIP-101705	1T15MR8	Composite	N/A	W01-358-9865	71
9485	FIP-101705	1T15MR8	Composite	N/A	W01-358-9866	71
9488	FIP-101115	1T17C8	Composite	N/A	W01-358-8109	77
9489	FIP-101211	1T15	Composite	WC1-358-1660	W01-358-9807	39
9489	FIP-101361	1T15	Composite	WC1-358-1660	W01-358-9807	39

PRIMARY TRUCK & TRAILER

INDEX BY PISTON COMPONENT NUMBER

PISTON COMP NO.	PISTON DRAWING NO.	PISTON TYPE	PISTON MATERIALS	PISTON AON	FIRESTONE AON	PAGE NO.
9490	FIP-101012	1T15M2	Composite	N/A	W01-358-8195	36
9490	FIP-101012	1T15M2	Composite	N/A	W01-358-9469	24
9491	FIP-100744	1T14C1	Composite	N/A	W01-358-2119	12
9491	FIP-100744	1T14C1	Composite	N/A	W01-358-2131	12
9491	FIP-100744	1T14C1	Composite	N/A	W01-358-5297	18
9491	FIP-100744	1T14C1	Composite	N/A	W01-358-5379	18
9491	FIP-100744	1T14C1	Composite	N/A	W01-358-8992	19
9491	FIP-100744	1T14C1	Composite	N/A	W01-358-8997	19
9492	FIP-100742	1T15T0	Composite	N/A	W01-358-5766	65
9492	FIP-100742	1T15T0	Composite	N/A	W01-358-5792	67
9492	FIP-100742	1T15T0	Composite	N/A	W01-358-9401	65
9492	FIP-100742	1T15T0	Composite	N/A	W01-358-9402	65
9492	FIP-100742	1T15T0	Composite	N/A	W01-358-9421	66
9493	FIP-100743	1T14C1	Composite	N/A	W01-358-5298	18
9493	FIP-100743	1T14C1	Composite	N/A	W01-358-5319	18
9493	FIP-100743	1T14C1	Composite	N/A	W01-358-5730	16
9493	FIP-100743	1T14C1	Composite	N/A	W01-358-9478	15
9500	NAD-17855	(replaced by 9544)				
9503	NAD-29826	(replaced by 9544)				
9505	NBD-14537	(replaced by 9492)				
9507	NAD-31763	1T15MP6	Composite	N/A	W01-358-6231	62
9508	NBD-10441	(replaced by 9493)				
9515	NAD-19027	(replaced by 9535)				
9516	NAD-19477	(replaced by 9530)				
9519	NAD-19774	(replaced by 9532)				
9522	NAD-25610	(replaced by 9560)				
9523	NAD-25614	(replaced by 9561)				
9525	NAD-26906	1T17B6	Composite	WC1-358-1609	W01-358-8709	78
9527	NAD-27265	1T15ZR6	Composite	WC1-358-1627	W01-358-9780	72
9528	NAD-29551	1T15V1	Composite	WC1-358-0667	W01-358-8737	77
9528	NBD-14404	1T15V1	Composite	WC1-358-0667	W01-358-8737	77
9528	NBD-14404	1T15V1	Composite	WC1-358-0667	W01-358-8738	77
9528	NBD-14404	1T15V1	Composite	WC1-358-0667	W01-358-8991	37
9528	NBD-14404	1T15V1	Composite	WC1-358-0667	W01-358-9249	68
9528	NBD-14404	1T15V1	Composite	WC1-358-0667	W01-358-9578	68
9528	NBD-14404	1T15V1	Composite	WC1-358-0667	W01-358-9582	68
9530	NAD-27809	1T15M6	Composite	WC1-358-9452	W01-358-0783	55
9530	NAD-27809	1T15M6	Composite	WC1-358-9452	W01-358-8824	45
9530	NAD-27809	1T15M6	Composite	WC1-358-9452	W01-358-8825	45
9530	NAD-27809	1T15M6	Composite	WC1-358-9452	W01-358-8855	56

PRIMARY TRUCK & TRAILER
INDEX BY PISTON COMPONENT NUMBER

PISTON COMP NO.	PISTON DRAWING NO.	PISTON TYPE	PISTON MATERIALS	PISTON AON	FIRESTONE AON	PAGE NO.
9530	NAD-27809	1T15M6	Composite	WC1-358-9452	W01-358-8861	56
9530	NAD-27809	1T15M6	Composite	WC1-358-9452	W01-358-8888	50
9530	NAD-27809	1T15M6	Composite	WC1-358-9452	W01-358-8924	45
9530	NAD-27809	1T15M6	Composite	WC1-358-9452	W01-358-8932	37
9530	NAD-27809	1T15M6	Composite	WC1-358-9452	W01-358-9082	46
9530	NAD-27809	1T15M6	Composite	WC1-358-9452	W01-358-9083	46
9530	NAD-27809	1T15M6	Composite	WC1-358-9452	W01-358-9092	46
9530	NAD-27809	1T15M6	Composite	WC1-358-9452	W01-358-9096	47
9530	NAD-27809	1T15M6	Composite	WC1-358-9452	W01-358-9192	57
9530	NAD-27809	1T15M6	Composite	WC1-358-9452	W01-358-9193	47
9530	NAD-27809	1T15M6	Composite	WC1-358-9452	W01-358-9203	57
9530	NAD-27809	1T15M6	Composite	WC1-358-9452	W01-358-9227	48
9530	NAD-27809	1T15M6	Composite	WC1-358-9452	W01-358-9245	58
9530	NAD-27809	1T15M6	Composite	WC1-358-9452	W01-358-9342	50
9530	NAD-27809	1T15M6	Composite	WC1-358-9452	W01-358-9502	70
9530	NAD-27809	1T15M6	Composite	WC1-358-9452	W01-358-9560	25
9531	NAD-29827	1T15MP6	Composite	N/A	W01-358-8864	56
9532	NAD-29827	1T15M6	Composite	WC1-358-1619	W01-358-8494	62
9532	NAD-29827	1T15M6	Composite	WC1-358-1619	W01-358-8746	75
9532	NAD-29827	1T15M6	Composite	WC1-358-1619	W01-358-8748	76
9532	NAD-29827	1T15M6	Composite	WC1-358-1619	W01-358-8803	40
9532	NAD-29827	1T15M6	Composite	WC1-358-1619	W01-358-8842	55
9532	NAD-29827	1T15M6	Composite	WC1-358-1619	W01-358-8852	56
9532	NAD-29827	1T15M6	Composite	WC1-358-1619	W01-358-8856	56
9532	NAD-29827	1T15M6	Composite	WC1-358-1619	W01-358-8903	63
9532	NAD-29827	1T15M6	Composite	WC1-358-1619	W01-358-9026	46
9532	NAD-29827	1T15M6	Composite	WC1-358-1619	W01-358-9194	47
9532	NAD-29827	1T15M6	Composite	WC1-358-1619	W01-358-9243	58
9532	NAD-29827	1T15M6	Composite	WC1-358-1619	W01-358-9295	33
9532	NAD-29827	1T15M6	Composite	WC1-358-1619	W01-358-9325	39
9532	NAD-29827	1T15M6	Composite	WC1-358-1619	W01-358-9362	49
9532	NAD-29827	1T15M6	Composite	WC1-358-1619	W01-358-9470	69
9532	NAD-29827	1T15M6	Composite	WC1-358-1619	W01-358-9496	50
9532	NAD-29827	1T15M6	Composite	WC1-358-1619	W01-358-9621	27
9532	NAD-29827	1T15M6	Composite	WC1-358-1619	W01-358-9626	25
9532	NAD-29827	1T15M6	Composite	WC1-358-1619	W01-358-9644	61
9532	NAD-29827	1T15M6	Composite	WC1-358-1619	W01-358-9646	61
9532	NAD-29827	1T15M6	Composite	WC1-358-1619	W01-358-9697	44
9532	NAD-29827	1T15M6	Composite	WC1-358-1619	W01-358-9923	51
9532	NAD-29827	1T15M6	Composite	WC1-358-1619	W01-358-9935	51

PRIMARY TRUCK & TRAILER

INDEX BY PISTON COMPONENT NUMBER

PISTON COMP NO.	PISTON DRAWING NO.	PISTON TYPE	PISTON MATERIALS	PISTON AON	FIRESTONE AON	PAGE NO.
9532	NAD-29827	1T15M6	Composite	WC1-358-1619	W01-358-9942	52
9533	NAD-30515	1T17BB2	Composite	N/A	W01-358-8617	79
9533	NAD-30515	1T17BB2	Composite	N/A	W01-358-8729	76
9535	NAD-29592	1T15S6	Composite	N/A	W01-358-9260	64
9535	NAD-29592	1T15S6	Composite	N/A	W01-358-9278	64
9537	NAD-29798	1T17B7	Composite	WC1-358-1637	W01-358-8708	78
9537	NAD-29798	1T17B7	Composite	WC1-358-1637	W01-358-8713	78
9538	NAD-27740	1T15M6	Composite	WC1-358-1628	W01-358-8591	45
9538	NAD-27740	1T15M6	Composite	WC1-358-1628	W01-358-9297	53
9538	NAD-27740	1T15M6	Composite	WC1-358-1628	W01-358-9373	53
9538	NAD-27740	1T15M6	Composite	WC1-358-1628	W01-358-9375	54
9538	NAD-27740	1T15M6	Composite	WC1-358-1628	W01-358-9641	54
9538	NAD-27740	1T15M6	Composite	WC1-358-1628	W01-358-9643	64
9538	NAD-27740	1T15M6	Composite	WC1-358-1628	W01-358-9643	64
9538	NAD-27740	1T15M6	Composite	WC1-358-1628	W01-358-9647	54
9538	NAD-27740	1T15M6	Composite	WC1-358-1628	W01-M58-9372	55
9538	NAD-27740	1T15M6	Composite	WC1-358-1628	W01-M58-9656	55
9538	NAD-27740	1T15M6	Composite	WC1-358-1628/ WC1-358-3715	W01-358-9654	54
9538	NAD-27740	1T15M6	Composite	WC1-358-1628/ WC1-358-3715	W01-358-9663	55
9538	NBD-15201	1T15M6	Composite	WC1-358-1628/ WC1-358-3715	W01-358-9654	54
9538	NBD-15201	1T15M6	Composite	WC1-358-1628/ WC1-358-3715	W01-358-9663	55
9540	NAD-29828	1T15M9	Composite	WC1-358-0664	W01-358-8744	75
9540	NAD-29828	1T15M9	Composite	WC1-358-0664	W01-358-8749	76
9540	NAD-29828	1T15M9	Composite	WC1-358-0664	W01-358-9291	32
9540	NAD-29828	1T15M9	Composite	WC1-358-0664	W01-358-9304	49
9540	NAD-29828	1T15M9	Composite	WC1-358-0664	W01-358-9346	59
9540	NAD-29828	1T15M9	Composite	WC1-358-0664	W01-358-9370	60
9540	NAD-29828	1T15M9	Composite	WC1-358-0664	W01-358-9471	69
9540	NAD-29828	1T15M9	Composite	WC1-358-0664	W01-358-9473	69
9540	NAD-29828	1T15M9	Composite	WC1-358-0664	W01-358-9619	28
9540	NAD-29828	1T15M9	Composite	WC1-358-0664	W01-358-9645	61
9540	NAD-29828	1T15M9	Composite	WC1-358-0664	W01-358-9922	51
9540	NAD-29828	1T15M9	Composite	WC1-358-0664	W01-358-9943	52
9541	NAD-25608	(replaced by 9540)				
9544	NAD-29826	1T15M4	Composite	WC1-358-0666	W01-358-8813	41
9544	NAD-29826	1T15M4	Composite	WC1-358-0666	W01-358-8927	46
9544	NAD-29826	1T15M4	Composite	WC1-358-0666	W01-358-9069	42

PRIMARY TRUCK & TRAILER
INDEX BY PISTON COMPONENT NUMBER

PISTON COMP NO.	PISTON DRAWING NO.	PISTON TYPE	PISTON MATERIALS	PISTON AON	FIRESTONE AON	PAGE NO.
9544	NAD-29826	1T15M4	Composite	WC1-358-0666	W01-358-9293	32
9544	NAD-29826	1T15M4	Composite	WC1-358-0666	W01-358-9365	39
9544	NAD-29826	1T15M4	Composite	WC1-358-0666	W01-358-9472	69
9544	NAD-29826	1T15M4	Composite	WC1-358-0666	W01-358-9484	43
9544	NAD-29826	1T15M4	Composite	WC1-358-0666	W01-358-9902	51
9544	NAD-29826	1T15M4	Composite	WC1-358-0666	W01-358-9921	51
9544	NAD-29826	1T15M4	Composite	WC1-358-0666	W01-358-9936	52
9544	NAD-29826	1T15M4	Composite	WC1-358-0666	W01-358-9947	52
9545	NAD-26205	(replaced by 9549)				
9546	NAD-26204	(replaced by 9550)				
9549	NAD-29454	1T15M2	Composite	WC1-358-1616	W01-358-8203	36
9549	NAD-29454	1T15M2	Composite	WC1-358-1616	W01-358-8492	29
9549	NAD-29454	1T15M2	Composite	WC1-358-1616	W01-358-8647	22
9549	NAD-29454	1T15M2	Composite	WC1-358-1616	W01-358-8802	40
9549	NAD-29454	1T15M2	Composite	WC1-358-1616	W01-358-8874	23
9549	NAD-29454	1T15M2	Composite	WC1-358-1616	W01-358-8901	20
9549	NAD-29454	1T15M2	Composite	WC1-358-1616	W01-358-8919	23
9549	NAD-29454	1T15M2	Composite	WC1-358-1616	W01-358-8949	32
9549	NAD-29454	1T15M2	Composite	WC1-358-1616	W01-358-8959	28
9549	NAD-29454	1T15M2	Composite	WC1-358-1616	W01-358-9336	43
9549	NAD-29454	1T15M2	Composite	WC1-358-1616	W01-358-9366	39
9549	NAD-29454	1T15M2	Composite	WC1-358-1616	W01-358-9482	43
9549	NAD-29454	1T15M2	Composite	WC1-358-1616	W01-358-9585	44
9550	NAD-29456	1T15M2	Composite	WC1-358-1652	W01-358-8198	36
9550	NAD-29456	1T15M2	Composite	WC1-358-1652	W01-358-8466	63
9550	NAD-29456	1T15M2	Composite	WC1-358-1652	W01-358-8616	77
9550	NAD-29456	1T15M2	Composite	WC1-358-1652	W01-358-8878	37
9550	NAD-29456	1T15M2	Composite	WC1-358-1652	W01-358-9105	38
9550	NAD-29456	1T15M2	Composite	WC1-358-1652	W01-358-9303	38
9550	NAD-29456	1T15M2	Composite	WC1-358-1652	W01-358-9634	63
9553	NAD-29467	1T15M9	Composite	WC1-358-9453	W01-358-9093	47
9553	NAD-29467	1T15M9	Composite	WC1-358-9453	W01-358-9101	57
9553	NAD-29467	1T15M9	Composite	WC1-358-9453	W01-358-9130	57
9553	NAD-29467	1T15M9	Composite	WC1-358-9453	W01-358-9238	58
9553	NAD-29467	1T15M9	Composite	WC1-358-9453	W01-358-9240	58
9553	NAD-29467	1T15M9	Composite	WC1-358-9453	W01-358-9241	58
9553	NAD-29467	1T15M9	Composite	WC1-358-9453	W01-358-9320	59
9553	NAD-29467	1T15M9	Composite	WC1-358-9453	W01-358-9348	59
9553	NAD-29467	1T15M9	Composite	WC1-358-9453	W01-358-9350	59
9553	NAD-29467	1T15M9	Composite	WC1-358-9453	W01-358-9368	60

CROSS REFERENCES

PRIMARY TRUCK & TRAILER

INDEX BY PISTON COMPONENT NUMBER

PISTON COMP NO.	PISTON DRAWING NO.	PISTON TYPE	PISTON MATERIALS	PISTON AON	FIRESTONE AON	PAGE NO.
9553	NAD-29467	1T15M9	Composite	WC1-358-9453	W01-358-9392	49
9553	NAD-29467	1T15M9	Composite	WC1-358-9453	W01-358-9394	59
9553	NAD-29467	1T15M9	Composite	WC1-358-9453	W01-358-9501	70
9553	NAD-29467	1T15M9	Composite	WC1-358-9453	W01-358-9504	70
9557	NAD-31181	1T15MP6	Composite	N/A	W01-358-6258	71
9557	NAD-31181	1T15MP6	Composite	N/A	W01-358-6262	62
9560	NAD-32768	1T15M6	Composite	WC1-358-1620	W01-358-9213	48
9560	NAD-32768	1T15M6	Composite	WC1-358-1620	W01-358-9219	48
9560	NAD-32768	1T15M6	Composite	WC1-358-1620	W01-358-9296	49
9560	NAD-32768	1T15M6	Composite	WC1-358-1620	W01-358-9371	53
9561	NAD-32767	1T15M6	Composite	WC1-358-1606	W01-358-8831	64
9561	NAD-32767	1T15M6	Composite	WC1-358-1606	W01-358-9287	53
9561	NAD-32767	1T15M6	Composite	WC1-358-1606	W01-358-9466	49
9561	NAD-32767	1T15M6	Composite	WC1-358-1606	W01-358-9649	54
9562	NAD-33610	1T19L9	Composite	N/A	W01-358-8980	82
9562	NAD-33610	1T19L9	Composite	N/A	W01-358-9280	83
9562	NAD-33610	1T19L9	Composite	N/A	W01-358-9985	86
9565	NAD-35451	1T15	Composite	N/A	W01-358-9049	29
9565	NAD-35451	1T15 7	Composite	N/A	W01-358-9285	30
9565	NAD-35451	1T15	Composite	N/A	W01-358-9652	31
9566	NAD-35451	1T15	Composite	N/A	W01-358-9017	29
9566	NAD-35451	1T15	Composite	N/A	W01-358-9073	29
9566	NAD-35451	1T15	Composite	N/A	W01-358-9290	30
9566	NAD-35451	1T15	Composite	N/A	W01-358-9539	30
9566	NAD-35451	1T15	Composite	N/A	W01-358-9592	30
9566	NAD-35451	1T15	Composite	N/A	W01-358-9595	31
9567	NAD-35451	1T15	Aluminum	N/A	W01-358-8478	29
9567	NAD-35451	1T15	Aluminum	N/A	W01-358-9587	30
9567	NAD-35451	1T15	Aluminum	N/A	W01-358-9597	31
9567	NAD-35451	1T15	Aluminum	N/A	W01-358-9599	31
9567	NAD-35451	1T15	Aluminum	N/A	W01-358-9953	32
9569	NAD-27754	1T15KW0	Composite	WC1-358-1629	W01-358-9541	26
9569	NAD-27754	1T15KW0	Composite	WC1-358-1629	W01-358-9547	25
9569	NAD-27754	1T15KW0	Composite	WC1-358-1629	W01-358-9554	28
9569	NAD-27754	1T15KW0	Composite	WC1-358-1629	W01-358-9617	25
9569	NAD-27754	1T15KW0	Composite	WC1-358-1629	W01-358-9618	26
9569	NAD-27754	1T15KW0	Composite	WC1-358-1629	W01-358-9622	26
9569	NAD-27754	1T15KW0	Composite	WC1-358-1629	W01-358-9625	26
9569	NAD-27754	1T15KW0	Composite	WC1-358-1629	W01-358-9675	26
9570	NAD-18162	1T15KW1.5	Composite	N/A	W01-358-8970	35

PRIMARY TRUCK & TRAILER
INDEX BY PISTON COMPONENT NUMBER

PISTON COMP NO.	PISTON DRAWING NO.	PISTON TYPE	PISTON MATERIALS	PISTON AON	FIRESTONE AON	PAGE NO.
9570	NAD-18162	1T15KW1.5	Composite	N/A	W01-358-9306	35
9570	NAD-18162	1T15KW1.5	Composite	N/A	W01-358-9584	20
9571	NAD-18130	1T15KW1.5	Composite	WC1-358-0646	W01-358-8897	20
9571	NAD-18130	1T15KW1.5	Composite	WC1-358-0646	W01-358-8964	33
9571	NAD-18130	1T15KW1.5	Composite	WC1-358-0646	W01-358-9376	20
9571	NAD-18130	1T15KW1.5	Composite	WC1-358-0646	W01-358-9422	19
9571	NAD-18130	1T15KW1	Composite	WC1-358-0646	W01-358-9551	22
9571	NAD-18130	1T15KW1.5	Composite	WC1-358-0646	W01-358-9616	20
9571	NAD-18130	1T15KW1.5	Composite	WC1-358-0646	W01-358-9651	65
9572	NAD-18161	1T15KW1.5	Composite	N/A	W01-358-8961	33
9572	NAD-18161	1T15KW1.5	Composite	N/A	W01-358-9562	22
9572	NAD-18161	1T15KW1.5	Composite	N/A	W01-358-9750	31
9573	NAD-18162	1T15KW1.5	Composite	WC1-358-1634	W01-358-8197	36
9573	NAD-18162	1T15KW1.5	Composite	WC1-358-1634	W01-358-8204	36
9573	NAD-18162	1T15KW1.5	Composite	WC1-358-1634	W01-358-8816	41
9573	NAD-18162	1T15KW1.5	Composite	WC1-358-1634	W01-358-8817	41
9573	NAD-18162	1T15KW1.5	Composite	WC1-358-1634	W01-358-8938	37
9573	NAD-18162	1T15KW1	Composite	WC1-358-1634	W01-358-8938	37
9573	NAD-18162	1T15KW1.5	Composite	WC1-358-1634	W01-358-8971	33
9573	NAD-18162	1T15KW1.5	Composite	WC1-358-1634	W01-358-9294	32
9573	NAD-18162	1T15KW1.5	Composite	WC1-358-1634	W01-358-9307	35
9573	NAD-18162	1T15KW1.5	Composite	WC1-358-1634	W01-358-9335	43
9573	NAD-18162	1T15KW1	Composite	WC1-358-1634	W01-358-9339	39
9573	NAD-18162	1T15KW1.5	Composite	WC1-358-1634	W01-358-9387	21
9573	NAD-18162	1T15KW1.5	Composite	WC1-358-1634	W01-M58-9851	60
9574	NAD-38033	1T19E2	Aluminum	N/A	W01-M58-6339	86
9574	NAD-38033	1T19E2	Aluminum	N/A	W01-M58-6348	89
9580	NAD-27909	1T19F11	Composite	WC1-358-0528	W01-358-5503	86
9580	NAD-27909	1T19F11	Composite	WC1-358-0528	W01-358-5511	87
9580	NAD-27909	1T19F11	Composite	WC1-358-0528	W01-358-5514	87
9580	NAD-27909	1T19F11	Composite	WC1-358-0528	W01-358-8781	84
9580	NAD-27909	1T19F11	Composite	WC1-358-0528	W01-358-8796	85
9580	NAD-27909	1T19F11	Composite	WC1-358-0528	W01-358-9122	85
9580	NAD-27909	1T19F11	Composite	WC1-358-0528	W01-358-9156	85
9580	NAD-27909	1T19F11	Composite	WC1-358-0528	W01-358-9158	86
9583	FIP-101543	1T15L-6	Composite	N/A	W01-358-8720	75
9583	FIP-101543	1T15L-6	Composite	N/A	W01-358-9223	48
9585	FIP-101543	1T15L-6	Composite	N/A	W01-358-9749	25
9586	NAD-37432	1T15V5	Aluminum	WC1-358-1613	W01-358-8637	77
9586	NAD-37432	1T15V5	Aluminum	WC1-358-1613	W01-358-8740	74

CROSS REFERENCES

PRIMARY TRUCK & TRAILER

INDEX BY PISTON COMPONENT NUMBER

PISTON COMP NO.	PISTON DRAWING NO.	PISTON TYPE	PISTON MATERIALS	PISTON AON	FIRESTONE AON	PAGE NO.
9586	NAD-37432	1T15V5	Aluminum	WC1-358-1613	W01-358-8752	74
9586	NAD-37432	1T15V5	Aluminum	WC1-358-1613	W01-358-8753	74
9586	NAD-37432	1T15V5	Aluminum	WC1-358-1613	W01-358-9270	71
9587	FIP-101791	1T19ZK5.7	Aluminum	N/A	W01-358-8050	91
9587	FIP-101791	1T19ZK5.7	Aluminum	N/A	W01-358-8050	91
9594	NAD-28384	1T19LC5	Composite	WC1-358-1614	W01-358-8091	89
9594	NAD-28384	1T19LC5	Composite	WC1-358-1614	W01-358-8093	89
9594	NAD-28384	1T19LC5	Composite	WC1-358-1614	W01-358-8539	80
9594	NAD-28384	1T19LC5	Composite	WC1-358-1614	W01-358-8774	90
9601 (replaced by 9527)						
9602	NAD-28351	1T15V5	Aluminum	WC1-358-1613	W01-358-8637	77
9602	NAD-28351	1T15V5	Aluminum	WC1-358-1613	W01-358-8740	74
9602	NAD-28351	1T15V5	Aluminum	WC1-358-1613	W01-358-8752	74
9602	NAD-28351	1T15V5	Aluminum	WC1-358-1613	W01-358-8753	74
9602	NAD-28351	1T15V5	Aluminum	WC1-358-1613	W01-358-9270	71
9603	NAD-29630	1T15V5	Aluminum	WC1-358-1635	W01-358-8723	74
9603	NAD-29630	1T15V5	Aluminum	WC1-358-1635	W01-358-8735	79
9603	NAD-29630	1T15V5	Aluminum	WC1-358-1635	W01-358-8782	75
9603	NAD-29630	1T15V5	Aluminum	WC1-358-1635	W01-358-8828	62
9604	NAD-30174	1T15ZR6	Aluminum	WC1-358-1624	W01-358-9781	72
9606	NAD-35550	1T15M2	Aluminum	N/A	W01-358-1096	45
9606	NAD-35550	1T15M2	Aluminum	N/A	W01-358-8806	40
9606	NAD-35550	1T15M2	Aluminum	N/A	W01-358-8810	41
9606	NAD-35550	1T15M2	Aluminum	N/A	W01-358-9053	38
9606	NAD-35550	1T15M2	Aluminum	N/A	W01-358-9070	42
9606	NAD-35550	1T15M2	Aluminum	N/A	W01-358-9118	38
9606	NAD-35550	1T15M2	Aluminum	N/A	W01-358-9439	24
9606	NAD-35550	1T15M2	Aluminum	N/A	W01-358-9441	24
9606	NAD-35550	1T15M2	Aluminum	N/A	W01-358-9797	44
9606	NAD-35550	1T15M2	Composite	WC1-358-1652	W01-358-9105	38
9607	NAD-35551	1T19E1	Aluminum	WC1-358-9450	W01-358-8778	81
9607	NAD-35551	1T19E1	Aluminum	WC1-358-9450	W01-358-8779	84
9607	NAD-35551	1T19E1	Aluminum	WC1-358-9450	W01-358-8780	84
9607	NAD-35551	1T19E1	Aluminum	WC1-358-9450	W01-358-9121	82
9607	NAD-35551	1T19E1	Aluminum	WC1-358-9450	W01-358-9134	84
9607	NAD-35551	1T19E1	Aluminum	WC1-358-9450	W01-358-9135	82
9607	NAD-35551	1T19E1	Aluminum	WC1-358-9450	W01-358-9138	85
9607	NAD-35551	1T19E1	Aluminum	WC1-358-9450	W01-358-9141	82
9607	NAD-35551	1T19E1	Aluminum	WC1-358-9450	W01-358-9144	82
9607	NAD-35551	1T19E1	Aluminum	WC1-358-9450	W01-358-9148	83

PRIMARY TRUCK & TRAILER
INDEX BY PISTON COMPONENT NUMBER

PISTON COMP NO.	PISTON DRAWING NO.	PISTON TYPE	PISTON MATERIALS	PISTON AON	FIRESTONE AON	PAGE NO.
9607	NAD-35551	1T19E1	Aluminum	WC1-358-9450	W01-358-9149	83
9607	NAD-35551	1T19E1	Aluminum	WC1-358-9450	W01-358-9177	83
9607	NAD-35551	1T19E1	Aluminum	WC1-358-9450	W01-358-9221	83
9607	NAD-35551	1T19E1	Aluminum	WC1-358-9450	W01-358-9804	86
9612	NAD-38338	1T19E2	Aluminum	N/A	W01-358-8792	85
9612	NAD-38338	1T19F11	Composite	WC1-358-0528	W01-358-9122	85
9612	NAD-38338	1T19E2	Composite	WC1-358-0528	W01-358-9122	85
9614	NAD-39259	1T15ZR6	Aluminum	WC1-358-1624	W01-358-9781	72
9616	FIP-103585	1T15V5	Aluminum	WC1-358-1635	W01-358-8723	74
9616	FIP-103585	1T15V5	Aluminum	WC1-358-1635	W01-358-8735	79
9616	FIP-103585	1T15V5	Aluminum	WC1-358-1635	W01-358-8782	75
9616	FIP-103585	1T15V5	Aluminum	WC1-358-1635	W01-358-8828	62
9617	FIP-103589	1T14C3	Aluminum	WC1-358-9095	W01-358-5343	13
9617	FIP-103589	1T14C3	Aluminum	WC1-358-9095	W01-358-5354	16
9617	FIP-103589	1T14C3	Aluminum	WC1-358-9095	W01-358-5423	14
9617	FIP-103589	1T14C3	Aluminum	WC1-358-9095	W01-358-8868	16
9618	FIP-103583	1T15MM9	Aluminum	WC1-358-1694	W01-358-8944	61
9618	FIP-103583	1T15MM9	Aluminum	WC1-358-1694	W01-358-9265	61
9618	FIP-103583	1T15MM9	Aluminum	WC1-358-1694	W01-358-9299	64
9620	FIP-103587	1T14F4	Aluminum	N/A	W01-358-5335	15
9620	FIP-103587	1T14F4	Aluminum	N/A	W01-358-5336	15
9620	FIP-103587	1T14F4	Aluminum	N/A	W01-358-5345	15
9620	FIP-103587	1T14F4	Aluminum	N/A	W01-358-5410	14
9620	FIP-103587	1T14F4	Aluminum	N/A	W01-358-5412	14
9620	FIP-103587	1T14F4	Aluminum	N/A	W01-358-5414	14
9620	FIP-103587	1T14F4	Aluminum	N/A	W01-358-5426	17
9621	FIP-103588	1T15M4	Aluminum	WC1-358-0651	W01-358-8805	40
9621	FIP-103588	1T15M4	Aluminum	WC1-358-0651	W01-358-9010	41
9621	FIP-103588	1T15M4	Aluminum	WC1-358-0651	W01-358-9056	42
9621	FIP-103588	1T15M4	Aluminum	WC1-358-0651	W01-358-9059	42
9621	FIP-103588	1T15M4	Aluminum	WC1-358-0651	W01-358-9071	42
9621	FIP-103588	1T15M4	Aluminum	WC1-358-0651	W01-358-9474	50
9621	FIP-103588	1T15M4	Aluminum	WC1-358-0651	W01-358-9491	70
9621	FIP-103588	1T15M4	Aluminum	WC1-358-0651	W01-358-9507	44
9622	FIP-103584	1T15M2	Aluminum	WC1-358-1608	W01-358-9640	63
9639	NAD-37120	1T15DR	Steel	N/A	W01-358-8525	19
9640	FIP-101136	1T19ZK5.7	Aluminum	N/A	W01-358-8050	91
9644	NAD-31862	1T19ZR6.2	Steel	WC1-358-9999	W01-358-5523	90
9644	NAD-31862	1T19ZR6.2	Steel	WC1-358-9999	W01-358-8052	91
9644	NAD-31862	1T19ZR6.2	Steel	WC1-358-9999	W01-358-8053	91

PRIMARY TRUCK & TRAILER

INDEX BY PISTON COMPONENT NUMBER

PISTON COMP NO.	PISTON DRAWING NO.	PISTON TYPE	PISTON MATERIALS	PISTON AON	FIRESTONE AON	PAGE NO.
9645	NAD-31622	1T15CCR6	Steel	N/A	W01-358-8184	19
9646	NAD-31215	1T17B17	Steel	N/A	W01-358-8724	76
9648	NAD-31288	1T17B4	Steel	WC1-358-1649	W01-358-8614	78
9648	NAD-31288	1T17B4	Steel	WC1-358-1649	W01-358-8631	74
9648	NAD-31288	1T17B4	Steel	WC1-358-1649	W01-358-8800	71
9651	NBD-11498	1T14C3	Aluminum	WC1-358-9095	W01-358-2120	12
9651	NBD-11498	1T14C3	Aluminum	WC1-358-9095	W01-358-5343	13
9651	NBD-11498	1T14C3	Aluminum	WC1-358-9095	W01-358-5354	16
9651	NBD-11498	1T14C3	Aluminum	WC1-358-9095	W01-358-5423	14
9651	NBD-11498	1T14C3	Aluminum	WC1-358-9095	W01-358-8868	16
9652	NBD-10436	1T15M6	Aluminum	N/A	W01-358-9971	52
9652	NBD-10436	1T15M6	Aluminum	N/A	W01-358-9974	53
9652	NDD-3581	1T15M6	Aluminum	N/A	W01-358-9974	53
9652	NBD-10436	(replaced by 9530)				
9653	NBD-10437	1T15M9	Aluminum	WC1-358-0620	W01-358-9106	57
9653	NBD-10437	1T15M9	Aluminum	WC1-358-0620	W01-358-9321	60
9653	NBD-10437	1T15M9	Aluminum	WC1-358-0620	W01-358-9367	60
9653	NBD-12639	(replaced by 9553)				
9654	NBD-10438	1T15M0	Aluminum	WC1-358-0663	W01-358-9031	34
9654	NBD-10438	1T15M0	Aluminum	WC1-358-0663	W01-358-9036	34
9654	NBD-10438	1T15M0	Aluminum	WC1-358-0663	W01-358-9308	34
9654	NBD-10438	1T15M0	Aluminum	WC1-358-0663	W01-358-9333	35
9654	NBD-10438	1T15M0	Aluminum	WC1-358-0663	W01-358-9334	35
9654	NBD-10438	1T15M0	Aluminum	WC1-358-0663	W01-358-9650	65
9655	NBD-10439	1T15M0	Aluminum	WC1-358-9454	W01-358-8963	33
9655	NBD-10439	1T15M0	Aluminum	WC1-358-9454	W01-358-9033	34
9655	NBD-10439	1T15M0	Aluminum	WC1-358-9454	W01-358-9039	34
9655	NBD-10439	1T15M0	Aluminum	WC1-358-9454	W01-358-9423	66
9656	NAD-35550	1T15M2	Aluminum	N/A	W01-358-9118	38
9656	NBD-10440	1T15M2	Aluminum	N/A	W01-358-1096	45
9656	NBD-10440	1T15M2	Aluminum	N/A	W01-358-8806	40
9656	NBD-10440	1T15M2	Aluminum	N/A	W01-358-8810	41
9656	NBD-10440	1T15M2	Aluminum	N/A	W01-358-9053	38
9656	NBD-10440	1T15M2	Aluminum	N/A	W01-358-9070	42
9656	NBD-10440	1T15M2	Aluminum	N/A	W01-358-9118	38
9656	NBD-10440	1T15M2	Aluminum	N/A	W01-358-9439	24
9656	NBD-10440	1T15M2	Aluminum	N/A	W01-358-9441	24
9656	NBD-10440	1T15M2	Aluminum	N/A	W01-358-9797	44
9657	NAD-18101	1T19E1	Aluminum	WC1-358-9450	W01-358-8778	81
9657	NAD-18101	1T19E1	Aluminum	WC1-358-9450	W01-358-8780	84

PRIMARY TRUCK & TRAILER
INDEX BY PISTON COMPONENT NUMBER

PISTON COMP NO.	PISTON DRAWING NO.	PISTON TYPE	PISTON MATERIALS	PISTON AON	FIRESTONE AON	PAGE NO.	
9657	NAD-18101	1T19E1	Aluminum	WC1-358-9450	W01-358-9121	82	
9657	NAD-18101	1T19E1	Aluminum	WC1-358-9450	W01-358-9134	84	
9657	NAD-18101	1T19E1	Aluminum	WC1-358-9450	W01-358-9138	85	
9657	NAD-18101	1T19E1	Aluminum	WC1-358-9450	W01-358-9141	82	
9657	NAD-18101	1T19E1	Aluminum	WC1-358-9450	W01-358-9144	82	
9657	NAD-18101	1T19E1	Aluminum	WC1-358-9450	W01-358-9148	83	
9657	NAD-18101	1T19E1	Aluminum	WC1-358-9450	W01-358-9149	83	
9657	NAD-18101	1T19E1	Aluminum	WC1-358-9450	W01-358-9177	83	
9657	NAD-18101	1T19E1	Aluminum	WC1-358-9450	W01-358-9221	83	
9657	NAD-18101	1T19E1	Aluminum	WC1-358-9450	W01-358-9804	86	
9658	NAD-18102	1T19E2	Aluminum	N/A	W01-358-8792	85	
9658	NAD-18102	(replaced by 9580)					
9659	NBD-10472	1T15T3	Aluminum	N/A	W01-358-8597	28	
9659	NBD-10472	1T15T3	Aluminum	N/A	W01-358-8916	23	
9659	NBD-10472	1T15T3	Aluminum	N/A	W01-358-8922	23	
9659	NBD-10472	1T15T3	Aluminum	N/A	W01-358-8941	23	
9659	NBD-10472	1T15T3	Aluminum	N/A	W01-358-9445	21	
9659	NBD-10472	1T15T3	Aluminum	N/A	W01-358-9447	21	
9659	NBD-10472	1T15T3	Aluminum	N/A	W01-358-9448	21	
9659	NBD-10472	1T15T3	Aluminum	N/A	W01-358-9457	21	
9659	NBD-10472	1T15T3	Aluminum	N/A	W01-358-9459	22	
9659	NBD-10472	1T15T3	Aluminum	N/A	W01-358-9477	22	
9663	NBD-12639	1T15L2	Aluminum	N/A	W01-358-9379	27	
9663	NBD-12639	1T15	Aluminum	N/A	W01-358-9565	27	
9663	NBD-12639	1T15 2	Aluminum	N/A	W01-358-9566	27	
9663	NBD-12639	1T15 2	Aluminum	N/A	W01-358-9567	27	
9663	NBD-12639	1T15	Aluminum	N/A	W01-358-9568	28	
9666	NAD-19631	1T19G9	Aluminum	N/A	W01-358-8793	90	
9666	NAD-19631	1T19G9	Aluminum	N/A	W01-358-9825	90	
9668	NAD-18727	(replaced by 9669)					
9669	NAD-26291	1T19F12	Aluminum	WC1-358-1602	W01-358-5505	87	
9669	NAD-26291	1T19F12	Aluminum	WC1-358-1602	W01-358-5508	87	
9669	NAD-26291	1T19F12	Aluminum	WC1-358-1602	W01-358-9264	88	
9669	NAD-26291	1T19F12	Aluminum	WC1-358-1602	W01-358-9891	87	
9669	NAD-26291	1T19F12	Aluminum	WC1-358-1602	W01-358-9896	88	
9669	NAD-26291	1T19F12	Aluminum	WC1-358-1602	W01-358-9915	88	
9669	NAD-26291	1T19F12	Aluminum	WC1-358-1602	W01-358-9928	88	
9676	NAD-31612	1T15ZR6	Steel	N/A	W01-358-9782	72	
9680	NBD-10444	(replaced by 9681)					
9681	NBD-14213	1T15Y1	Aluminum	N/A	W01-358-5770	66	

PRIMARY TRUCK & TRAILER

INDEX BY PISTON COMPONENT NUMBER

PISTON COMP NO.	PISTON DRAWING NO.	PISTON TYPE	PISTON MATERIALS	PISTON AON	FIRESTONE AON	PAGE NO.
9681	NBD-14213	1T15Y1	Aluminum	N/A	W01-358-5772	66
9681	NBD-14213	1T15Y1	Aluminum	N/A	W01-358-5775	66
9681	NBD-14213	1T15Y1	Aluminum	N/A	W01-358-5776	67
9681	NBD-14213	1T15Y1	Aluminum	N/A	W01-358-5777	67
9681	NBD-14213	1T15Y1	Aluminum	N/A	W01-358-5783	67
9681	NBD-14213	1T15Y1	Aluminum	N/A	W01-358-5789	67
9681	NBD-14213	1T15Y1	Aluminum	N/A	W01-358-9586	68
9686	NAD-28449	(replaced by 9646)				
9691	NBD-14503	1T15L4	Aluminum	N/A	W01-358-9415	24
9694	NAD-25396	1T15MM9	Aluminum	WC1-358-1694	W01-358-8944	61
9694	NAD-25396	1T15MM9	Aluminum	WC1-358-1694	W01-358-9265	61
9694	NAD-25396	1T15MM9	Aluminum	WC1-358-1694	W01-358-9299	64
9699	NAD-33165	1T17BM6	Aluminum	N/A	W01-358-8673	76
9702	NAD-27357	1T15M2	Aluminum	WC1-358-1608	W01-358-9640	63
9708	NBD-8626	1T14C1	Aluminum	WC1-358-0600	W01-358-5310	12
9708	NBD-8626	1T14C1	Aluminum	WC1-358-0600	W01-358-5311	12
9708	NBD-8626	1T14C1	Aluminum	WC1-358-0600	W01-358-5323	13
9708	NBD-8626	1T14C1	Aluminum	WC1-358-0600	W01-358-5405	13
9708	NBD-8626	1T14C1	Aluminum	WC1-358-0600	W01-358-5406	13
9708	NBD-8626	1T14C1	Aluminum	WC1-358-0600	W01-358-5408	13
9708	NBD-8626	1T14C1	Aluminum	WC1-358-0600	W01-358-5422	14
9708	NBD-8626	1T14C1	Aluminum	WC1-358-0600	W01-358-5434	15
9708	NBD-8626	1T14C1	Aluminum	WC1-358-0600	W01-358-5710	17
9708	NBD-8626	1T14C1	Aluminum	WC1-358-0600	W01-358-5712	17
9727	NBD-8724	1T15M4	Aluminum	WC1-358-0651	W01-358-8805	40
9727	NBD-8724	1T15M4	Aluminum	WC1-358-0651	W01-358-9010	41
9727	NBD-8724	1T15M4	Aluminum	WC1-358-0651	W01-358-9056	42
9727	NBD-8724	1T15M4	Aluminum	WC1-358-0651	W01-358-9059	42
9727	NBD-8724	1T15M4	Aluminum	WC1-358-0651	W01-358-9071	42
9727	NBD-8724	1T15M4	Aluminum	WC1-358-0651	W01-358-9474	50
9727	NBD-8724	1T15M4	Aluminum	WC1-358-0651	W01-358-9491	70
9727	NBD-8724	1T15M4	Aluminum	WC1-358-0651	W01-358-9507	44
9734	NAD-28002	1T15M6	Aluminum	WC1-358-1610	W01-358-8755	75
9742	NBD-8055	1T15M2	Aluminum	N/A	W01-358-9078	38
9753	NAD-16485	1T19E2	Aluminum	N/A	W01-M58-6339	86
9754	NBD-11689	1T14C7	Aluminum	WC1-358-1603	W01-358-5429	18
9754	NBD-11689	1T14C7	Aluminum	WC1-358-1603	W01-358-5439	16
9754	NBD-11689	1T14C7	Aluminum	WC1-358-1603	W01-358-5702	17
9754	NBD-11689	1T14C7	Aluminum	WC1-358-1603	W01-358-8977	16
9754	NBD-11689	1T14C7	Aluminum	WC1-358-1603	W01-358-8979	17

PRIMARY TRUCK & TRAILER
INDEX BY PISTON COMPONENT NUMBER

PISTON COMP NO.	PISTON DRAWING NO.	PISTON TYPE	PISTON MATERIALS	PISTON AON	FIRESTONE AON	PAGE NO.
9757	NBD-9242	(replaced by 9567)				
9760	NAD-11668	(replaced by 9482)				
9766	NAD-28978	1T19G5	Aluminum	WC1-358-0631	W01-358-5530	90
9766	NAD-28978	1T19G5	Aluminum	WC1-358-0631	W01-358-8092	89
9766	NAD-28978	1T19G5	Aluminum	WC1-358-0631	W01-358-8500	80
9766	NAD-28978	1T19G5	Aluminum	WC1-358-0631	W01-358-8760	80
9766	NAD-28978	1T19G5	Aluminum	WC1-358-0631	W01-358-9200	80
9766	NAD-28978	1T19G5	Aluminum	WC1-358-0631	W01-358-9206	81
9766	NAD-28978	1T19G5	Aluminum	WC1-358-0631	W01-358-9215	81
9766	NAD-28978	1T19G5	Aluminum	WC1-358-0631	W01-358-9218	81
9766	NAD-28978	1T19G5	Aluminum	WC1-358-0631	W01-358-9801	81
9766	NAD-28978	1T19G5	Aluminum	WC1-358-0631	W01-358-9811	84
9767	NAD-15321	(replaced by 9766)				
9778	NAD-18053	1T14F4	Aluminum	N/A	W01-358-5335	15
9778	NAD-18053	1T14F4	Aluminum	N/A	W01-358-5336	15
9778	NAD-18053	1T14F4	Aluminum	N/A	W01-358-5345	15
9778	NAD-18053	1T14F4	Aluminum	N/A	W01-358-5410	14
9778	NAD-18053	1T14F4	Aluminum	N/A	W01-358-5412	14
9778	NAD-18053	1T14F4	Aluminum	N/A	W01-358-5414	14
9778	NAD-18053	1T14F4	Aluminum	N/A	W01-358-5426	17
9786	NBD-8514	(replaced by 9691)				
9796	NAD-17742	(replaced by 9666)				
9802	NAD-27999	1T17B7	Aluminum	WC1-358-1611	W01-358-8710	79
9803	NAD-15324	1T15V11	Aluminum	WC1-358-0680	W01-358-9250	70
9804	NBD-9171	(replaced by 9528)				
9809	NBD-9611	1T15L6	Aluminum	N/A	W01-358-9966	50
9809	NDD-3581	1T15L6	Aluminum	N/A	W01-358-9966	50
9809	NBD-9611	(replaced by 9583)				
9889	NBD-9253	1T26D7	Aluminum	N/A	W01-358-9310	91
9889	NBD-9253	1T26D7	Aluminum	N/A	W01-358-9327	91
9951	NAD-17833	1T15M6	Aluminum	WC1-358-0697	W01-358-9210	47
9951	NAD-17833	1T15M6	Aluminum	WC1-358-0697	W01-358-9211	48

PRIMARY TRUCK & TRAILER

INDEX BY PISTON DRAWING NUMBER

PISTON DRAWING NO.	PISTON COMP. NO.	PISTON TYPE	PISTON MATERIALS	PISTON AON	FIRESTONE AON	PAGE NO.
FIP-100742	9492	1T15T0	Composite	N/A	W01-358-5766	65
FIP-100742	9492	1T15T0	Composite	N/A	W01-358-5792	67
FIP-100742	9492	1T15T0	Composite	N/A	W01-358-9401	65
FIP-100742	9492	1T15T0	Composite	N/A	W01-358-9402	65
FIP-100742	9492	1T15T0	Composite	N/A	W01-358-9421	66
FIP-100743	9493	1T14C1	Composite	N/A	W01-358-5298	18
FIP-100743	9493	1T14C1	Composite	N/A	W01-358-5319	18
FIP-100743	9493	1T14C1	Composite	N/A	W01-358-5730	16
FIP-100743	9493	1T14C1	Composite	N/A	W01-358-9478	15
FIP-100744	9491	1T14C1	Composite	N/A	W01-358-2119	12
FIP-100744	9491	1T14C1	Composite	N/A	W01-358-2131	12
FIP-100744	9491	1T14C1	Composite	N/A	W01-358-5297	18
FIP-100744	9491	1T14C1	Composite	N/A	W01-358-5379	18
FIP-100744	9491	1T14C1	Composite	N/A	W01-358-8992	19
FIP-100744	9491	1T14C1	Composite	N/A	W01-358-8997	19
FIP-101012	9490	1T15M2	Composite	N/A	W01-358-8195	36
FIP-101012	9490	1T15M2	Composite	N/A	W01-358-9469	24
FIP-101115	9488	1T17C8	Composite	N/A	W01-358-8109	77
FIP-101136	9640	1T19ZK5.7	Aluminum	N/A	W01-358-8050	91
FIP-101211	9489	1T15	Composite	WC1-358-1660	W01-358-9807	39
FIP-101361	9489	1T15	Composite	WC1-358-1660	W01-358-9807	39
FIP-101468	9484	1T15M6	Composite	WC1-358-1674	W01-358-9978	44
FIP-101526	4008	1T15MR	Composite	N/A	W01-358-1190	73
FIP-101526	4008	1T15MR	Composite	N/A	W01-358-1191	73
FIP-101526	4008	1T15MR	Composite	N/A	W01-358-1192	73
FIP-101526	4008	1T15MR	Composite	N/A	W01-358-8829	72
FIP-101526	4008	1T15MR	Composite	N/A	W01-358-9648	73
FIP-101526	4008	1T15MR	Composite	N/A	W01-M58-8463	72
FIP-101526	4008	1T15MR	Composite	N/A	W01-M58-8468	73
FIP-101543	9583	1T15L-6	Composite	N/A	W01-358-8720	75
FIP-101543	9583	1T15L-6	Composite	N/A	W01-358-9223	48
FIP-101543	9585	1T15L-6	Composite	N/A	W01-358-9749	25
FIP-101678	9461	1T66	Steel	N/A	W01-358-8984	92
FIP-101705	9485	1T15MR8	Composite	N/A	W01-358-9865	71
FIP-101705	9485	1T15MR8	Composite	N/A	W01-358-9866	71
FIP-101776	9462	1T15V7	Composite	N/A	W01-358-9274	68
FIP-101776	9462	1T15V7	Composite	N/A	W01-358-9275	69
FIP-101776	9462	1T15V7	Composite	N/A	W01-358-9467	43

PRIMARY TRUCK & TRAILER
INDEX BY PISTON DRAWING NUMBER

PISTON DRAWING NO.	PISTON COMP. NO.	PISTON TYPE	PISTON MATERIALS	PISTON AON	FIRESTONE AON	PAGE NO.
FIP-101791	9587	1T19ZK5.7	Aluminum	N/A	W01-358-8050	91
FIP-101791	9587	1T19ZK5.7	Aluminum	N/A	W01-358-8050	91
FIP-103583	9618	1T15MM9	Aluminum	WC1-358-1694	W01-358-8944	61
FIP-103583	9618	1T15MM9	Aluminum	WC1-358-1694	W01-358-9265	61
FIP-103583	9618	1T15MM9	Aluminum	WC1-358-1694	W01-358-9299	64
FIP-103584	9622	1T15M2	Aluminum	WC1-358-1608	W01-358-9640	63
FIP-103585	9616	1T15V5	Aluminum	WC1-358-1635	W01-358-8723	74
FIP-103585	9616	1T15V5	Aluminum	WC1-358-1635	W01-358-8735	79
FIP-103585	9616	1T15V5	Aluminum	WC1-358-1635	W01-358-8782	75
FIP-103585	9616	1T15V5	Aluminum	WC1-358-1635	W01-358-8828	62
FIP-103587	9620	1T14F4	Aluminum	N/A	W01-358-5335	15
FIP-103587	9620	1T14F4	Aluminum	N/A	W01-358-5336	15
FIP-103587	9620	1T14F4	Aluminum	N/A	W01-358-5345	15
FIP-103587	9620	1T14F4	Aluminum	N/A	W01-358-5410	14
FIP-103587	9620	1T14F4	Aluminum	N/A	W01-358-5412	14
FIP-103587	9620	1T14F4	Aluminum	N/A	W01-358-5414	14
FIP-103587	9620	1T14F4	Aluminum	N/A	W01-358-5426	17
FIP-103588	9621	1T15M4	Aluminum	WC1-358-0651	W01-358-8805	40
FIP-103588	9621	1T15M4	Aluminum	WC1-358-0651	W01-358-9010	41
FIP-103588	9621	1T15M4	Aluminum	WC1-358-0651	W01-358-9056	42
FIP-103588	9621	1T15M4	Aluminum	WC1-358-0651	W01-358-9059	42
FIP-103588	9621	1T15M4	Aluminum	WC1-358-0651	W01-358-9071	42
FIP-103588	9621	1T15M4	Aluminum	WC1-358-0651	W01-358-9474	50
FIP-103588	9621	1T15M4	Aluminum	WC1-358-0651	W01-358-9491	70
FIP-103588	9621	1T15M4	Aluminum	WC1-358-0651	W01-358-9507	44
FIP-103589	9617	1T14C3	Aluminum	WC1-358-9095	W01-358-5343	13
FIP-103589	9617	1T14C3	Aluminum	WC1-358-9095	W01-358-5354	16
FIP-103589	9617	1T14C3	Aluminum	WC1-358-9095	W01-358-5423	14
FIP-103589	9617	1T14C3	Aluminum	WC1-358-9095	W01-358-8868	16
FIP-103594	9478	1T15M6	Aluminum	WC1-358-1610	W01-358-8755	75
FIP-103894	6853	1T14C1	Aluminum	WC1-358-0600	W01-358-5310	12
FIP-103894	6853	1T14C1	Aluminum	WC1-358-0600	W01-358-5311	12
FIP-103894	6853	1T14C1	Aluminum	WC1-358-0600	W01-358-5323	13
FIP-103894	6853	1T14C1	Aluminum	WC1-358-0600	W01-358-5405	13
FIP-103894	6853	1T14C1	Aluminum	WC1-358-0600	W01-358-5406	13
FIP-103894	6853	1T14C1	Aluminum	WC1-358-0600	W01-358-5408	13
FIP-103894	6853	1T14C1	Aluminum	WC1-358-0600	W01-358-5422	14
FIP-103894	6853	1T14C1	Aluminum	WC1-358-0600	W01-358-5434	15

PRIMARY TRUCK & TRAILER

INDEX BY PISTON DRAWING NUMBER

PISTON DRAWING NO.	PISTON COMP. NO.	PISTON TYPE	PISTON MATERIALS	PISTON AON	FIRESTONE AON	PAGE NO.
FIP-103894	6853	1T14C1	Aluminum	WC1-358-0600	W01-358-5712	17
FIP-103896	6851	1T15M0	Aluminum	WC1-358-0663	W01-358-9031	34
FIP-103896	6851	1T15M0	Aluminum	WC1-358-0663	W01-358-9036	34
FIP-103896	6851	1T15M0	Aluminum	WC1-358-0663	W01-358-9308	34
FIP-103896	6851	1T15M0	Aluminum	WC1-358-0663	W01-358-9334	35
FIP-103896	6851	1T15M0	Aluminum	WC1-358-0663	W01-358-9650	65
FIP-103897	6850	1T15M2	Aluminum	N/A	W01-358-9391	24
FIP-103897	6851	1T15M3	Aluminum	N/A	W01-358-9391	24
FIP-103898	6849	1T15M6	Aluminum	N/A	W01-358-9971	52
FIP-103898	6849	1T15M6	Aluminum	N/A	W01-358-9974	53
FIP-103899	6848	1T19G5	Aluminum	WC1-358-0631	W01-358-5530	90
FIP-103899	6848	1T19G5	Aluminum	WC1-358-0631	W01-358-8500	80
FIP-103899	6848	1T19G5	Aluminum	WC1-358-0631	W01-358-8760	80
FIP-103899	6848	1T19G5	Aluminum	WC1-358-0631	W01-358-9200	80
FIP-103899	6848	1T19G5	Aluminum	WC1-358-0631	W01-358-9206	81
FIP-103899	6848	1T19G5	Aluminum	WC1-358-0631	W01-358-9215	81
FIP-103899	6848	1T19G5	Aluminum	WC1-358-0631	W01-358-9218	81
FIP-103899	6848	1T19G5	Aluminum	WC1-358-0631	W01-358-9801	81
FIP-103899	6848	1T19G5	Aluminum	WC1-358-0631	W01-358-9811	84
FIP-103899	6848	1T19G5	Aluminum	WC1-358-0631	W01-358-9200	80
FIP-103901	6846	1T19G9	Aluminum	N/A	W01-358-8793	90
FIP-103901	6846	1T19G9	Aluminum	N/A	W01-358-9825	90
FIP-103902	6845	1T17B7	Aluminum	WC1-358-1611	W01-358-8710	79
FIP-103972	6836	1T15M4	Composite	WC1-358-0666	W01-358-9069	42
NAD-15324	9803	1T15V11	Aluminum	WC1-358-0680	W01-358-9250	70
NAD-16485	9753	1T19E2	Aluminum	N/A	W01-M58-6339	86
NAD-17160	3808	1T19E1	Aluminum	N/A	W01-M58-8775	88
NAD-17833	9951	1T15M6	Aluminum	WC1-358-0697	W01-358-9210	47
NAD-17833	9951	1T15M6	Aluminum	WC1-358-0697	W01-358-9211	48
NAD-18053	9778	1T14F4	Aluminum	N/A	W01-358-5335	15
NAD-18053	9778	1T14F4	Aluminum	N/A	W01-358-5336	15
NAD-18053	9778	1T14F4	Aluminum	N/A	W01-358-5345	15
NAD-18053	9778	1T14F4	Aluminum	N/A	W01-358-5410	14
NAD-18053	9778	1T14F4	Aluminum	N/A	W01-358-5412	14
NAD-18053	9778	1T14F4	Aluminum	N/A	W01-358-5414	14
NAD-18053	9778	1T14F4	Aluminum	N/A	W01-358-5426	17
NAD-18101	9657	1T19E1	Aluminum	WC1-358-9450	W01-358-8778	81
NAD-18101	9657	1T19E1	Aluminum	WC1-358-9450	W01-358-8780	84

PRIMARY TRUCK & TRAILER
INDEX BY PISTON DRAWING NUMBER

PISTON DRAWING NO.	PISTON COMP. NO.	PISTON TYPE	PISTON MATERIALS	PISTON AON	FIRESTONE AON	PAGE NO.
NAD-18101	9657	1T19E1	Aluminum	WC1-358-9450	W01-358-9121	82
NAD-18101	9657	1T19E1	Aluminum	WC1-358-9450	W01-358-9134	84
NAD-18101	9657	1T19E1	Aluminum	WC1-358-9450	W01-358-9138	85
NAD-18101	9657	1T19E1	Aluminum	WC1-358-9450	W01-358-9141	82
NAD-18101	9657	1T19E1	Aluminum	WC1-358-9450	W01-358-9144	82
NAD-18101	9657	1T19E1	Aluminum	WC1-358-9450	W01-358-9148	83
NAD-18101	9657	1T19E1	Aluminum	WC1-358-9450	W01-358-9149	83
NAD-18101	9657	1T19E1	Aluminum	WC1-358-9450	W01-358-9177	83
NAD-18101	9657	1T19E1	Aluminum	WC1-358-9450	W01-358-9221	83
NAD-18101	9657	1T19E1	Aluminum	WC1-358-9450	W01-358-9804	86
NAD-18102	9658	1T19E2	Aluminum	N/A	W01-358-8792	85
NAD-18130	9571	1T15KW1.5	Composite	WC1-358-0646	W01-358-8897	20
NAD-18130	9571	1T15KW1.5	Composite	WC1-358-0646	W01-358-8964	33
NAD-18130	9571	1T15KW1.5	Composite	WC1-358-0646	W01-358-9376	20
NAD-18130	9571	1T15KW1.5	Composite	WC1-358-0646	W01-358-9422	19
NAD-18130	9571	1T15KW1	Composite	WC1-358-0646	W01-358-9551	22
NAD-18130	9571	1T15KW1.5	Composite	WC1-358-0646	W01-358-9616	20
NAD-18130	9571	1T15KW1.5	Composite	WC1-358-0646	W01-358-9651	65
NAD-18161	9572	1T15KW1.5	Composite	N/A	W01-358-8961	33
NAD-18161	9572	1T15KW1.5	Composite	N/A	W01-358-9562	22
NAD-18161	9572	1T15KW1.5	Composite	N/A	W01-358-9750	31
NAD-18162	9570	1T15KW1.5	Composite	N/A	W01-358-8970	35
NAD-18162	9570	1T15KW1.5	Composite	N/A	W01-358-9306	35
NAD-18162	9570	1T15KW1.5	Composite	N/A	W01-358-9584	20
NAD-18162	9573	1T15KW1.5	Composite	WC1-358-1634	W01-358-8197	36
NAD-18162	9573	1T15KW1.5	Composite	WC1-358-1634	W01-358-8204	36
NAD-18162	9573	1T15KW1.5	Composite	WC1-358-1634	W01-358-8816	41
NAD-18162	9573	1T15KW1.5	Composite	WC1-358-1634	W01-358-8817	41
NAD-18162	9573	1T15KW1.5	Composite	WC1-358-1634	W01-358-8938	37
NAD-18162	9573	1T15KW1	Composite	WC1-358-1634	W01-358-8938	37
NAD-18162	9573	1T15KW1.5	Composite	WC1-358-1634	W01-358-8971	33
NAD-18162	9573	1T15KW1.5	Composite	WC1-358-1634	W01-358-9294	32
NAD-18162	9573	1T15KW1.5	Composite	WC1-358-1634	W01-358-9307	35
NAD-18162	9573	1T15KW1.5	Composite	WC1-358-1634	W01-358-9335	43
NAD-18162	9573	1T15KW1	Composite	WC1-358-1634	W01-358-9339	39
NAD-18162	9573	1T15KW1.5	Composite	WC1-358-1634	W01-358-9387	21
NAD-18162	9573	1T15KW1.5	Composite	WC1-358-1634	W01-M58-9851	60
NAD-19631	9666	1T19G9	Aluminum	N/A	W01-358-8793	90

PRIMARY TRUCK & TRAILER

INDEX BY PISTON DRAWING NUMBER

PISTON DRAWING NO.	PISTON COMP. NO.	PISTON TYPE	PISTON MATERIALS	PISTON AON	FIRESTONE AON	PAGE NO.
NAD-19631	9666	1T19G9	Aluminum	N/A	W01-358-9825	90
NAD-25396	9694	1T15MM9	Aluminum	WC1-358-1694	W01-358-8944	61
NAD-25396	9694	1T15MM9	Aluminum	WC1-358-1694	W01-358-9265	61
NAD-25396	9694	1T15MM9	Aluminum	WC1-358-1694	W01-358-9299	64
NAD-26291	9669	1T19F12	Aluminum	WC1-358-1602	W01-358-5505	87
NAD-26291	9669	1T19F12	Aluminum	WC1-358-1602	W01-358-5508	87
NAD-26291	9669	1T19F12	Aluminum	WC1-358-1602	W01-358-9264	88
NAD-26291	9669	1T19F12	Aluminum	WC1-358-1602	W01-358-9891	87
NAD-26291	9669	1T19F12	Aluminum	WC1-358-1602	W01-358-9896	88
NAD-26291	9669	1T19F12	Aluminum	WC1-358-1602	W01-358-9915	88
NAD-26291	9669	1T19F12	Aluminum	WC1-358-1602	W01-358-9928	88
NAD-26906	9525	1T17B6	Composite	WC1-358-1609	W01-358-8709	78
NAD-27265	9527	1T15ZR6	Composite	WC1-358-1627	W01-358-9780	72
NAD-27357	9702	1T15M2	Aluminum	WC1-358-1608	W01-358-9640	63
NAD-27740	9538	1T15M6	Composite	WC1-358-1628	W01-358-8591	45
NAD-27740	9538	1T15M6	Composite	WC1-358-1628	W01-358-9297	53
NAD-27740	9538	1T15M6	Composite	WC1-358-1628	W01-358-9373	53
NAD-27740	9538	1T15M6	Composite	WC1-358-1628	W01-358-9375	54
NAD-27740	9538	1T15M6	Composite	WC1-358-1628	W01-358-9641	54
NAD-27740	9538	1T15M6	Composite	WC1-358-1628	W01-358-9643	64
NAD-27740	9538	1T15M6	Composite	WC1-358-1628	W01-358-9643	64
NAD-27740	9538	1T15M6	Composite	WC1-358-1628	W01-358-9647	54
NAD-27740	9538	1T15M6	Composite	WC1-358-1628	W01-M58-9372	55
NAD-27740	9538	1T15M6	Composite	WC1-358-1628	W01-M58-9656	55
NAD-27740	9538	1T15M6	Composite	WC1-358-1628/ WC1-358-3715	W01-358-9654	54
NAD-27740	9538	1T15M6	Composite	WC1-358-1628/ WC1-358-3715	W01-358-9663	55
NAD-27754	9569	1T15KW0	Composite	WC1-358-1629	W01-358-9541	26
NAD-27754	9569	1T15KW0	Composite	WC1-358-1629	W01-358-9547	25
NAD-27754	9569	1T15KW0	Composite	WC1-358-1629	W01-358-9554	28
NAD-27754	9569	1T15KW0	Composite	WC1-358-1629	W01-358-9617	25
NAD-27754	9569	1T15KW0	Composite	WC1-358-1629	W01-358-9618	26
NAD-27754	9569	1T15KW0	Composite	WC1-358-1629	W01-358-9622	26
NAD-27754	9569	1T15KW0	Composite	WC1-358-1629	W01-358-9625	26
NAD-27754	9569	1T15KW0	Composite	WC1-358-1629	W01-358-9675	26
NAD-27809	9530	1T15M6	Composite	WC1-358-9452	W01-358-0783	55
NAD-27809	9530	1T15M6	Composite	WC1-358-9452	W01-358-8824	45
NAD-27809	9530	1T15M6	Composite	WC1-358-9452	W01-358-8825	45

PRIMARY TRUCK & TRAILER
INDEX BY PISTON DRAWING NUMBER

PISTON DRAWING NO.	PISTON COMP. NO.	PISTON TYPE	PISTON MATERIALS	PISTON AON	FIRESTONE AON	PAGE NO.
NAD-27809	9530	1T15M6	Composite	WC1-358-9452	W01-358-8855	56
NAD-27809	9530	1T15M6	Composite	WC1-358-9452	W01-358-8861	56
NAD-27809	9530	1T15M6	Composite	WC1-358-9452	W01-358-8888	50
NAD-27809	9530	1T15M6	Composite	WC1-358-9452	W01-358-8924	45
NAD-27809	9530	1T15M6	Composite	WC1-358-9452	W01-358-8932	37
NAD-27809	9530	1T15M6	Composite	WC1-358-9452	W01-358-9082	46
NAD-27809	9530	1T15M6	Composite	WC1-358-9452	W01-358-9083	46
NAD-27809	9530	1T15M6	Composite	WC1-358-9452	W01-358-9092	46
NAD-27809	9530	1T15M6	Composite	WC1-358-9452	W01-358-9096	47
NAD-27809	9530	1T15M6	Composite	WC1-358-9452	W01-358-9192	57
NAD-27809	9530	1T15M6	Composite	WC1-358-9452	W01-358-9193	47
NAD-27809	9530	1T15M6	Composite	WC1-358-9452	W01-358-9203	57
NAD-27809	9530	1T15M6	Composite	WC1-358-9452	W01-358-9227	48
NAD-27809	9530	1T15M6	Composite	WC1-358-9452	W01-358-9245	58
NAD-27809	9530	1T15M6	Composite	WC1-358-9452	W01-358-9342	50
NAD-27809	9530	1T15M6	Composite	WC1-358-9452	W01-358-9502	70
NAD-27809	9530	1T15M6	Composite	WC1-358-9452	W01-358-9560	25
NAD-27909	9580	1T19F11	Composite	WC1-358-0528	W01-358-5503	86
NAD-27909	9580	1T19F11	Composite	WC1-358-0528	W01-358-5511	87
NAD-27909	9580	1T19F11	Composite	WC1-358-0528	W01-358-5514	87
NAD-27909	9580	1T19F11	Composite	WC1-358-0528	W01-358-8781	84
NAD-27909	9580	1T19F11	Composite	WC1-358-0528	W01-358-8796	85
NAD-27909	9580	1T19F11	Composite	WC1-358-0528	W01-358-9122	85
NAD-27909	9580	1T19F11	Composite	WC1-358-0528	W01-358-9156	85
NAD-27909	9580	1T19F11	Composite	WC1-358-0528	W01-358-9158	86
NAD-27999	9802	1T17B7	Aluminum	WC1-358-1611	W01-358-8710	79
NAD-28002	9734	1T15M6	Aluminum	WC1-358-1610	W01-358-8755	75
NAD-28198	3850	1T15MP6	Composite	N/A	W01-M58-7074	62
NAD-28198	3850	1T15MP6	Composite	N/A	W01-M58-8608	80
NAD-28351	9602	1T15V5	Aluminum	WC1-358-1613	W01-358-8637	77
NAD-28351	9602	1T15V5	Aluminum	WC1-358-1613	W01-358-8740	74
NAD-28351	9602	1T15V5	Aluminum	WC1-358-1613	W01-358-8752	74
NAD-28351	9602	1T15V5	Aluminum	WC1-358-1613	W01-358-8753	74
NAD-28351	9602	1T15V5	Aluminum	WC1-358-1613	W01-358-9270	71
NAD-28384	9594	1T19LC5	Composite	WC1-358-1614	W01-358-8091	89
NAD-28384	9594	1T19LC5	Composite	WC1-358-1614	W01-358-8093	89
NAD-28384	9594	1T19LC5	Composite	WC1-358-1614	W01-358-8539	80
NAD-28384	9594	1T19LC5	Composite	WC1-358-1614	W01-358-8774	90

PRIMARY TRUCK & TRAILER

INDEX BY PISTON DRAWING NUMBER

PISTON DRAWING NO.	PISTON COMP. NO.	PISTON TYPE	PISTON MATERIALS	PISTON AON	FIRESTONE AON	PAGE NO.
NAD-28978	9766	1T19G5	Aluminum	WC1-358-0631	W01-358-5530	90
NAD-28978	9766	1T19G5	Aluminum	WC1-358-0631	W01-358-8092	89
NAD-28978	9766	1T19G5	Aluminum	WC1-358-0631	W01-358-8500	80
NAD-28978	9766	1T19G5	Aluminum	WC1-358-0631	W01-358-8760	80
NAD-28978	9766	1T19G5	Aluminum	WC1-358-0631	W01-358-9200	80
NAD-28978	9766	1T19G5	Aluminum	WC1-358-0631	W01-358-9206	81
NAD-28978	9766	1T19G5	Aluminum	WC1-358-0631	W01-358-9215	81
NAD-28978	9766	1T19G5	Aluminum	WC1-358-0631	W01-358-9218	81
NAD-28978	9766	1T19G5	Aluminum	WC1-358-0631	W01-358-9801	81
NAD-28978	9766	1T19G5	Aluminum	WC1-358-0631	W01-358-9811	84
NAD-29454	9549	1T15M2	Composite	WC1-358-1616	W01-358-8203	36
NAD-29454	9549	1T15M2	Composite	WC1-358-1616	W01-358-8492	29
NAD-29454	9549	1T15M2	Composite	WC1-358-1616	W01-358-8647	22
NAD-29454	9549	1T15M2	Composite	WC1-358-1616	W01-358-8802	40
NAD-29454	9549	1T15M2	Composite	WC1-358-1616	W01-358-8874	23
NAD-29454	9549	1T15M2	Composite	WC1-358-1616	W01-358-8901	20
NAD-29454	9549	1T15M2	Composite	WC1-358-1616	W01-358-8919	23
NAD-29454	9549	1T15M2	Composite	WC1-358-1616	W01-358-8949	32
NAD-29454	9549	1T15M2	Composite	WC1-358-1616	W01-358-8959	28
NAD-29454	9549	1T15M2	Composite	WC1-358-1616	W01-358-9336	43
NAD-29454	9549	1T15M2	Composite	WC1-358-1616	W01-358-9366	39
NAD-29454	9549	1T15M2	Composite	WC1-358-1616	W01-358-9482	43
NAD-29454	9549	1T15M2	Composite	WC1-358-1616	W01-358-9585	44
NAD-29456	9550	1T15M2	Composite	WC1-358-1652	W01-358-8198	36
NAD-29456	9550	1T15M2	Composite	WC1-358-1652	W01-358-8466	63
NAD-29456	9550	1T15M2	Composite	WC1-358-1652	W01-358-8616	77
NAD-29456	9550	1T15M2	Composite	WC1-358-1652	W01-358-8878	37
NAD-29456	9550	1T15M2	Composite	WC1-358-1652	W01-358-9105	38
NAD-29456	9550	1T15M2	Composite	WC1-358-1652	W01-358-9303	38
NAD-29456	9550	1T15M2	Composite	WC1-358-1652	W01-358-9634	63
NAD-29467	9553	1T15M9	Composite	WC1-358-9453	W01-358-9093	47
NAD-29467	9553	1T15M9	Composite	WC1-358-9453	W01-358-9101	57
NAD-29467	9553	1T15M9	Composite	WC1-358-9453	W01-358-9130	57
NAD-29467	9553	1T15M9	Composite	WC1-358-9453	W01-358-9238	58
NAD-29467	9553	1T15M9	Composite	WC1-358-9453	W01-358-9240	58
NAD-29467	9553	1T15M9	Composite	WC1-358-9453	W01-358-9241	58
NAD-29467	9553	1T15M9	Composite	WC1-358-9453	W01-358-9320	59
NAD-29467	9553	1T15M9	Composite	WC1-358-9453	W01-358-9348	59

PRIMARY TRUCK & TRAILER
INDEX BY PISTON DRAWING NUMBER

PISTON DRAWING NO.	PISTON COMP. NO.	PISTON TYPE	PISTON MATERIALS	PISTON AON	FIRESTONE AON	PAGE NO.
NAD-29467	9553	1T15M9	Composite	WC1-358-9453	W01-358-9350	59
NAD-29467	9553	1T15M9	Composite	WC1-358-9453	W01-358-9368	60
NAD-29467	9553	1T15M9	Composite	WC1-358-9453	W01-358-9392	49
NAD-29467	9553	1T15M9	Composite	WC1-358-9453	W01-358-9394	59
NAD-29467	9553	1T15M9	Composite	WC1-358-9453	W01-358-9501	70
NAD-29467	9553	1T15M9	Composite	WC1-358-9453	W01-358-9504	70
NAD-29551	9528	1T15V1	Composite	WC1-358-0667	W01-358-8737	77
NAD-29592	9535	1T15S6	Composite	N/A	W01-358-9260	64
NAD-29592	9535	1T15S6	Composite	N/A	W01-358-9278	64
NAD-29630	9603	1T15V5	Aluminum	WC1-358-1635	W01-358-8723	74
NAD-29630	9603	1T15V5	Aluminum	WC1-358-1635	W01-358-8735	79
NAD-29630	9603	1T15V5	Aluminum	WC1-358-1635	W01-358-8782	75
NAD-29630	9603	1T15V5	Aluminum	WC1-358-1635	W01-358-8828	62
NAD-29798	9537	1T17B7	Composite	WC1-358-1637	W01-358-8708	78
NAD-29798	9537	1T17B7	Composite	WC1-358-1637	W01-358-8713	78
NAD-29826	9544	1T15M4	Composite	WC1-358-0666	W01-358-8813	41
NAD-29826	9544	1T15M4	Composite	WC1-358-0666	W01-358-8927	46
NAD-29826	9544	1T15M4	Composite	WC1-358-0666	W01-358-9069	42
NAD-29826	9544	1T15M4	Composite	WC1-358-0666	W01-358-9293	32
NAD-29826	9544	1T15M4	Composite	WC1-358-0666	W01-358-9365	39
NAD-29826	9544	1T15M4	Composite	WC1-358-0666	W01-358-9472	69
NAD-29826	9544	1T15M4	Composite	WC1-358-0666	W01-358-9484	43
NAD-29826	9544	1T15M4	Composite	WC1-358-0666	W01-358-9902	51
NAD-29826	9544	1T15M4	Composite	WC1-358-0666	W01-358-9921	51
NAD-29826	9544	1T15M4	Composite	WC1-358-0666	W01-358-9936	52
NAD-29826	9544	1T15M4	Composite	WC1-358-0666	W01-358-9947	52
NAD-29827	9531	1T15MP6	Composite	N/A	W01-358-8864	56
NAD-29827	9532	1T15M6	Composite	WC1-358-1619	W01-358-8494	62
NAD-29827	9532	1T15M6	Composite	WC1-358-1619	W01-358-8746	75
NAD-29827	9532	1T15M6	Composite	WC1-358-1619	W01-358-8748	76
NAD-29827	9532	1T15M6	Composite	WC1-358-1619	W01-358-8803	40
NAD-29827	9532	1T15M6	Composite	WC1-358-1619	W01-358-8842	55
NAD-29827	9532	1T15M6	Composite	WC1-358-1619	W01-358-8852	56
NAD-29827	9532	1T15M6	Composite	WC1-358-1619	W01-358-8856	56
NAD-29827	9532	1T15M6	Composite	WC1-358-1619	W01-358-8903	63
NAD-29827	9532	1T15M6	Composite	WC1-358-1619	W01-358-9026	46
NAD-29827	9532	1T15M6	Composite	WC1-358-1619	W01-358-9194	47
NAD-29827	9532	1T15M6	Composite	WC1-358-1619	W01-358-9243	58

PRIMARY TRUCK & TRAILER

INDEX BY PISTON DRAWING NUMBER

PISTON DRAWING NO.	PISTON COMP. NO.	PISTON TYPE	PISTON MATERIALS	PISTON AON	FIRESTONE AON	PAGE NO.
NAD-29827	9532	1T15M6	Composite	WC1-358-1619	W01-358-9295	33
NAD-29827	9532	1T15M6	Composite	WC1-358-1619	W01-358-9325	39
NAD-29827	9532	1T15M6	Composite	WC1-358-1619	W01-358-9362	49
NAD-29827	9532	1T15M6	Composite	WC1-358-1619	W01-358-9470	69
NAD-29827	9532	1T15M6	Composite	WC1-358-1619	W01-358-9496	50
NAD-29827	9532	1T15M6	Composite	WC1-358-1619	W01-358-9621	27
NAD-29827	9532	1T15M6	Composite	WC1-358-1619	W01-358-9626	25
NAD-29827	9532	1T15M6	Composite	WC1-358-1619	W01-358-9644	61
NAD-29827	9532	1T15M6	Composite	WC1-358-1619	W01-358-9646	61
NAD-29827	9532	1T15M6	Composite	WC1-358-1619	W01-358-9697	44
NAD-29827	9532	1T15M6	Composite	WC1-358-1619	W01-358-9923	51
NAD-29827	9532	1T15M6	Composite	WC1-358-1619	W01-358-9935	51
NAD-29827	9532	1T15M6	Composite	WC1-358-1619	W01-358-9942	52
NAD-29828	9540	1T15M9	Composite	WC1-358-0664	W01-358-8744	75
NAD-29828	9540	1T15M9	Composite	WC1-358-0664	W01-358-8749	76
NAD-29828	9540	1T15M9	Composite	WC1-358-0664	W01-358-9291	32
NAD-29828	9540	1T15M9	Composite	WC1-358-0664	W01-358-9304	49
NAD-29828	9540	1T15M9	Composite	WC1-358-0664	W01-358-9346	59
NAD-29828	9540	1T15M9	Composite	WC1-358-0664	W01-358-9370	60
NAD-29828	9540	1T15M9	Composite	WC1-358-0664	W01-358-9471	69
NAD-29828	9540	1T15M9	Composite	WC1-358-0664	W01-358-9473	69
NAD-29828	9540	1T15M9	Composite	WC1-358-0664	W01-358-9619	28
NAD-29828	9540	1T15M9	Composite	WC1-358-0664	W01-358-9645	61
NAD-29828	9540	1T15M9	Composite	WC1-358-0664	W01-358-9922	51
NAD-29828	9540	1T15M9	Composite	WC1-358-0664	W01-358-9943	52
NAD-30174	9604	1T15ZR6	Aluminum	WC1-358-1624	W01-358-9781	72
NAD-30515	9533	1T17BB2	Composite	N/A	W01-358-8617	79
NAD-30515	9533	1T17BB2	Composite	N/A	W01-358-8729	76
NAD-31181	9557	1T15MP6	Composite	N/A	W01-358-6258	71
NAD-31181	9557	1T15MP6	Composite	N/A	W01-358-6262	62
NAD-31215	9646	1T17B17	Steel	N/A	W01-358-8724	76
NAD-31288	9648	1T17B4	Steel	WC1-358-1649	W01-358-8614	78
NAD-31288	9648	1T17B4	Steel	WC1-358-1649	W01-358-8631	74
NAD-31288	9648	1T17B4	Steel	WC1-358-1649	W01-358-8800	71
NAD-31612	9676	1T15ZR6	Steel	N/A	W01-358-9782	72
NAD-31622	9645	1T15CCR6	Steel	N/A	W01-358-8184	19
NAD-31763	9507	1T15MP6	Composite	N/A	W01-358-6231	62
NAD-31862	9644	1T19ZR6.2	Steel	WC1-358-9999	W01-358-5523	90

PRIMARY TRUCK & TRAILER
INDEX BY PISTON DRAWING NUMBER

PISTON DRAWING NO.	PISTON COMP. NO.	PISTON TYPE	PISTON MATERIALS	PISTON AON	FIRESTONE AON	PAGE NO.
NAD-31862	9644	1T19ZR6.2	Steel	WC1-358-9999	W01-358-8052	91
NAD-31862	9644	1T19ZR6.2	Steel	WC1-358-9999	W01-358-8053	91
NAD-32767	9561	1T15M6	Composite	WC1-358-1606	W01-358-8831	64
NAD-32767	9561	1T15M6	Composite	WC1-358-1606	W01-358-9287	53
NAD-32767	9561	1T15M6	Composite	WC1-358-1606	W01-358-9466	49
NAD-32767	9561	1T15M6	Composite	WC1-358-1606	W01-358-9649	54
NAD-32768	9560	1T15M6	Composite	WC1-358-1620	W01-358-9213	48
NAD-32768	9560	1T15M6	Composite	WC1-358-1620	W01-358-9219	48
NAD-32768	9560	1T15M6	Composite	WC1-358-1620	W01-358-9296	49
NAD-32768	9560	1T15M6	Composite	WC1-358-1620	W01-358-9371	53
NAD-33165	9699	1T17BM6	Aluminum	N/A	W01-358-8673	76
NAD-33610	9562	1T19L9	Composite	N/A	W01-358-8980	82
NAD-33610	9562	1T19L9	Composite	N/A	W01-358-9280	83
NAD-33610	9562	1T19L9	Composite	N/A	W01-358-9985	86
NAD-34318	3894	1T19G5	Aluminum	N/A	W01-M58-8798	89
NAD-34837	3881	1T15MP6	Composite	N/A	W01-M58-7074	62
NAD-34837	3881	1T15MP6	Composite	N/A	W01-M58-8608	80
NAD-35451	9565	1T15	Composite	N/A	W01-358-9049	29
NAD-35451	9565	1T15 7	Composite	N/A	W01-358-9285	30
NAD-35451	9565	1T15	Composite	N/A	W01-358-9652	31
NAD-35451	9566	1T15	Composite	N/A	W01-358-9017	29
NAD-35451	9566	1T15	Composite	N/A	W01-358-9073	29
NAD-35451	9566	1T15	Composite	N/A	W01-358-9290	30
NAD-35451	9566	1T15	Composite	N/A	W01-358-9539	30
NAD-35451	9566	1T15	Composite	N/A	W01-358-9592	30
NAD-35451	9566	1T15	Composite	N/A	W01-358-9595	31
NAD-35451	9567	1T15	Aluminum	N/A	W01-358-8478	29
NAD-35451	9567	1T15	Aluminum	N/A	W01-358-9587	30
NAD-35451	9567	1T15	Aluminum	N/A	W01-358-9597	31
NAD-35451	9567	1T15	Aluminum	N/A	W01-358-9599	31
NAD-35451	9567	1T15	Aluminum	N/A	W01-358-9953	32
NAD-35550	9606	1T15M2	Aluminum	N/A	W01-358-1096	45
NAD-35550	9606	1T15M2	Aluminum	N/A	W01-358-8806	40
NAD-35550	9606	1T15M2	Aluminum	N/A	W01-358-8810	41
NAD-35550	9606	1T15M2	Aluminum	N/A	W01-358-9053	38
NAD-35550	9606	1T15M2	Aluminum	N/A	W01-358-9070	42
NAD-35550	9606	1T15M2	Aluminum	N/A	W01-358-9118	38
NAD-35550	9606	1T15M2	Aluminum	N/A	W01-358-9439	24

PRIMARY TRUCK & TRAILER

INDEX BY PISTON DRAWING NUMBER

PISTON DRAWING NO.	PISTON COMP. NO.	PISTON TYPE	PISTON MATERIALS	PISTON AON	FIRESTONE AON	PAGE NO.
NAD-35550	9606	1T15M2	Aluminum	N/A	W01-358-9441	24
NAD-35550	9606	1T15M2	Aluminum	N/A	W01-358-9797	44
NAD-35550	9606	1T15M2	Composite	WC1-358-1652	W01-358-9105	38
NAD-35550	9656	1T15M2	Aluminum	N/A	W01-358-9118	38
NAD-35551	9607	1T19E1	Aluminum	WC1-358-9450	W01-358-8778	81
NAD-35551	9607	1T19E1	Aluminum	WC1-358-9450	W01-358-8779	84
NAD-35551	9607	1T19E1	Aluminum	WC1-358-9450	W01-358-8780	84
NAD-35551	9607	1T19E1	Aluminum	WC1-358-9450	W01-358-9121	82
NAD-35551	9607	1T19E1	Aluminum	WC1-358-9450	W01-358-9134	84
NAD-35551	9607	1T19E1	Aluminum	WC1-358-9450	W01-358-9135	82
NAD-35551	9607	1T19E1	Aluminum	WC1-358-9450	W01-358-9138	85
NAD-35551	9607	1T19E1	Aluminum	WC1-358-9450	W01-358-9141	82
NAD-35551	9607	1T19E1	Aluminum	WC1-358-9450	W01-358-9144	82
NAD-35551	9607	1T19E1	Aluminum	WC1-358-9450	W01-358-9148	83
NAD-35551	9607	1T19E1	Aluminum	WC1-358-9450	W01-358-9149	83
NAD-35551	9607	1T19E1	Aluminum	WC1-358-9450	W01-358-9177	83
NAD-35551	9607	1T19E1	Aluminum	WC1-358-9450	W01-358-9221	83
NAD-35551	9607	1T19E1	Aluminum	WC1-358-9450	W01-358-9804	86
NAD-36702	9482	1T19E1	Aluminum	WC1-358-9450	W01-358-9135	82
NAD-37120	9639	1T15DR	Steel	N/A	W01-358-8525	19
NAD-37432	9586	1T15V5	Aluminum	WC1-358-1613	W01-358-8637	77
NAD-37432	9586	1T15V5	Aluminum	WC1-358-1613	W01-358-8740	74
NAD-37432	9586	1T15V5	Aluminum	WC1-358-1613	W01-358-8752	74
NAD-37432	9586	1T15V5	Aluminum	WC1-358-1613	W01-358-8753	74
NAD-37432	9586	1T15V5	Aluminum	WC1-358-1613	W01-358-9270	71
NAD-37989	3808	1T19E1	Aluminum	N/A	W01-M58-8775	88
NAD-37991	4034	1T19E2	Steel	N/A	W01-M58-6348	89
NAD-38033	9574	1T19E2	Aluminum	N/A	W01-M58-6339	86
NAD-38033	9574	1T19E2	Aluminum	N/A	W01-M58-6348	89
NAD-38338	9612	1T19E2	Aluminum	N/A	W01-358-8792	85
NAD-38338	9612	1T19F11	Composite	WC1-358-0528	W01-358-9122	85
NAD-38338	9612	1T19E2	Composite	WC1-358-0528	W01-358-9122	85
NAD-39259	9614	1T15ZR6	Aluminum	WC1-358-1624	W01-358-9781	72
NAD-39638	9477	1T15V11	Aluminum	WC1-358-1607	W01-358-9580	79
NAD-39638	9477	1T15V11	Aluminum	WC1-358-1607	W01-358-9581	79
NAD-39639	9476	1T15V11	Aluminum	N/A	W01-M58-8712	78
NAD-39687	4083	1T15V11	Aluminum	WC1-358-1607	W01-358-9580	79
NAD-39687	4083	1T15V11	Aluminum	WC1-358-1607	W01-358-9581	79

PRIMARY TRUCK & TRAILER
INDEX BY PISTON DRAWING NUMBER

PISTON DRAWING NO.	PISTON COMP. NO.	PISTON TYPE	PISTON MATERIALS	PISTON AON	FIRESTONE AON	PAGE NO.
NAD-40125	6781	1T15MP6	Composite	N/A	W01-M58-7074	62
NAD-40125	6781	1T15M	Composite	N/A	W01-M58-7074	62
NAD-40208	3808	1T19E1	Aluminum	N/A	W01-M58-8775	88
NBD-8055	9742	1T15M2	Aluminum	N/A	W01-358-9078	38
NBD-8626	6853	1T14C1	Aluminum	WC1-358-0600	W01-358-5405	13
NBD-8626	6853	1T14C1	Aluminum	WC1-358-0600	W01-358-5408	13
NBD-8626	9708	1T14C1	Aluminum	WC1-358-0600	W01-358-5310	12
NBD-8626	9708	1T14C1	Aluminum	WC1-358-0600	W01-358-5311	12
NBD-8626	9708	1T14C1	Aluminum	WC1-358-0600	W01-358-5323	13
NBD-8626	9708	1T14C1	Aluminum	WC1-358-0600	W01-358-5405	13
NBD-8626	9708	1T14C1	Aluminum	WC1-358-0600	W01-358-5406	13
NBD-8626	9708	1T14C1	Aluminum	WC1-358-0600	W01-358-5408	13
NBD-8626	9708	1T14C1	Aluminum	WC1-358-0600	W01-358-5422	14
NBD-8626	9708	1T14C1	Aluminum	WC1-358-0600	W01-358-5434	15
NBD-8626	9708	1T14C1	Aluminum	WC1-358-0600	W01-358-5710	17
NBD-8626	9708	1T14C1	Aluminum	WC1-358-0600	W01-358-5712	17
NBD-8724	9727	1T15M4	Aluminum	WC1-358-0651	W01-358-8805	40
NBD-8724	9727	1T15M4	Aluminum	WC1-358-0651	W01-358-9010	41
NBD-8724	9727	1T15M4	Aluminum	WC1-358-0651	W01-358-9056	42
NBD-8724	9727	1T15M4	Aluminum	WC1-358-0651	W01-358-9059	42
NBD-8724	9727	1T15M4	Aluminum	WC1-358-0651	W01-358-9071	42
NBD-8724	9727	1T15M4	Aluminum	WC1-358-0651	W01-358-9474	50
NBD-8724	9727	1T15M4	Aluminum	WC1-358-0651	W01-358-9491	70
NBD-8724	9727	1T15M4	Aluminum	WC1-358-0651	W01-358-9507	44
NBD-9253	9889	1T26D7	Aluminum	N/A	W01-358-9310	91
NBD-9253	9889	1T26D7	Aluminum	N/A	W01-358-9327	91
NBD-9611	9809	1T15L6	Aluminum	N/A	W01-358-9966	50
NBD-10378	3822	1T15M2	Aluminum	N/A	W01-358-8931	37
NBD-10378	3822	1T15M2	Aluminum	N/A	W01-358-9391	24
NBD-10378	6850	1T15M2	Aluminum	N/A	W01-358-9391	24
NBD-10436	9652	1T15M6	Aluminum	N/A	W01-358-9971	52
NBD-10436	9652	1T15M6	Aluminum	N/A	W01-358-9974	53
NBD-10437	9653	1T15M9	Aluminum	WC1-358-0620	W01-358-9106	57
NBD-10437	9653	1T15M9	Aluminum	WC1-358-0620	W01-358-9321	60
NBD-10437	9653	1T15M9	Aluminum	WC1-358-0620	W01-358-9367	60
NBD-10438	9654	1T15M0	Aluminum	WC1-358-0663	W01-358-9031	34
NBD-10438	9654	1T15M0	Aluminum	WC1-358-0663	W01-358-9036	34
NBD-10438	9654	1T15M0	Aluminum	WC1-358-0663	W01-358-9308	34

PRIMARY TRUCK & TRAILER

INDEX BY PISTON DRAWING NUMBER

PISTON DRAWING NO.	PISTON COMP. NO.	PISTON TYPE	PISTON MATERIALS	PISTON AON	FIRESTONE AON	PAGE NO.
NBD-10438	9654	1T15M0	Aluminum	WC1-358-0663	W01-358-9333	35
NBD-10438	9654	1T15M0	Aluminum	WC1-358-0663	W01-358-9334	35
NBD-10438	9654	1T15M0	Aluminum	WC1-358-0663	W01-358-9650	65
NBD-10439	9655	1T15M0	Aluminum	WC1-358-9454	W01-358-8963	33
NBD-10439	9655	1T15M0	Aluminum	WC1-358-9454	W01-358-9033	34
NBD-10439	9655	1T15M0	Aluminum	WC1-358-9454	W01-358-9039	34
NBD-10439	9655	1T15M0	Aluminum	WC1-358-9454	W01-358-9423	66
NBD-10440	9656	1T15M2	Aluminum	N/A	W01-358-1096	45
NBD-10440	9656	1T15M2	Aluminum	N/A	W01-358-8806	40
NBD-10440	9656	1T15M2	Aluminum	N/A	W01-358-8810	41
NBD-10440	9656	1T15M2	Aluminum	N/A	W01-358-9053	38
NBD-10440	9656	1T15M2	Aluminum	N/A	W01-358-9070	42
NBD-10440	9656	1T15M2	Aluminum	N/A	W01-358-9118	38
NBD-10440	9656	1T15M2	Aluminum	N/A	W01-358-9439	24
NBD-10440	9656	1T15M2	Aluminum	N/A	W01-358-9441	24
NBD-10440	9656	1T15M2	Aluminum	N/A	W01-358-9797	44
NBD-10472	9659	1T15T3	Aluminum	N/A	W01-358-8597	28
NBD-10472	9659	1T15T3	Aluminum	N/A	W01-358-8916	23
NBD-10472	9659	1T15T3	Aluminum	N/A	W01-358-8922	23
NBD-10472	9659	1T15T3	Aluminum	N/A	W01-358-8941	23
NBD-10472	9659	1T15T3	Aluminum	N/A	W01-358-9445	21
NBD-10472	9659	1T15T3	Aluminum	N/A	W01-358-9447	21
NBD-10472	9659	1T15T3	Aluminum	N/A	W01-358-9448	21
NBD-10472	9659	1T15T3	Aluminum	N/A	W01-358-9457	21
NBD-10472	9659	1T15T3	Aluminum	N/A	W01-358-9459	22
NBD-10472	9659	1T15T3	Aluminum	N/A	W01-358-9477	22
NBD-11498	9651	1T14C3	Aluminum	WC1-358-9095	W01-358-2120	12
NBD-11498	9651	1T14C3	Aluminum	WC1-358-9095	W01-358-5343	13
NBD-11498	9651	1T14C3	Aluminum	WC1-358-9095	W01-358-5354	16
NBD-11498	9651	1T14C3	Aluminum	WC1-358-9095	W01-358-5423	14
NBD-11498	9651	1T14C3	Aluminum	WC1-358-9095	W01-358-8868	16
NBD-11689	9754	1T14C7	Aluminum	WC1-358-1603	W01-358-5429	18
NBD-11689	9754	1T14C7	Aluminum	WC1-358-1603	W01-358-5439	16
NBD-11689	9754	1T14C7	Aluminum	WC1-358-1603	W01-358-5702	17
NBD-11689	9754	1T14C7	Aluminum	WC1-358-1603	W01-358-8977	16
NBD-11689	9754	1T14C7	Aluminum	WC1-358-1603	W01-358-8979	17
NBD-12639	9663	1T15L2	Aluminum	N/A	W01-358-9379	27
NBD-12639	9663	1T15	Aluminum	N/A	W01-358-9565	27

PRIMARY TRUCK & TRAILER
INDEX BY PISTON DRAWING NUMBER

PISTON DRAWING NO.	PISTON COMP. NO.	PISTON TYPE	PISTON MATERIALS	PISTON AON	FIRESTONE AON	PAGE NO.
NBD-12639	9663	1T15 2	Aluminum	N/A	W01-358-9566	27
NBD-12639	9663	1T15 2	Aluminum	N/A	W01-358-9567	27
NBD-12639	9663	1T15	Aluminum	N/A	W01-358-9568	28
NBD-14213	9681	1T15Y1	Aluminum	N/A	W01-358-5770	66
NBD-14213	9681	1T15Y1	Aluminum	N/A	W01-358-5772	66
NBD-14213	9681	1T15Y1	Aluminum	N/A	W01-358-5775	66
NBD-14213	9681	1T15Y1	Aluminum	N/A	W01-358-5776	67
NBD-14213	9681	1T15Y1	Aluminum	N/A	W01-358-5777	67
NBD-14213	9681	1T15Y1	Aluminum	N/A	W01-358-5783	67
NBD-14213	9681	1T15Y1	Aluminum	N/A	W01-358-5789	67
NBD-14213	9681	1T15Y1	Aluminum	N/A	W01-358-9586	68
NBD-14404	9528	1T15V1	Composite	WC1-358-0667	W01-358-8737	77
NBD-14404	9528	1T15V1	Composite	WC1-358-0667	W01-358-8738	77
NBD-14404	9528	1T15V1	Composite	WC1-358-0667	W01-358-8991	37
NBD-14404	9528	1T15V1	Composite	WC1-358-0667	W01-358-9249	68
NBD-14404	9528	1T15V1	Composite	WC1-358-0667	W01-358-9578	68
NBD-14404	9528	1T15V1	Composite	WC1-358-0667	W01-358-9582	68
NBD-14503	9691	1T15L4	Aluminum	N/A	W01-358-9415	24
NBD-15201	9538	1T15M6	Composite	WC1-358-1628/ WC1-358-3715	W01-358-9654	54
NBD-15201	9538	1T15M6	Composite	WC1-358-1628/ WC1-358-3715	W01-358-9663	55
NBD-17119	4078	1T15Y1	Aluminum	N/A	W01-358-5770	66
NBD-17119	4078	1T15Y1	Aluminum	N/A	W01-358-5772	66
NBD-17119	4078	1T15Y1	Aluminum	N/A	W01-358-5775	66
NBD-17119	4078	1T15Y1	Aluminum	N/A	W01-358-5776	67
NBD-17119	4078	1T15Y1	Aluminum	N/A	W01-358-5777	67
NBD-17119	4078	1T15Y1	Aluminum	N/A	W01-358-5783	67
NBD-17119	4078	1T15Y1	Aluminum	N/A	W01-358-5789	67
NBD-17119	4078	1T15Y1	Aluminum	N/A	W01-358-9586	68
NDD-3581	9652	1T15M6	Aluminum	N/A	W01-358-9974	53
NDD-3581	9809	1T15L6	Aluminum	N/A	W01-358-9966	50

CAB & SEAT

BY MANUFACTURER

MANUFACTURER/ PART NO.	FIRESTONE ASSEMBLY ORDER NO.	PAGE NO.
3TS		
	W02-358-7046	130
	W02-358-7100	132
AIR FLEX		
	W02-358-7085	136
DURA FORM		
S13384	W02-358-7150	131
S16894	W02-358-7151	144
S20235	W02-358-7035	138
S20235	W02-358-7108	142
S5388	W02-358-7040	134
S6197	W02-358-4003	141
S8645	W02-358-7041	132
S9383	W02-358-7031	135
S9383	W02-358-7035	138
S9383	W02-358-7108	142
FORD		
F6HT5CO63BA	W02-358-7200	146
F6HT5CO63BA	W02-358-7201	131
FREIGHTLINER		
660033406	W02-358-7205	143
1840977000	W02-358-7215	144
1842609000	W02-358-7200	146
1843472000	W02-358-7204	136
1845068000	W02-358-7201	131
1852651000	W02-358-7215	144
1852651001	W02-358-7215	144
18-29919-000	W02-358-7206	138
18-40977-000	W02-358-7215	144
18-42609-000	W02-358-7200	146
18-45068-000	W02-358-7201	131
1829919999REVC	W02-358-7206	138
	W02-358-7087	138
	W02-358-7200	146
	W02-358-7201	131
	W02-358-7204	136
	W02-358-7205	143
FREIGHTLINER/WESTERN STAR		
	W02-358-7082	143

MANUFACTURER/ PART NO.	FIRESTONE ASSEMBLY ORDER NO.	PAGE NO.
HENDRICKSON		
640752	W26-358-9912	151
663492	W26-358-9913	151
673042	W26-358-9913	151
57QL55M	W26-358-9913	151
59823-2	W26-358-9911	151
598232C	W26-358-9911	151
60750-2	W26-358-9913	151
607502E	W26-358-9913	151
697822A	W26-358-9911	151
H607502	W26-358-9913	151
KENWORTH		
T2000	W02-358-7110	146
KNOEDLER		
9212	W02-358-7040	134
LINK		
11010031	W02-358-7115	137
11020022	W02-358-7046	130
11020025	W02-358-7086	130
11020026	W02-358-7079	130
11020027	W02-358-7098	133
11020030	W02-358-7106	135
11020031	W02-358-7080	136
11020043	W02-358-7056	140
11020047	W02-358-7074	139
11020048	W02-358-7075	138
11020074	W02-358-7064	142
11020075	W02-358-7108	142
11020076	W02-358-7081	145
11020081	W02-358-7083	146
11020083	W02-358-7092	145
11030504	W02-358-9904	141
1101A043	W02-358-7081	145
1102K083	W02-358-7092	145
1103A043	W02-358-7081	145
1104k002	W02-358-7109	142
	W26-358-9902	150

CAB & SEAT
BY MANUFACTURER

MANUFACTURER/ PART NO.	FIRESTONE ASSEMBLY ORDER NO.	PAGE NO.
11010030	W02-358-7116	137
11010043	W02-358-7081	145
11020021	W02-358-7046	130
11020040	W02-358-7012	139
11020041	W02-358-7042	140
11020042	W02-358-7045	140
11020046	W02-358-7035	138
11020046	W02-358-7108	142
11020070	W02-358-7014	144
11020071	W02-358-7024	143
11020077	W02-358-7109	142
11020082	W02-358-7110	146
1102K077	W02-358-7109	142
1102K082	W02-358-7110	146
R811002	W02-358-7110	146
T811000	W02-358-7109	142
T811001	W02-358-7092	145
MACK		
227QS33	W02-358-7031	135
227QS33	W02-358-7035	138
227QS34	W02-358-7007	136
227QS38	W02-358-7017	141
57QL55M	W26-358-9913	151
NATIONAL SEATING		
2112283	W02-358-7055	134
2123403	W02-358-7070	137
32466201	W02-358-7058	133
32466301	W02-358-7059	132
32803501	W02-358-7059	132
32966601	W02-358-7059	132
329666-01, 328035-01, 324663-01	W02-358-7059	132
W02N197160	W02-358-7070	137
	W02-358-7058	133
PACCAR		
B816023	W26-358-9933	151

MANUFACTURER/ PART NO.	FIRESTONE ASSEMBLY ORDER NO.	PAGE NO.
PETERBILT		
202031	W02-358-9901	141
2902454	W02-358-7036	143
2903200	W02-358-7036	143
2905900	W02-358-7093	145
2906016	W02-358-7093	145
R816000	W02-358-7093	145
R816003	W02-358-7132	132
T816000	W02-358-7036	143
T816002	W02-358-7064	142
SEARS		
S13384	W02-358-7150	131
S16894	W02-358-7151	144
S6197	W02-358-4003	141
S9383	W02-358-7025	137
S9383	W02-358-7035	138
SEATS		
707338	W02-358-7040	134
708015	W02-358-7208	140
708220	W02-358-7209	135
VOLVO		
20462934	W26-358-9913	151
20897204	W26-358-9913	151
660033406	W02-358-7205	143
WATSON & CHALIN		
AS0085	W02-358-7038	142
WISE		
	W02-358-7054	133

CAB & SEAT

INDEX BY CAP DRAWING NUMBER

CAP DRAWING NUMBER	CAP COMPONENT NUMBER	MATERIAL	FIRESTONE AONs	PAGE NO.
FIP-100102	6978	Composite	W02-358-7208	140
NAD-25400	7066	Composite	W02-358-9901	141
NAD-25400	7066	Composite	W02-358-9904	141
NBD-9930	7005	Aluminum	W02-358-7007	136
NBD-10010	7007	Aluminum	W02-358-7010	133
NBD-10010	7007	Aluminum	W02-358-7012	139
NBD-10010	7007	Aluminum	W02-358-7014	144
NBD-10010	7007	Aluminum	W02-358-7017	141
NBD-10010	7007	Aluminum	W02-358-7024	143
NBD-10049	7009	Aluminum	W02-358-4003	141
NBD-10082	7014	Aluminum	W02-358-7002	131
NBD-10082	7014	Aluminum	W02-358-7031	135
NBD-10082	7014	Aluminum	W02-358-7036	143
NBD-10082	7014	Aluminum	W02-358-7139	145
NBD-10183	7013	Aluminum	W02-358-7018	130
NBD-10183	7013	Aluminum	W02-358-7025	137
NBD-10183	7013	Aluminum	W02-358-7037	139
NBD-10183	7013	Aluminum	W02-358-7038	142
NBD-10183	7013	Aluminum	W02-358-7043	144
NBD-10183	7013	Aluminum	W02-358-7073	135
NBD-10183	7013	Aluminum	W02-358-7085	136
NBD-10218	7018	Composite	W02-358-7001	131
NBD-10218	7018	Composite	W02-358-7054	133
NBD-10218	7018	Composite	W02-358-7064	142
NBD-10218	7018	Composite	W02-358-7075	138
NBD-10218	7018	Composite	W02-358-7082	143
NBD-10218	7018	Composite	W02-358-7086	130
NBD-10218	7018	Composite	W02-358-7092	145
NBD-10218	7018	Composite	W02-358-7110	146
NBD-10218	7018	Composite	W02-358-7132	132
NBD-10218	7018	Composite	W02-358-7200	146
NBD-10218	7018	Composite	W02-358-7201	131
NBD-10239	7015	Composite	W02-358-7040	134
NBD-10239	7015	Composite	W02-358-7041	132
NBD-10239	7015	Composite	W02-358-7042	140

INDEX BY CAP DRAWING NUMBER

CAP DRAWING NUMBER	CAP COMPONENT NUMBER	MATERIAL	FIRESTONE AONs	PAGE NO.
NBD-10239	7015	Composite	W02-358-7080	136
NBD-10239	7015	Composite	W02-358-7083	146
NBD-10239	7015	Composite	W02-358-7150	131
NBD-10409	7042	Composite	W02-358-7045	140
NBD-10409	7042	Composite	W02-358-7055	134
NBD-10409	7042	Composite	W02-358-7058	133
NBD-10409	7042	Composite	W02-358-7059	132
NBD-10409	7042	Composite	W02-358-7061	139
NBD-10409	7042	Composite	W02-358-7070	137
NBD-10409	7042	Composite	W02-358-7087	138
NBD-10409	7042	Composite	W02-358-7209	135
NBD-10470	7068	Composite	W02-358-7035	138
NBD-10470	7068	Composite	W02-358-7046	130
NBD-10470	7068	Composite	W02-358-7049	134
NBD-10470	7068	Composite	W02-358-7100	132
NBD-10470	7068	Composite	W02-358-7108	142
NBD-10470	7068	Composite	W02-358-7149	134
NBD-10470	7068	Composite	W02-358-7151	144
NBD-10604	7050	Composite	W02-358-7081	145
NBD-10604	7050	Composite	W02-358-7115	137
NBD-10604	7050	Composite	W02-358-7116	137
NBD-11636	7074	Composite	W02-358-7079	130
NBD-13262	6997	Composite	W02-358-7056	140
NBD-13262	6997	Composite	W02-358-7074	139
NBD-13262	6997	Composite	W02-358-7098	133
NBD-13262	6997	Composite	W02-358-7106	135
NBD-13706	6990	Composite	W02-358-7109	142
NBD-13706	6990	Composite	W02-358-7204	136
NBD-14314	6991	Composite	W02-358-7093	145
NBD-15430	6987	Composite	W02-358-7205	143
NBD-15430	6987	Composite	W02-358-7206	138
NBD-15430	6987	Composite	W02-358-7215	144

CAB & SEAT

INDEX BY PISTON DRAWING NUMBER

PISTON DRAWING NUMBER	PISTON COMPONENT NUMBER	MATERIAL	FIRESTONE AON	PAGE NO.
FIP-100105	6979	Composite	W02-358-7209	135
FIP-102215	9637	Composite	W02-358-7055	134
FIP-102215	9637	Composite	W02-358-7056	140
FIP-102215	9637	Composite	W02-358-7106	135
FIP-102215	9637	Composite	W02-358-7110	146
FIP-102216	9638	Composite	W02-358-7045	140
FIP-102216	9638	Composite	W02-358-7054	133
FIP-102216	9638	Composite	W02-358-7074	139
FIP-102216	9638	Composite	W02-358-7098	133
FIP-102217	9636	Composite	W02-358-7040	134
FIP-102217	9636	Composite	W02-358-7041	132
FIP-102217	9636	Composite	W02-358-7042	140
FIP-102217	9636	Composite	W02-358-7049	134
FIP-102217	9636	Composite	W02-358-7080	136
FIP-102217	9636	Composite	W02-358-7081	145
FIP-102217	9636	Composite	W02-358-7083	146
FIP-102217	9636	Composite	W02-358-7116	137
FIP-102217	9636	Composite	W02-358-7151	144
FIP-102217	9636	Composite	W02-358-7208	140
NBD-10071	7023	Aluminum	W02-358-7010	133
NBD-10071	7023	Aluminum	W02-358-7012	139
NBD-10071	7023	Aluminum	W02-358-7014	144
NBD-10071	7023	Aluminum	W02-358-7017	141
NBD-10071	7023	Aluminum	W02-358-7024	143
NBD-10071	7023	Aluminum	W02-358-7043	144
NBD-10071	7023	Aluminum	W02-358-7073	135
NBD-10071	7023	Aluminum	W02-358-7085	136
NBD-10215 (replaced by FIP-102216)				
NBD-10238 (replaced by FIP-102217)				
NBD-10514	7044	Aluminum	W02-358-4003	141
NBD-10526 (replaced by FIP-102215)				
NBD-10549	7049	Aluminum	W02-358-7002	131
NBD-10549	7049	Aluminum	W02-358-7007	136
NBD-10549	7049	Aluminum	W02-358-7031	135
NBD-10552 (replaced by NBD-16538)				
NBD-10795	7054	Aluminum	W02-358-7018	130
NBD-10795	7054	Aluminum	W02-358-7025	137
NBD-10795	7054	Aluminum	W02-358-7037	139

INDEX BY PISTON DRAWING NUMBER

PISTON DRAWING NUMBER	PISTON COMPONENT NUMBER	MATERIAL	FIRESTONE AON	PAGE NO.
NBD-10795	7054	Aluminum	W02-358-7038	142
NBD-11340	7059	Composite	W02-358-9901	141
NBD-12708	6896	Composite	W02-358-7058	133
NBD-12708	6896	Composite	W02-358-7059	132
NBD-12708	6896	Composite	W02-358-7149	134
NBD-12802 (replaced by NBD-16536)				
NBD-12816 (replaced by NBD-16484)				
NBD-13499 (replaced by NBD-16510)				
NBD-13727 (replaced by NBD-16537)				
NBD-14218	6894	Composite	W02-358-7109	142
NBD-14589	6891	Composite	W02-358-7093	145
NBD-15431	6986	Composite	W02-358-7205	143
NBD-15431	6986	Composite	W02-358-7206	138
NBD-15431	6986	Composite	W02-358-7215	144
NBD-15764	6980	Composite	W02-358-9904	141
NBD-16484	6906	Aluminum	W02-358-7036	143
NBD-16484	6906	Aluminum	W02-358-7139	145
NBD-16510	6908	Composite	W02-358-7132	132
NBD-16536	6911	Composite	W02-358-7070	137
NBD-16536	6911	Composite	W02-358-7087	138
NBD-16537	6912	Composite	W02-358-7035	138
NBD-16537	6912	Composite	W02-358-7046	130
NBD-16537	6912	Composite	W02-358-7079	130
NBD-16537	6912	Composite	W02-358-7100	132
NBD-16537	6912	Composite	W02-358-7108	142
NBD-16537	6912	Composite	W02-358-7115	137
NBD-16537	6912	Composite	W02-358-7150	131
NBD-16538	6913	Composite	W02-358-7001	131
NBD-16538	6913	Composite	W02-358-7061	139
NBD-16538	6913	Composite	W02-358-7064	142
NBD-16538	6913	Composite	W02-358-7075	138
NBD-16538	6913	Composite	W02-358-7082	143
NBD-16538	6913	Composite	W02-358-7086	130
NBD-16538	6913	Composite	W02-358-7092	145
NBD-16538	6913	Composite	W02-358-7200	146
NBD-16538	6913	Composite	W02-358-7201	131
NBD-16538	6913	Composite	W02-358-7204	136

CAB & SEAT

INDEX BY CAP COMPONENT NUMBER

CAP COMPONENT NUMBER	CAP DRAWING NUMBER	MATERIAL	FIRESTONE AON	PAGE NUMBER
6978	FIP-100102	Composite	W02-358-7208	140
6987	NBD-15430	Composite	W02-358-7205	143
6987	NBD-15430	Composite	W02-358-7206	138
6987	NBD-15430	Composite	W02-358-7215	144
6990	NBD-13706	Composite	W02-358-7109	142
6991	NBD-14314	Composite	W02-358-7093	145
6997	NBD-13262	Composite	W02-358-7056	140
6997	NBD-13262	Composite	W02-358-7074	139
6997	NBD-13262	Composite	W02-358-7106	135
7005	NBD-9930	Aluminum	W02-358-7007	136
7007	NBD-10010	Aluminum	W02-358-7010	133
7007	NBD-10010	Aluminum	W02-358-7012	139
7007	NBD-10010	Aluminum	W02-358-7014	144
7007	NBD-10010	Aluminum	W02-358-7017	141
7007	NBD-10010	Aluminum	W02-358-7024	143
7009	NBD-10049	Aluminum	W02-358-4003	141
7013	NBD-10183	Aluminum	W02-358-7018	130
7013	NBD-10183	Aluminum	W02-358-7025	137
7013	NBD-10183	Aluminum	W02-358-7038	142
7013	NBD-10183	Aluminum	W02-358-7085	136
7014	NBD-10082	Aluminum	W02-358-7002	131
7014	NBD-10082	Aluminum	W02-358-7031	135
7014	NBD-10082	Aluminum	W02-358-7036	143
7014	NBD-10082	Aluminum	W02-358-7139	145
7015	NBD-10239	Composite	W02-358-7040	134
7015	NBD-10239	Composite	W02-358-7041	132
7015	NBD-10239	Composite	W02-358-7042	140
7015	NBD-10239	Composite	W02-358-7080	136
7015	NBD-10239	Composite	W02-358-7083	146
7015	NBD-10239	Composite	W02-358-7150	131
7018	NBD-10218	Composite	W02-358-7001	131
7018	NBD-10218	Composite	W02-358-7054	133
7018	NBD-10218	Composite	W02-358-7064	142
7018	NBD-10218	Composite	W02-358-7075	138
7018	NBD-10218	Composite	W02-358-7082	143

INDEX BY CAP COMPONENT NUMBER

CAP COMPONENT NUMBER	CAP DRAWING NUMBER	MATERIAL	FIRESTONE AON	PAGE NUMBER
7018	NBD-10218	Composite	W02-358-7086	130
7018	NBD-10218	Composite	W02-358-7092	145
7018	NBD-10218	Composite	W02-358-7110	146
7018	NBD-10218	Composite	W02-358-7132	132
7018	NBD-10218	Composite	W02-358-7200	146
7018	NBD-10218	Composite	W02-358-7201	131
7042	NBD-10409	Composite	W02-358-7045	140
7042	NBD-10409	Composite	W02-358-7055	134
7042	NBD-10409	Composite	W02-358-7058	133
7042	NBD-10409	Composite	W02-358-7059	132
7042	NBD-10409	Composite	W02-358-7061	139
7042	NBD-10409	Composite	W02-358-7070	137
7042	NBD-10409	Composite	W02-358-7087	138
7050	NBD-10604	Composite	W02-358-7081	145
7050	NBD-10604	Composite	W02-358-7115	137
7050	NBD-10604	Composite	W02-358-7116	137
7066	NAD-25400	Composite	W02-358-9901	141
7066	NAD-25400	Composite	W02-358-9904	141
7068	NBD-10470	Composite	W02-358-7035	138
7068	NBD-10470	Composite	W02-358-7046	130
7068	NBD-10470	Composite	W02-358-7100	132
7068	NBD-10470	Composite	W02-358-7108	142
7068	NBD-10470	Composite	W02-358-7149	134
7068	NBD-10470	Composite	W02-358-7151	144
7074	NBD-11636	Composite	W02-358-7079	130
6990	NBD-13706	Composite	W02-358-7204	136
6997	NBD-13262	Composite	W02-358-7098	133
7013	NBD-10183	Aluminum	W02-358-7037	139
7013	NBD-10183	Aluminum	W02-358-7043	144
7013	NBD-10183	Aluminum	W02-358-7073	135
7042	NBD-10409	Composite	W02-358-7209	135
7068	NBD-10470	Composite	W02-358-7049	134

CAB & SEAT

INDEX BY PISTON COMPONENT NUMBER

PISTON COMPONENT NUMBER	PISTON DRAWING NUMBER	MATERIAL	FIRESTONE AON	PAGE NUMBER
6891	NBD-14589	Composite	W02-358-7093	145
6894	NBD-14218	Composite	W02-358-7109	142
6896	NBD-12708	Composite	W02-358-7058	133
6896	NBD-12708	Composite	W02-358-7059	132
6896	NBD-12708	Composite	W02-358-7149	134
6906	NBD-16484	Aluminum	W02-358-7036	143
6906	NBD-16484	Aluminum	W02-358-7139	145
6908	NBD-16510	Composite	W02-358-7132	132
6911	NBD-16536	Composite	W02-358-7070	137
6911	NBD-16536	Composite	W02-358-7087	138
6912	NBD-16537	Composite	W02-358-7035	138
6912	NBD-16537	Composite	W02-358-7046	130
6912	NBD-16537	Composite	W02-358-7079	130
6912	NBD-16537	Composite	W02-358-7100	132
6912	NBD-16537	Composite	W02-358-7108	142
6912	NBD-16537	Composite	W02-358-7115	137
6912	NBD-16537	Composite	W02-358-7150	131
6913	NBD-16538	Composite	W02-358-7001	131
6913	NBD-16538	Composite	W02-358-7061	139
6913	NBD-16538	Composite	W02-358-7064	142
6913	NBD-16538	Composite	W02-358-7075	138
6913	NBD-16538	Composite	W02-358-7082	143
6913	NBD-16538	Composite	W02-358-7086	130
6913	NBD-16538	Composite	W02-358-7092	145
6913	NBD-16538	Composite	W02-358-7200	146
6913	NBD-16538	Composite	W02-358-7201	131
6913	NBD-16538	Composite	W02-358-7204	136
6979	FIP-100105	Composite	W02-358-7209	135
6980	NBD-15764	Composite	W02-358-9904	141
6986	NBD-15431	Composite	W02-358-7205	143
6986	NBD-15431	Composite	W02-358-7206	138
6986	NBD-15431	Composite	W02-358-7215	144
6996 (replaced by 6908)				
6998 (replaced by 6911)				
7023	NBD-10071	Aluminum	W02-358-7010	133
7023	NBD-10071	Aluminum	W02-358-7012	139
7023	NBD-10071	Aluminum	W02-358-7014	144
7023	NBD-10071	Aluminum	W02-358-7017	141

INDEX BY PISTON COMPONENT NUMBER

PISTON COMPONENT NUMBER	PISTON DRAWING NUMBER	MATERIAL	FIRESTONE AON	PAGE NUMBER
7023	NBD-10071	Aluminum	W02-358-7024	143
7023	NBD-10071	Aluminum	W02-358-7043	144
7023	NBD-10071	Aluminum	W02-358-7073	135
7023	NBD-10071	Aluminum	W02-358-7085	136
7033 (replaced by 9636)				
7041 (replaced by 9638)				
7044	NBD-10514	Aluminum	W02-358-4003	141
7047 (replaced by 9637)				
7049	NBD-10549	Aluminum	W02-358-7002	131
7049	NBD-10549	Aluminum	W02-358-7007	136
7049	NBD-10549	Aluminum	W02-358-7031	135
7052 (replaced by 6913)				
7054	NBD-10795	Aluminum	W02-358-7018	130
7054	NBD-10795	Aluminum	W02-358-7025	137
7054	NBD-10795	Aluminum	W02-358-7037	139
7054	NBD-10795	Aluminum	W02-358-7038	142
7059	NBD-11340	Composite	W02-358-9901	141
7069 (replaced by 6906)				
7083 (replaced by 6912)				
9636	FIP-102217	Composite	W02-358-7040	134
9636	FIP-102217	Composite	W02-358-7041	132
9636	FIP-102217	Composite	W02-358-7042	140
9636	FIP-102217	Composite	W02-358-7049	134
9636	FIP-102217	Composite	W02-358-7080	136
9636	FIP-102217	Composite	W02-358-7081	145
9636	FIP-102217	Composite	W02-358-7083	146
9636	FIP-102217	Composite	W02-358-7116	137
9636	FIP-102217	Composite	W02-358-7151	144
9636	FIP-102217	Composite	W02-358-7208	140
9637	FIP-102215	Composite	W02-358-7055	134
9637	FIP-102215	Composite	W02-358-7056	140
9637	FIP-102215	Composite	W02-358-7106	135
9637	FIP-102215	Composite	W02-358-7110	146
9638	FIP-102216	Composite	W02-358-7045	140
9638	FIP-102216	Composite	W02-358-7054	133
9638	FIP-102216	Composite	W02-358-7074	139
9638	FIP-102216	Composite	W02-358-7098	133

OE SUSPENSION INDEX

MANUFACTURER NAME PART NUMBER	FIRESTONE AON	PAGE NO.
HENDRICKSON AUXILIARY HLM SERIES		
HL-015		
(Ride)	W01-358-8050	91
(Lift)	W01-358-7403	110
HLM-1&2		
(Ride)	W01-358-9367	60
(Lift)	W01-358-6935	101
MTL-45 & 50		
(Ride)	W01-358-9367	60
(Lift)	W01-358-6902	99
HENDRICKSON AUXILIARY HLN SERIES		
HLN (Truck)		
(Ride)	W01-358-8033	122
(Lift)	W01-358-7795	102
HLN (Trailer)		
(Ride)	W01-358-8042	127
(Lift)	W01-358-7795	102
HENDRICKSON AUXILIARY HLP SERIES		
HLP		
(Ride)	W01-358-8033	122
(Lift)	W01-358-7795	102
HLP (Trailer)		
(Ride)	W01-358-8042	127
(Lift)	W01-358-7795	102
HENDRICKSON AUXILIARY HLQ SERIES		
QS16A-X	W01-358-7403	110
QT20A-X		Call us
QU22C-X&QU22D-X	W01-358-9105	38
QW12A-X	W01-358-7136	106
HENDRICKSON AUXILIARY HLR SERIES		
ST-004		
(Ride)	W01-358-7843	125
(Lift)	W01-358-6902	99

MANUFACTURER NAME PART NUMBER	FIRESTONE AON	PAGE NO.
ST-031		
(Ride)	W01-358-7846	125
(Lift)	W01-358-6902	99
RT14D-X (Truck)		
(Ride)	W01-358-7847	125
(Lift)	W01-358-7403	110
RW14A-X		
(Ride)	W01-358-7843	125
(Lift)	W01-358-6902	99
RW14B-X&14C-X (trailer)		
(Ride)	W01-358-7847	125
(Lift)	W01-358-7403	110
HENDRICKSON AUXILIARY HLU SERIES		
HLU		
(Ride)	W01-358-8033	122
(Lift)	W01-358-7795	102
HLUS		
(Ride)	W01-358-8033	122
(Lift)	W01-358-7795	102
HLUH (ultra high lift)		
(Ride)	W01-358-7862	126
(Lift)	W01-358-7545	116
HLUR (pararev)		
(Ride)	W01-358-8033	122
(Lift)	W01-358-7897	103
HENDRICKSON TRAILER T-SERIES		
T-15-140, 150, 172, 244, 376	W01-358-8050	91
T-15-324	W01-358-8050	91
T-17-141, 174, 284	W01-358-8050	91
T-30-US-9,17	W01-358-9122	85
T-4-392	W01-358-9010	41
T-6-062	W01-358-9039	34
T-6-071	W01-358-9105	38
T-6-295	W01-358-9039	34

OE SUSPENSION INDEX

MANUFACTURER NAME PART NUMBER	FIRESTONE AON	PAGE NO.
T-6-370	W01-358-9039	34
T-6-422	W01-358-9039	34
T-9-084	W01-358-9122	85
T-9-106,278,313	W01-358-9082	46
T-9-175	W01-358-9158	86
T-9-325	W01-358-9092	46
T-9-390	W01-358-9092	46
TDC-014	W01-358-9039	34
TMB-14-120	W01-358-9082	46
TMB-17-135	W01-358-9082	46
HENDRICKSON TRAILER HT-SERIES		
HT190T	W01-358-9640	63
HT190U	W01-358-8944	61
HT230T	W01-358-9270	71
HT250T	W01-358-9265	61
HT250U	W01-358-9265	61
HT250U"Y"	W01-358-9265	61
HT-250U	W01-358-9299	64
HT-250U-Y (majority of versions)	W01-358-9265	61
HT-250U-Y	W01-358-9580	79
HT-250US	W01-358-9580	79
HT-250US	W01-358-9265	61
HT-250US	W01-358-9299	64
HT-300T (all)	W01-358-8050	91
HT-300U (all)	W01-358-9122	85
HENDRICKSON TRAILER INTRAAX SERIES		
AA230T	W01-358-8709	78
AA250T (reuse metal disk)	W01-358-8091	89
AA230L	W01-358-9626	25
AA230L	W01-358-9621	27
AA230L	W01-358-9619	28
AA250L	W01-358-9644	61
AA250L	W01-358-9646	61
AA250L	W01-358-9645	61

MANUFACTURER NAME PART NUMBER	FIRESTONE AON	PAGE NO.
HENDRICKSON TRAILER HT DOLLY		
HT Dolly	W01-358-9640	63
HT Dolly	W01-358-9270	71
HENDRICKSON TRAILER SLIDER BOX		
HS-190T	W01-358-9640	63
HS-230	W01-358-9270	71
HK-190T	W01-358-8755	75
HK-230	W01-358-8756	Call us
HENDRICKSON TRAILER VAN TRAAX		
HKA-180	W01-358-8713	78
HKA-180	W01-358-8709	78
HKA-200	W01-358-8708	78
HKA-250 (reuse metal disk)	W01-358-8091	89
HENDRICKSON TRAILER LIFTS		
CL	W01-358-7136	106
CL	W01-358-6801	107
HTCL	W01-358-7447	112
HENDRICKSON TRUCK		
HA360		
(up to 1991)	W01-358-9466	49
(1991 and up)	W01-358-9287	53
HA400		
(up to 1991)	W01-358-9466	49
(1991 and up)	W01-358-9287	53
HA460		
(up to 1991)	W01-358-9466	49
(1991 and up)	W01-358-9287	53
HAS40LH	W01-358-9297	53
HAS360	W01-358-9373	53
HAS400	W01-358-9373	53
HAS402	W01-358-9373	53
HAS460	W01-358-9373	53
AIRTEK 12K/12.6K/14.6K	W01-358-8597	28
PAX460	W01-358-9663	55

OE SUSPENSION INDEX

MANUFACTURER NAME PART NUMBER	FIRESTONE AON	PAGE NO.
HOLLAND LIFT SUSPENSIONS		
AL-40-US (Lift)	W01-358-7424	111
AL-41, AL-41-US (Lift)	W01-358-7424	111
AL-42, AL-42-US (Lift)	W01-358-7424	111
AL-45-9, 12, 14, 17 (Lift)	W01-358-7424	111
AL-50, AL-50US (Lift)	W01-358-7424	111
AL-70, AL-70-US (Lift)	W01-358-7424	111
AL-75-B, AL-76-A, AL-77, AL-78 (Lift)	W01-358-7135	106
ALT-40, ALT-40-L (Lift)	W01-358-7424	111
ALT-40-US, ALT-50-US, ALT-70-US (Lift)	W01-358-7424	111
ALT-500-US, ALT-550-US (Lift)	W01-358-7135	106
HOLLAND TRAILER AIR		
AR-41, AR-45, AR-45-1	W01-358-9039	34
AR-50-US, -F, -F-1, -F-2, AR-51-US	W01-358-9039	34
AR-70-9, AR-70-14	W01-358-9121	82
AR-70A-9, -14	W01-358-9121	82
AR-75-12, 1-12	W01-358-9101	57
AR-75-12, 1-12	W01-358-9346	59
AR-75-6, -9	W01-358-9082	46
AR-80-6.75	W01-358-9121	82
AR-80-9	W01-358-9134	84
AR-80-9FM	W01-358-9138	85
AR-80-9-WST	W01-358-9134	84
AR-85-A	W01-358-9121	82
AR-90-1-12	W01-358-9463	Call us
AR-90-1-14, 17	W01-358-9362	49
AR-90-1-15, 16	W01-358-9304	49
AR-90-14,15,16,17	W01-358-9243	58
AR-92-12, 14	W01-358-9921	51
AR-92-15	W01-358-9921	51
AR-92-16	W01-358-9921	51
AR-92-17	W01-358-9921	51
AR-92-18	W01-358-9921	51

MANUFACTURER NAME PART NUMBER	FIRESTONE AON	PAGE NO.
AR-93-14	W01-358-9921	51
AR-93-15	W01-358-9923	51
AR-93-16	W01-358-9923	51
AR-93-17	W01-358-9922	51
AR-120	W01-358-9082	46
AR-120-L	W01-358-9101	57
AR-120-US	W01-358-9082	46
AR-120-US-F	W01-358-9082	46
AR-120-US-L-1,2,3	W01-358-9101	57
AR-125	W01-358-9177	83
AR-125-L	W01-358-9158	86
AR-125-US	W01-358-9177	83
AR-125-US-F	W01-358-9121	82
AR-125-US-L-1,2,3	W01-358-9158	86
AR-165-US	W01-358-9082	46
AR-955-9, 12, 14, 17	W01-358-9122	85
AR-955-9-HD, 12-HD, 14-HD, 17-HD	W01-358-9122	85
AR-955A-9, 12, 14, 17	W01-358-9122	85
AR-955A-9-HD, 12-HD, 14-HD, 17-HD	W01-358-9122	85
AR-95-9,12,14,17	W01-358-9122	85
AR-95-9-HD, 12-HD, 14-HD, 17-HD	W01-358-9122	85
AR-95A-9,-12, -14, -17	W01-358-9122	85
AR-95A-9-HD, 12-HD, 14-HD, 17-HD	W01-358-9122	85
ARDST-246	W01-358-9121	82
ARL-20-D	W01-358-7437	111
ARL-20-D	W01-358-9039	34
ARL-20-D-US	W01-358-7437	111
ARL-20-D-US	W01-358-9039	34
ARU-92-10	W01-358-9243	58
ARU-92-8	W01-358-9921	51
ARU-92-9	W01-358-9243	58
ARU-93-6	W01-358-9921	51
ARU-93-7	W01-358-9921	51

OE SUSPENSION INDEX

MANUFACTURER NAME PART NUMBER	FIRESTONE AON	PAGE NO.
CB-2300	W01-358-9974	53
NS190	W01-358-9366	39
NS190-16	W01-358-8204	36
RL-196-12	W01-358-9294	32
RL-196-14	W01-358-9293	32
RL-196-15	W01-358-9295	33
RL-196-16	W01-358-9295	33
RL-196-17	W01-358-9291	32
RL-196A-14	W01-358-9293	32
RL-196A-15	W01-358-9295	33
RL-196A-16	W01-358-9295	33
RL-300	W01-358-8764	Call us
RL228-14, 15, 16	W01-358-9936	52
RL228-17	W01-358-8749	76
RL250-12,	W01-358-8749	76
RL250-14,15	W01-358-8748	76
RL250-16, 17	W01-358-8749	76
RLU-228 (12) -4	W01-358-9346	59
RLU-228 (6,7) -3	W01-358-9921	51
RLU-228 (8) -3	W01-358-9923	51
RLU-228 (8) -4	W01-358-9921	51
RLU-228 (9,10) -3	W01-358-9922	51
RLU-228 (9,10) -4	W01-358-9243	58
RLU-250 (12)	W01-358-8744	75
RLU-250 (6,75,9)	W01-358-8746	75
Intermodel	W01-358-9896	88
HOLLAND POWERED TRUCK		
AD-123,246(6.5,8.75)	W01-358-9472	69
AD-123,246(10)	W01-358-9471	69
AD-123,246(FORD)	W01-358-9472	69
AD-123	W01-358-9502	70
AD-123	W01-358-9501	70
AD-200(7)	W01-358-9482	43
AD-200(9)	W01-358-9496	50

MANUFACTURER NAME PART NUMBER	FIRESTONE AON	PAGE NO.
AD-200(11)	W01-358-9471	69
ADTB	W01-358-9697	44
ARDST-123/244-6	W01-358-9082	46
ARDST-244-6	W01-358-9193	47
ARDST-246-6, ARDST- M/L-246-6	W01-358-9121	82
ARDTB-125-6A	W01-358-8053	91
ARDAB-120-5, 240-5	W01-358-9268	63
ARD-120-6, ARD-238-6	W01-358-9082	46
ARD-125-6, 244-6	W01-358-9093	47
ARD-125-6, 244-6	W01-358-9082	46
ARD-125, -8, 244-8	W01-358-9082	46
ARD-165-A	W01-358-9082	46
ARD-165-B	W01-358-9082	46
ARD-190-B	W01-358-9082	46
ARL-20-D, -US	W01-358-7437	111
ARL-20-D, -US	W01-358-9039	34
HOLLAND NON-POWERED TRUCK		
ART-500-B, -B1	W01-358-9082	46
ART-500-US-A	W01-358-9082	46
ART-505-B, B-1	W01-358-9082	46
ART-505-C, C-1	W01-358-9082	46
ART-541-B	W01-358-9082	46
ART-550-US	W01-358-9082	46
ART-551-B-1, -2, -3	W01-358-9101	57
ART-551-US-1, -2, -3	W01-358-9101	57
ART-555-B-1, -2, -3	W01-358-9101	57
ART-555-C-1, -2, -3	W01-358-9101	57
IFS-114	W01-358-8198	36
TC-120-D	W01-358-9082	46
TC-120-D, -44	W01-358-9177	83

OE SUSPENSION INDEX

MANUFACTURER NAME PART NUMBER	FIRESTONE AON	PAGE NO.
WATSON CHALIN STEERING LIFTABLES		
LWSTL-1100		
(Ride)	W01-358-8008	120
(Lift)	W01-358-6897	99
STL-1100 TRU-TRACK		
(Ride)	W01-358-8032	122
(Lift)	W01-358-6897	99
STL-1800		
(Ride)	W01-358-7798	123
(Lift)	W01-358-6897	99
WATSON CHALIN TRAILER		
TA-250-14,15,16,17	W01-358-8753	74
TA-250U-12	W01-358-9243	58
TA-250U-14	W01-358-9243	58
TA-250U-5.5	W01-358-9243	58
TA-250U-7.5	W01-358-9243	58
TA-250U-7.5FS	W01-358-9243	58
TA-250U-9	W01-358-9243	58
TA-251-10	W01-358-9243	58
TA-251-12	W01-358-9243	58
TA-251-6.5FS	W01-358-9243	58
TA-251-7.5	W01-358-9243	58
TA-251-8FS	W01-358-9243	58
TA-251-9.0	W01-358-9243	58
TA-251-9.0 FS	W01-358-9243	58
TA-2590-12,14,15	W01-358-9243	58
TA-280-7.5	W01-358-9243	58
TA-280-9.0	W01-358-9243	58
TA-280D	W01-358-9039	34
TA-300-15	W01-358-8050	91
TA-300-16/17	W01-358-8050	91
TA-300-17	W01-358-8050	91
TA-300-22	W01-358-8050	91
TA-300-23B	W01-358-8050	91

MANUFACTURER NAME PART NUMBER	FIRESTONE AON	PAGE NO.
TA-300-9	W01-358-9121	82
TA-300FM-16B	W01-358-8050	91
TA-300U-12	W01-358-9122	85
TA-300U-14	W01-358-9122	85
TA-300U-17	W01-358-9122	85
TA-300U-9	W01-358-9122	85
TA-3090-14	W01-358-9121	82
TA-3090-17	W01-358-9122	85
TA-3090-19	W01-358-9122	85
TA-5000-DB-24	W01-358-8050	91
TA-5000-DB-30	W01-358-8050	91
TA-5000-F-24	W01-358-8050	91
TA-525DB	W01-358-8050	91
TA-525FS	W01-358-8050	91
TA-791	W01-358-9921	51
TA-791-17-B	W01-358-9243	58
TA-2075 (12)	W01-358-9101	57
TA-2075-9	W01-358-9082	46
WATSON CHALIN LIFTABLES		
TL-1100		
(Lift)	W01-358-6897	99
TL-2200-23 thru 34		
(Ride)	W01-358-9370	60
(Lift)	W01-358-6897	99
TL-2200-9 thru 20		
(Ride)	W01-358-9370	60
(Lift)	W01-358-6897	99
TL-2200LP		
(Lift)	W01-358-6897	99
(Ride)	W01-358-9243	58
TL-2200-SSR		
(Ride)	W01-358-9370	60
(Lift)	W01-358-6897	99

OE SUSPENSION INDEX

MANUFACTURER NAME PART NUMBER	FIRESTONE AON	PAGE NO.
TL-2590-12,14,15	W01-358-9243	58
TL-2590-14,17 HD	W01-358-9243	58
TL-2700-HD-14-ES	W01-358-6943	104
TL-800 (Ride)	W01-358-8032	122
TL-8100		
(Ride)	W01-358-8032	122
(Lift)	W01-358-6897	99
TL-9000-16B		
(Ride)	W01-358-8008	120
(Lift)	W01-358-6897	99
TL-9000-17.5/16.5		
(Ride)	W01-358-8008	120
(Lift)	W01-358-6897	99
TL-9000-19		
(Ride)	W01-358-8008	120
(Lift)	W01-358-6897	99
TL-9000-21		
(Ride)	W01-358-8008	120
(Lift)	W01-358-6897	99
TL-9000-24 (Ride)	W01-358-8008	120
TL-9000-30		
(Ride)	W01-358-8008	120
(Lift)	W01-358-6897	99
TLC-2590-12,14,15	W01-358-9243	58
TRU-TRACK		
(Ride)	W01-358-8008	120
(Lift)	W01-358-6897	99
WB-2500-6	W01-358-9105	38
WB-2500-7.5	W01-358-9082	46
WB-2500-9	W01-358-9082	46
WB-251-7.5	W01-358-9243	58
WB-251-9.0	W01-358-9243	58
WB-280-9.0	W01-358-9243	58

MANUFACTURER NAME PART NUMBER	FIRESTONE AON	PAGE NO.
WATSON CHALIN TRUCK		
AL-2200, -LW, -SSR, -RO		
(Lift)	W01-358-9219	48
(Ride)	W01-358-6897	99
SL-2200-13.5, -15		
(Lift)	W01-358-9370	60
(Ride)	W01-358-6897	99
AL-2200-LP		
(Lift)	W01-358-9370	60
(Ride)	W01-358-6897	99
AL-2200 ES		
(Ride)	W01-358-6897	99
AS-0048		
(Ride)	W01-358-7990	119

ALL PARTS

INDEX BY ASSEMBLY ORDER NUMBER

FIRESTONE AON	PAGE NO.
W01-358-0510	96
W01-358-0742	40
W01-358-0783	55
W01-358-1096	45
W01-358-1190	73
W01-358-1191	73
W01-358-1192	73
W01-358-2119	12
W01-358-2120	12
W01-358-2131	12
W01-358-3400	116
W01-358-3402	116
W01-358-3406	116
W01-358-3420	118
W01-358-5297	18
W01-358-5298	18
W01-358-5310	12
W01-358-5311	12
W01-358-5319	18
W01-358-5323	13
W01-358-5335	15
W01-358-5336	15
W01-358-5343	13
W01-358-5345	15
W01-358-5354	16
W01-358-5379	18
W01-358-5405	13
W01-358-5406	13
W01-358-5408	13
W01-358-5410	14
W01-358-5412	14
W01-358-5414	14
W01-358-5422	14
W01-358-5423	14
W01-358-5426	17
W01-358-5429	18

FIRESTONE AON	PAGE NO.
W01-358-5434	15
W01-358-5439	16
W01-358-5503	86
W01-358-5505	87
W01-358-5508	87
W01-358-5511	87
W01-358-5514	87
W01-358-5523	90
W01-358-5530	90
W01-358-5702	17
W01-358-5710	17
W01-358-5712	17
W01-358-5730	16
W01-358-5766	65
W01-358-5770	66
W01-358-5772	66
W01-358-5775	66
W01-358-5776	67
W01-358-5777	67
W01-358-5783	67
W01-358-5789	67
W01-358-5792	67
W01-358-5900	103
W01-358-6215	118
W01-358-6231	62
W01-358-6258	71
W01-358-6262	62
W01-358-6392	103
W01-358-6799	117
W01-358-6800	107
W01-358-6801	107
W01-358-6802	107
W01-358-6803	107
W01-358-6805	108
W01-358-6808	108
W01-358-6817	103

FIRESTONE AON	PAGE NO.
W01-358-6831	118
W01-358-6856	98
W01-358-6883	102
W01-358-6884	99
W01-358-6886	103
W01-358-6890	99
W01-358-6897	99
W01-358-6900	99
W01-358-6902	99
W01-358-6905	100
W01-358-6908	100
W01-358-6910	100
W01-358-6926	100
W01-358-6927	104
W01-358-6932	100
W01-358-6935	101
W01-358-6940	101
W01-358-6941	101
W01-358-6943	104
W01-358-6944	104
W01-358-6945	104
W01-358-6946	104
W01-358-6947	105
W01-358-6948	105
W01-358-6949	101
W01-358-6960	105
W01-358-6962	105
W01-358-6994	96
W01-358-7001	96
W01-358-7008	96
W01-358-7009	96
W01-358-7011	97
W01-358-7025	119
W01-358-7043	97
W01-358-7057	119
W01-358-7093	97

INDEX BY ASSEMBLY ORDER NUMBER

FIRESTONE AON	PAGE NO.
W01-358-7094	98
W01-358-7103	97
W01-358-7104	97
W01-358-7112	98
W01-358-7123	105
W01-358-7135	106
W01-358-7136	106
W01-358-7140	106
W01-358-7145	106
W01-358-7146	106
W01-358-7180	108
W01-358-7181	108
W01-358-7183	109
W01-358-7185	109
W01-358-7230	115
W01-358-7244	115
W01-358-7271	114
W01-358-7273	115
W01-358-7274	124
W01-358-7275	115
W01-358-7276	124
W01-358-7286	122
W01-358-7304	124
W01-358-7325	113
W01-358-7330	113
W01-358-7339	113
W01-358-7344	109
W01-358-7400	109
W01-358-7401	109
W01-358-7403	110
W01-358-7404	110
W01-358-7405	110
W01-358-7408	110
W01-358-7409	110
W01-358-7410	111
W01-358-7423	111

FIRESTONE AON	PAGE NO.
W01-358-7424	111
W01-358-7429	111
W01-358-7437	111
W01-358-7443	112
W01-358-7444	112
W01-358-7446	112
W01-358-7447	112
W01-358-7462	98
W01-358-7472	116
W01-358-7473	112
W01-358-7504	113
W01-358-7505	114
W01-358-7512	114
W01-358-7545	116
W01-358-7550	117
W01-358-7555	117
W01-358-7557	117
W01-358-7659	114
W01-358-7686	101
W01-358-7705	114
W01-358-7726	98
W01-358-7761	122
W01-358-7781	118
W01-358-7782	118
W01-358-7788	102
W01-358-7790	113
W01-358-7795	102
W01-358-7796	123
W01-358-7797	123
W01-358-7798	123
W01-358-7800	123
W01-358-7808	124
W01-358-7818	124
W01-358-7839	125
W01-358-7843	125
W01-358-7845	125

FIRESTONE AON	PAGE NO.
W01-358-7846	125
W01-358-7847	125
W01-358-7848	126
W01-358-7850	126
W01-358-7852	122
W01-358-7862	126
W01-358-7872	126
W01-358-7891	102
W01-358-7892	102
W01-358-7897	103
W01-358-7915	123
W01-358-7927	115
W01-358-7949	117
W01-358-7954	126
W01-358-7956	127
W01-358-7990	119
W01-358-7994	119
W01-358-7995	119
W01-358-7996	120
W01-358-8006	120
W01-358-8008	120
W01-358-8010	120
W01-358-8014	120
W01-358-8016	121
W01-358-8018	121
W01-358-8025	121
W01-358-8027	121
W01-358-8030	121
W01-358-8032	122
W01-358-8033	122
W01-358-8038	127
W01-358-8039	127
W01-358-8042	127
W01-358-8043	127
W01-358-8050	91
W01-358-8052	91

ALL PARTS

INDEX BY ASSEMBLY ORDER NUMBER

FIRESTONE AON	PAGE NO.
W01-358-8053	91
W01-358-8091	89
W01-358-8092	89
W01-358-8093	89
W01-358-8109	77
W01-358-8171	107
W01-358-8184	19
W01-358-8195	36
W01-358-8197	36
W01-358-8198	36
W01-358-8203	36
W01-358-8204	36
W01-358-8466	63
W01-358-8478	29
W01-358-8492	29
W01-358-8494	62
W01-358-8500	80
W01-358-8525	19
W01-358-8539	80
W01-358-8591	45
W01-358-8597	28
W01-358-8614	78
W01-358-8616	77
W01-358-8617	79
W01-358-8631	74
W01-358-8637	77
W01-358-8647	22
W01-358-8673	76
W01-358-8708	78
W01-358-8709	78
W01-358-8710	79
W01-358-8713	78
W01-358-8720	75
W01-358-8723	74
W01-358-8724	76
W01-358-8729	76

FIRESTONE AON	PAGE NO.
W01-358-8735	79
W01-358-8737	77
W01-358-8738	77
W01-358-8740	74
W01-358-8744	75
W01-358-8746	75
W01-358-8748	76
W01-358-8749	76
W01-358-8752	74
W01-358-8753	74
W01-358-8755	75
W01-358-8760	80
W01-358-8774	90
W01-358-8778	81
W01-358-8779	84
W01-358-8780	84
W01-358-8781	84
W01-358-8782	75
W01-358-8792	85
W01-358-8793	90
W01-358-8796	85
W01-358-8800	71
W01-358-8802	40
W01-358-8803	40
W01-358-8805	40
W01-358-8806	40
W01-358-8810	41
W01-358-8813	41
W01-358-8816	41
W01-358-8817	41
W01-358-8824	45
W01-358-8825	45
W01-358-8828	62
W01-358-8829	72
W01-358-8831	64
W01-358-8842	55

FIRESTONE AON	PAGE NO.
W01-358-8852	56
W01-358-8855	56
W01-358-8856	56
W01-358-8861	56
W01-358-8864	56
W01-358-8868	16
W01-358-8874	23
W01-358-8878	37
W01-358-8888	50
W01-358-8897	20
W01-358-8901	20
W01-358-8903	63
W01-358-8916	23
W01-358-8919	23
W01-358-8922	23
W01-358-8924	45
W01-358-8927	46
W01-358-8931	37
W01-358-8932	37
W01-358-8938	37
W01-358-8941	23
W01-358-8944	61
W01-358-8949	32
W01-358-8959	28
W01-358-8961	33
W01-358-8963	33
W01-358-8964	33
W01-358-8970	35
W01-358-8971	33
W01-358-8977	16
W01-358-8979	17
W01-358-8980	82
W01-358-8984	92
W01-358-8991	37
W01-358-8992	19
W01-358-8997	19

INDEX BY ASSEMBLY ORDER NUMBER

FIRESTONE AON	PAGE NO.
W01-358-9010	41
W01-358-9017	29
W01-358-9026	46
W01-358-9031	34
W01-358-9033	34
W01-358-9036	34
W01-358-9039	34
W01-358-9049	29
W01-358-9053	38
W01-358-9056	42
W01-358-9059	42
W01-358-9069	42
W01-358-9070	42
W01-358-9071	42
W01-358-9073	29
W01-358-9078	38
W01-358-9082	46
W01-358-9083	46
W01-358-9092	46
W01-358-9093	47
W01-358-9096	47
W01-358-9101	57
W01-358-9105	38
W01-358-9106	57
W01-358-9118	38
W01-358-9121	82
W01-358-9122	85
W01-358-9130	57
W01-358-9134	84
W01-358-9135	82
W01-358-9138	85
W01-358-9141	82
W01-358-9144	82
W01-358-9148	83
W01-358-9149	83
W01-358-9156	85

FIRESTONE AON	PAGE NO.
W01-358-9158	86
W01-358-9177	83
W01-358-9192	57
W01-358-9193	47
W01-358-9194	47
W01-358-9200	80
W01-358-9203	57
W01-358-9206	81
W01-358-9210	47
W01-358-9211	48
W01-358-9213	48
W01-358-9215	81
W01-358-9218	81
W01-358-9219	48
W01-358-9221	83
W01-358-9223	48
W01-358-9227	48
W01-358-9238	58
W01-358-9240	58
W01-358-9241	58
W01-358-9243	58
W01-358-9245	58
W01-358-9249	68
W01-358-9250	70
W01-358-9260	64
W01-358-9264	88
W01-358-9265	61
W01-358-9268	63
W01-358-9270	71
W01-358-9274	68
W01-358-9275	69
W01-358-9278	64
W01-358-9280	83
W01-358-9285	30
W01-358-9287	53
W01-358-9290	30

FIRESTONE AON	PAGE NO.
W01-358-9291	32
W01-358-9293	32
W01-358-9294	32
W01-358-9295	33
W01-358-9296	49
W01-358-9297	53
W01-358-9299	64
W01-358-9303	38
W01-358-9304	49
W01-358-9306	35
W01-358-9307	35
W01-358-9308	34
W01-358-9310	91
W01-358-9320	59
W01-358-9321	60
W01-358-9325	39
W01-358-9327	91
W01-358-9333	35
W01-358-9334	35
W01-358-9335	43
W01-358-9336	43
W01-358-9339	39
W01-358-9342	50
W01-358-9346	59
W01-358-9348	59
W01-358-9350	59
W01-358-9362	49
W01-358-9365	39
W01-358-9366	39
W01-358-9367	60
W01-358-9368	60
W01-358-9370	60
W01-358-9371	53
W01-358-9373	53
W01-358-9375	54
W01-358-9376	20

ALL PARTS

INDEX BY ASSEMBLY ORDER NUMBER

FIRESTONE AON	PAGE NO.
W01-358-9379	27
W01-358-9387	21
W01-358-9391	24
W01-358-9392	49
W01-358-9394	59
W01-358-9401	65
W01-358-9402	65
W01-358-9415	24
W01-358-9421	66
W01-358-9422	19
W01-358-9423	66
W01-358-9439	24
W01-358-9441	24
W01-358-9445	21
W01-358-9447	21
W01-358-9448	21
W01-358-9457	21
W01-358-9459	22
W01-358-9466	49
W01-358-9467	43
W01-358-9469	24
W01-358-9470	69
W01-358-9471	69
W01-358-9472	69
W01-358-9473	69
W01-358-9474	50
W01-358-9477	22
W01-358-9478	15
W01-358-9482	43
W01-358-9484	43
W01-358-9491	70
W01-358-9496	50
W01-358-9501	70
W01-358-9502	70
W01-358-9504	70
W01-358-9507	44

FIRESTONE AON	PAGE NO.
W01-358-9529	108
W01-358-9539	30
W01-358-9541	26
W01-358-9547	25
W01-358-9551	22
W01-358-9554	28
W01-358-9560	25
W01-358-9562	22
W01-358-9565	27
W01-358-9566	27
W01-358-9567	27
W01-358-9568	28
W01-358-9578	68
W01-358-9580	79
W01-358-9581	79
W01-358-9582	68
W01-358-9584	20
W01-358-9585	44
W01-358-9586	68
W01-358-9587	30
W01-358-9592	30
W01-358-9595	31
W01-358-9597	31
W01-358-9599	31
W01-358-9616	20
W01-358-9617	25
W01-358-9618	26
W01-358-9619	28
W01-358-9621	27
W01-358-9622	26
W01-358-9625	26
W01-358-9626	25
W01-358-9634	63
W01-358-9640	63
W01-358-9641	54
W01-358-9643	64

FIRESTONE AON	PAGE NO.
W01-358-9644	61
W01-358-9645	61
W01-358-9646	61
W01-358-9647	54
W01-358-9648	73
W01-358-9649	54
W01-358-9650	65
W01-358-9651	65
W01-358-9652	31
W01-358-9654	54
W01-358-9663	55
W01-358-9675	26
W01-358-9697	44
W01-358-9749	25
W01-358-9750	31
W01-358-9780	72
W01-358-9781	72
W01-358-9782	72
W01-358-9797	44
W01-358-9801	81
W01-358-9804	86
W01-358-9807	39
W01-358-9811	84
W01-358-9825	90
W01-358-9865	71
W01-358-9866	71
W01-358-9891	87
W01-358-9896	88
W01-358-9902	51
W01-358-9915	88
W01-358-9921	51
W01-358-9922	51
W01-358-9923	51
W01-358-9928	88
W01-358-9935	51
W01-358-9936	52

INDEX BY ASSEMBLY ORDER NUMBER

FIRESTONE AON	PAGE NO.
W01-358-9942	52
W01-358-9943	52
W01-358-9947	52
W01-358-9953	32
W01-358-9966	50
W01-358-9971	52
W01-358-9974	53
W01-358-9978	44
W01-358-9985	86
W01-M58-6339	86
W01-M58-6348	89
W01-M58-7074	62
W01-M58-8463	72
W01-M58-8468	73
W01-M58-8608	80
W01-M58-8712	78
W01-M58-8775	88
W01-M58-8798	89
W01-M58-9372	55
W01-M58-9656	55
W01-M58-9851	60
W02-358-4003	141
W02-358-7001	131
W02-358-7002	131
W02-358-7007	136
W02-358-7010	133
W02-358-7012	139
W02-358-7014	144
W02-358-7017	141
W02-358-7018	130
W02-358-7024	143
W02-358-7025	137
W02-358-7031	135
W02-358-7035	138
W02-358-7036	143
W02-358-7037	139

FIRESTONE AON	PAGE NO.
W02-358-7038	142
W02-358-7040	134
W02-358-7041	132
W02-358-7042	140
W02-358-7043	144
W02-358-7045	140
W02-358-7046	130
W02-358-7049	134
W02-358-7054	133
W02-358-7055	134
W02-358-7056	140
W02-358-7058	133
W02-358-7059	132
W02-358-7061	139
W02-358-7064	142
W02-358-7070	137
W02-358-7073	135
W02-358-7074	139
W02-358-7075	138
W02-358-7079	130
W02-358-7080	136
W02-358-7081	145
W02-358-7082	143
W02-358-7083	146
W02-358-7085	136
W02-358-7086	130
W02-358-7087	138
W02-358-7092	145
W02-358-7093	145
W02-358-7098	133
W02-358-7100	132
W02-358-7106	135
W02-358-7108	142
W02-358-7109	142
W02-358-7110	146
W02-358-7115	137

FIRESTONE AON	PAGE NO.
W02-358-7116	137
W02-358-7132	132
W02-358-7139	145
W02-358-7149	134
W02-358-7150	131
W02-358-7151	144
W02-358-7200	146
W02-358-7201	131
W02-358-7204	136
W02-358-7205	143
W02-358-7206	138
W02-358-7208	140
W02-358-7209	135
W02-358-7215	144
W02-358-9901	141
W02-358-9904	141
W26-358-9901	150
W26-358-9902	150
W26-358-9911	151
W26-358-9912	151
W26-358-9913	151
W26-358-9933	151
WC1-358-3874	92
WC1-358-3876	92
WC1-358-3900	92
WC1-358-3901	92
WC1-358-3901	92

Firestone

AIRIDE

TAKING DEPENDABILITY 100,000 MILES FURTHER

Introducing Firestone's new **INDUSTRY-BEST FIVE YEAR LIMITED WARRANTY**

We reviewed our warranty return rate history, and with rates below 0.02%, this warranty change will not increase distributor exposure for warranty return costs. We recognize the peace of mind our products bring to fleet owners and owner operators across North America, and our new warranty helps you continue to position the Firestone air spring line as the reliability the market needs.

AIR SPRING WARRANTY EVALUATION CRITERIA

Firestone air springs are designed to provide years and thousands of miles of trouble-free service. The durability of Firestone air springs is such that they will often outlast other maintenance items on your suspension, such as bushings, shocks, leveling valves, or regulators. Airide springs by Firestone are warranted to be free of material defects and/or workmanship for various periods of time, depending upon the application. Firestone Industrial Products Company offers a complete line of Airide springs, with replacement springs available for virtually every vehicular air suspension system. Since each individual air spring is closely examined and pressure tested at the factory, the vast majority of premature failures and consequent warranty returns are found not to be defective, but fail because of abuse caused by other problems associated with the suspension. Before you install a new air spring, you should carefully examine the old one to determine what caused it to fail. If it was due to a defect in the suspension system, then the new air spring may also fail unless you correct the problem. The information on the next two pages was developed to illustrate the types of failures that may occur, and to assist you in determining the cause and corrective action required.

When applied and maintained properly, Airide™ springs can provide thousands of miles of trouble-free service. Most failures are caused by a lack of suspension maintenance or improper application. This is a guide to common air spring failures that are **not covered by warranty.**

MISALIGNMENT



Appearance or Condition

- Off-center bumper contact
- Same as abrasion or bottoming out

Possible Causes

- Worn bushing
- Improper suspension

LOOSE GIRDLE HOOP

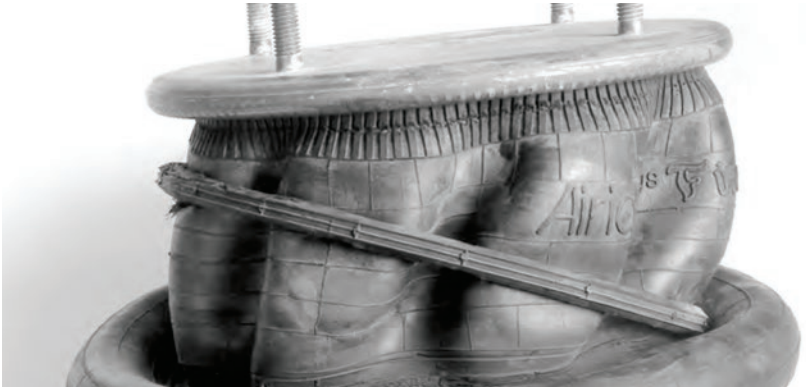

Appearance or Condition

- Rubber bellows distorted and girdle hoop torn loose

Possible Causes

- Running at extended positions with low air pressure

BOTTOMING OUT

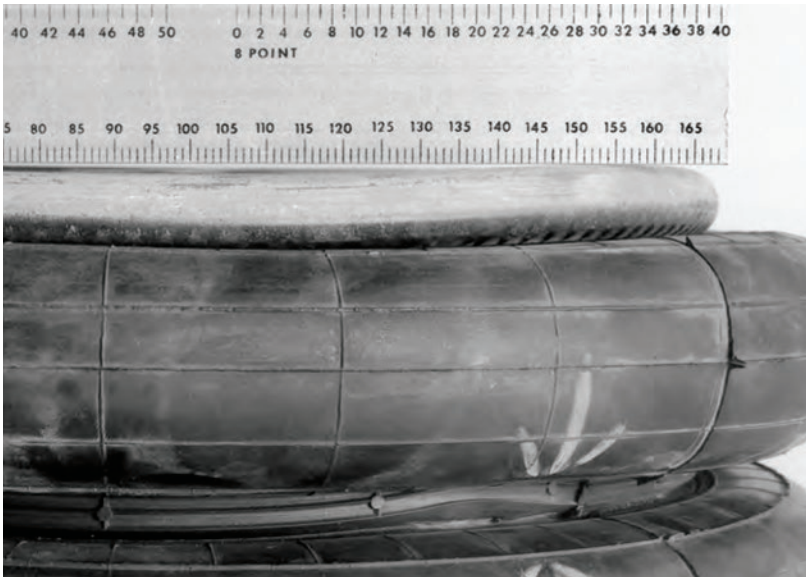

Appearance or Condition

- Bead plate concave
- Internal bumper loose
- Hole in girdle hoop area (convoluted)
- Hole in bead plate junction area
- Leaking around blind nuts

Possible Causes

- Broken or defective shock absorber
- Defective leveling valve
- Overloaded vehicle
- Pressure regulator set too low
- Wrong air spring (too tall)

ABRASION



Appearance or Condition

- Hole rubbed into side of bellows
- Hole in bellows area that rolls over piston (reversible sleeve style)

Possible Causes

- Structural interference, such as:
 - broken shock
 - loose air line
 - misalignment
 - worn bushings
- No air pressure (reversible sleeve style)
- Foreign material (sand, rocks, etc.)
- Wrong air spring

OVEREXTENSION

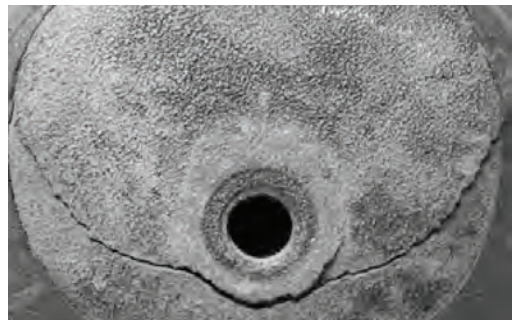
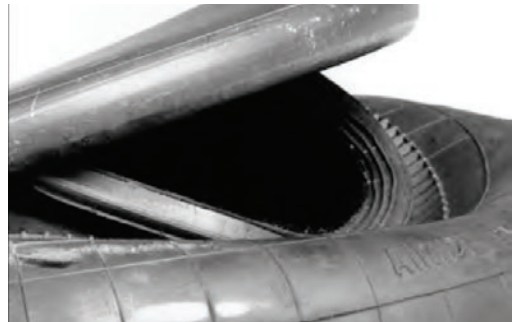
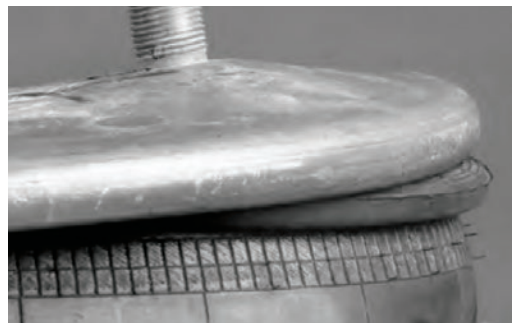

Appearance or Condition

- Bead plate convex, especially around blind nuts or studs
- Rubber bellows separated from bead plate
- Leaking at blind nuts or studs
- Leaking at end closure (reversible sleeve)
- Loose girdle hoop on convoluted style

Possible Causes

- Broken or wrong shock absorber
- Defective leveling valve
- Ride position too high
- Defective upper stop (lift)
- Wrong air spring (too short)

CIRCUMFERENTIAL CUTS



Appearance or Condition

- Bellows cut in circle at bead plate junction
- Bellows cut in circle at piston junction (reversible sleeve style)

Possible Causes

- High pressure, fully extended for long periods of time
- Impact in compressed position

Preventive Maintenance Checklist

Listed below are items that can be checked when the vehicle is in for periodic maintenance.

NEVER ATTEMPT TO SERVICE THE AIR SUSPENSION ON A TRUCK OR TRAILER WITH THE AIR SPRINGS INFLATED.

- 1** Inspect the O.D. of the air spring. Check for signs of irregular wear or heat cracking.

- 2** Inspect air lines to make sure contact doesn't exist between the air line and the O.D. of the air spring. Air lines can rub a hole in an air spring very quickly.

- 3** Check to see that there is sufficient clearance around the complete circumference of the air spring while at its maximum diameter.

- 4** Inspect the O.D. of the piston for buildup of foreign materials.

- 5** Correct ride height should be maintained. All vehicles with air springs have a specified ride height established by the O.E.M. manufacturer. This height, which is found in your service manual, should be maintained within 1/4". This dimension can be checked with the vehicle loaded or empty.

- 6** Leveling valves (or height control valves) play a large part in ensuring that the total air spring system works as required. Clean, inspect, and replace, if necessary.

- 7** Make sure you have the proper shock absorbers and check for leaking hydraulic oil and worn or broken end connectors. If a broken shock is found, replace it immediately. The shock absorber will normally limit the rebound of an air spring and keeps it from overextending.

- 8** Check the tightness of all mounting hardware (nuts and bolts). If loose, re-torque to the manufacturer's specifications. Do not over-tighten.

Cleaning

APPROVED: Approved cleaning media are soap and water, methyl alcohol, ethyl alcohol, and isopropyl alcohol.

NON-APPROVED: Non-approved cleaning media include all organic solvents, open flames, abrasives, and direct pressurized steam cleaning.

The total inspection process described on this page can be done in just a matter of minutes. If you find one of the above conditions exists, please take corrective action to ensure that it is fixed properly. This will save you both time and money over the long run.

Firestone

AIRIDE

AIR HELPER SPRINGS

KEEPS HEADLIGHTS
LEVELED UNDER LOAD

INCREASED STEERING
CONTROL & BRAKING

ENHANCES
RIDE COMFORT

PROTECTS CARGO
FROM BOTTOMING OUT

ADDS STABILITY TO
UNBALANCED LOADS

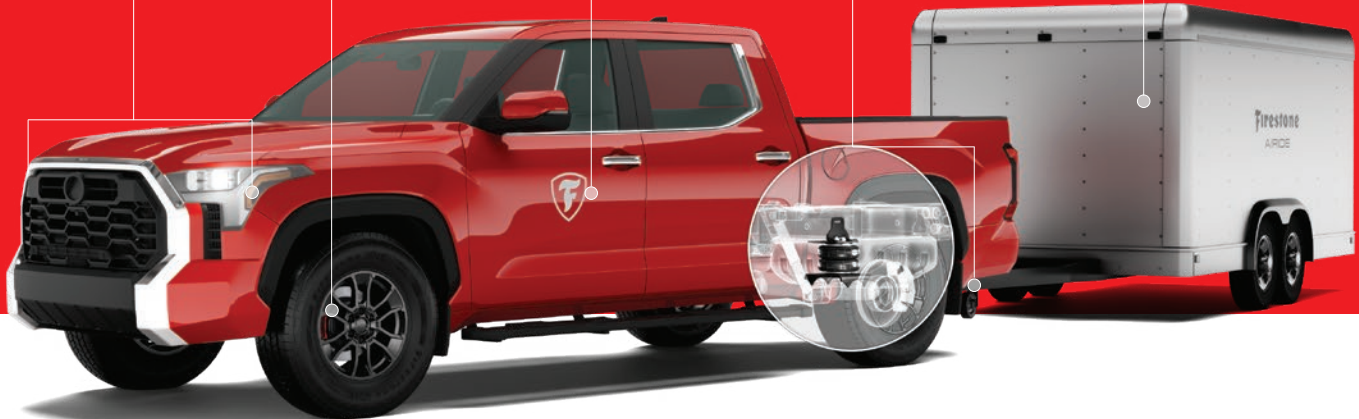

THE ADDED SUPPORT YOUR SUSPENSION NEEDS

Firestone Airide™ Helper Springs are engineered to maximize the safe load-carrying capacity of most trucks, motor-homes, SUVs, CUVs, and vans. When paired with Air Command™ single or dual-path wireless controls, Firestone Airide delivers a complete towing and hauling solution—making every trip smoother, safer, and virtually stress-free.



The Original Air Spring

📷 firestoneairide 📺 firestoneairide

www.firestoneairide.com



Firestone

AIRIDE

OFF-HIGHWAY PRODUCTS



AGRICULTURE



COMMERCIAL
LAUNDRY



CONSTRUCTION
& MINING



FORESTRY



MATERIAL
HANDLING



Learn more about our global reach at
www.firestoneairide.com/off-highway

📷 firestoneairide ▶️ firestoneairide





COMMERCIAL VEHICLE
AIR SPRINGS

Use our online air spring identification tool at
firestoneairide.com/product-search-hd-oh/



**PRIMARY TRUCK
& TRAILER AXLE**



AUXILIARY / TAG AXLE



CAB & SEAT



STEERING AXLE

firestoneairide.com

800-888-0650



DT4618